

Automation System TROVIS 5500 Heating and District Heating Controller TROVIS 5573



Mounting and Operating Instructions

EB 5573 EN

Firmware version 1.8x
Edition November 2008



Disclaimer of liability

We are constantly developing our products and therefore, reserve the right to change the product or the information contained in this document at any time without notice.

We do not assume any liability for the accuracy or completeness of these mounting and operating instructions. Moreover, we do not guarantee that the buyer can use the product for an intended purpose. SAMSON rejects any liability for claims by the buyer, especially claims for compensation including lost profits or any other financial loss, except the damage was caused intentionally or by gross negligence. If an essential term of the contract is breached by negligence, SAMSON's liability is limited to the foreseeable damage.

Important safety instructions

For your own safety, observe the following instructions on the installation, start up and operation of the controller:

- ▶ The device may only be installed, started up or operated by trained and experienced personnel familiar with the product.
- ▶ The controller has been designed for use in electrical power systems. For wiring and maintenance, you are required to observe the relevant safety regulations.

In addition, the following applies to prevent damage to the controller:

- ▶ Proper shipping and appropriate storage are assumed.

Definitions of the signal words used in these instructions

⚠ DANGER!

DANGER indicates a hazardous situation which, if not avoided, will result in death or serious injury.

NOTICE

NOTICE indicates a property damage message.

WARNING!

WARNING indicates a hazardous situation which, if not avoided, could result in death or serious injury.

Note: *Supplementary explanations, information and tips*

ContentsPage

1	Operation	6
1.1	Operating controls	6
1.1.1	Rotary pushbutton	6
1.1.2	Rotary switch	6
1.2	Operating modes	7
1.2.1	Setting the operating modes	7
1.3	Display	8
1.4	Opening the information level	9
1.5	Setting the controller time	10
1.6	Setting the times-of-use	11
1.7	Setting the party mode	13
1.8	Activating the extended information level	14
1.8.1	Setting public holidays	15
1.8.2	Setting vacation periods	16
1.9	Entering day and night set points	18
2	Start-up	20
2.1	Setting the system code number	20
2.2	Activating and deactivating functions	21
2.3	Changing parameters	23
2.4	Calibrating sensors	24
2.5	Resetting to default values	25
3	Manual mode	26
4	Systems	27
5	Functions of the heating circuit	46
5.1	Weather-compensated control	46
5.1.1	Gradient characteristic	47
5.1.2	4-point characteristic	49
5.2	Fixed set point control	50
5.3	Underfloor heating/drying of jointless floors	51
5.4	Deactivation depending on outdoor temperature	52
5.4.1	OT deactivation value in rated operation	52
5.4.2	OT deactivation value in reduced operation	52
5.4.3	OT activation value in rated operation	53
5.4.4	Summer mode	53
5.5	Delayed outdoor temperature adaptation	54
5.6	Remote operation	54
5.7	Optimization	55

5.8	Flash adaptation	56
5.8.1	Flash adaptation without outdoor sensor (room temperature dependent)	57
5.9	Adaptation	58
6	Functions of the DHW circuit	59
6.1	DHW heating in the storage tank system	59
6.1.1	DHW circuit additionally controlled by a globe valve	61
6.2	DHW heating in the storage tank charging system	62
6.3	DHW heating in instantaneous heating system	64
6.4	DHW heating with solar system	65
6.5	Intermediate heating operation	65
6.6	Parallel pump operation	65
6.7	Circulation pump operation during storage tank charging	66
6.8	Priority operation	66
6.8.1	Reverse control	66
6.8.2	Set-back operation	67
6.9	Forced charging of the DHW storage tank	67
6.10	Thermal disinfection of the DHW storage tank	68
7	System-wide functions	70
7.1	Automatic summer time/winter time changeover	70
7.2	Frost protection	70
7.3	Forced operation of the pumps	71
7.4	Return flow temperature limitation	71
7.5	Condensate accumulation control	72
7.6	Three-step control	73
7.7	On/off control	73
7.8	Continuous control in control circuit Rk1	73
7.9	Releasing a control circuit/controller over the binary input	74
7.10	Processing of external demand in control circuit Rk1	75
7.11	Creep feed rate limitation using a binary input	76
7.12	Locking manual level	76
7.13	Locking the rotary switch	77
7.14	Feeder pump operation	77
7.15	Setting a customized key number	77
8	Operational faults	78
8.1	Error list	78
8.2	Sensor failure	79
8.3	Temperature monitoring	79

8.4	Error status register	79
8.5	Sending text messages in case of error	80
9	Communication	82
9.1	RS-232/modem communications module	83
9.2	RS-485 communications module	84
9.3	Description of communication parameter settings	85
9.4	Memory module	86
9.5	Data logging	86
10	Installation	88
11	Electrical connection	90
12	Appendix	93
12.1	Function block lists	93
12.2	Parameter lists	103
12.3	Sensor resistance tables	112
12.4	Technical data	113
12.5	Customer data	114
	Index	121
	Key abbreviations	125

Modifications to controller firmware in comparison to previous version	
1.80 (previous)	1.82 (new)
	Internal modifications

1 Operation

The controller is ready for use with the default temperatures and operating schedules. On start-up, the **current time and date** need to be set at the controller (-> section 1.5).

1.1 Operating controls

The operating controls are located in the front panel of the controller.

1.1.1 Rotary pushbutton

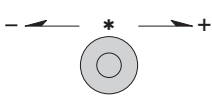

Rotary pushbutton

- Turn [⌚]:
Display, select parameters and function blocks
- Press [✱]:
Confirm adjusted selection or settings

1.1.2 Rotary switch

The rotary switch is used to set the operating mode and the relevant parameters for each control circuit.

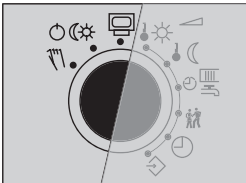

- Information level, rotary switch in normal position
- Operating modes
- Manual level

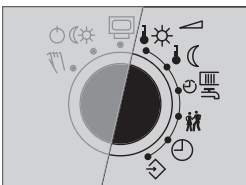

- Day set point (rated room temperature)
- Night set point (reduced room temperature)
- Times-of-use for heating/DHW
- Party mode
- Controller time
- Configuration and parameter level

1.2 Operating modes

Day mode (rated operation) ☼: Regardless of the programmed times-of-use and summer mode, the set points relevant for rated operation are used by the controller.

Night mode (reduced operation) ☾: Regardless of the programmed times-of-use, the set points relevant for reduced operation are used by the controller.

Stand-by mode ☉: Regardless of the programmed times-of-use, control operation is deactivated. Only the frost protection is activated, if need be.

Automatic mode ☺: During the programmed times-of-use, the controller works in rated operation. Outside these times-of-use, the controller is in reduced operation, unless control operation is deactivated depending on the outdoor temperature. The controller switches automatically between both operating modes.

Manual mode ☞: Valves and pumps can be controlled manually (-> section 3).

1.2.1 Setting the operating modes

1. Turn the rotary switch to ☉☼ (operating modes). ◀ blinks on the display.
 - ▶ For systems with just one control circuit (e.g. Anl 1.0), steps 2 and 3 can be skipped (selecting the control circuit).
2. Select the control circuit whose operating mode is to be set [☺]:
 - 1 Heating circuit 1
 - 2 Heating circuit 2
 - 3 DHW circuit/circulation pump (DHW)
 - ▶ Only those control circuits are available for selection which can be controlled by the system schematics (Anl) selected.
3. Confirm the control circuit [✱].
4. Select the operating mode [☺]: ☼, ☾, ☉ or ☺
5. Confirm the operating mode [✱].
6. Return the rotary switch to normal switch position ☐ (information level).

Note: In automatic mode, the momentary stage of the operating schedule (☼ for day mode or ☾ for night mode) is displayed in the information level together with the icon ☺.

1.3 Display

The display indicates the time as well as information about the operation of the controller when the rotary switch is at the normal position (information level). The times-of-use together with temperatures of the various control circuits can be viewed on the display by turning the rotary pushbutton. The times-of-use are represented by black squares below the row of numbers at the top of the display. Icons indicate the operating status of the controller.

⌚ Public holiday mode

⌋ Vacation mode

⚡ Operational fault

❄ Frost protection

0 1 2 3 4 5 6 7 8 9 10 11 12 13 14 15 16 17 18 19 20 21 22 23 24

16:55

1 Heating circuit 1

- ⌚ Automatic mode
- ⌋ Night mode
- ☀ Day mode
- ⌋ Manual mode
- ⏻ Stand-by mode
- ⊗ Circulation pump UP1*
- ▲❄ Valve Rk1 OPEN
- ❄▼ Valve Rk1 CLOSED

2 Heating circuit 2

- ⌚ Automatic mode
- ⌋ Night mode
- ☀ Day mode
- ⌋ Manual mode
- ⏻ Stand-by mode
- ⊗ Circulation pump UP2*
- ▲❄ Valve Rk2 OPEN
- ❄▼ Valve Rk2 CLOSED

3 DHW circuit

- ⌚ Automatic mode
- ⌋ Night mode
- ☀ Day mode
- ⌋ Manual mode
- ⏻ Stand-by mode
- ⊗ Pump output TLP/CP*
- ⊗ Storage tank charging pump SLP*
- ⊗ Circulation pump ZP*

* UP1, UP2, TLP, CP, SLP and ZP indicate possible choices for pump selection in manual mode.

Fig. 1 · Icons













The controller status can be displayed in the information level (-> section 1.4).

1.4 Opening the information level

At the normal switch position  (information level), the time, date, public holidays and vacation periods as well as the temperatures measured by the connected sensors and their set points can be retrieved and displayed.

Note: Data can also be viewed in the operating level  (manual mode).
To do so, select **Info**, confirm and proceed as described below.

Proceed as follows:

- Select value [].
Depending on the configuration of the controller, the current values of the following data points are displayed one after the other:
 -  Time
 -  Room temperature, heating circuits 1, 2
 -  Outdoor temperature
 -  Temperature at flow sensor VF, heating circuits 1, 2
 -  Temperature at flow sensor VF1, primary heat exchanger circuit
 -  Temperature at flow sensor VF2, VF4, DHW circuit
 -  Temperature at solar collector sensor VF3
 -  Temperature at return flow sensor RüF
 -  Temperature at storage tank sensor SF1
 -  Temperature at storage tank sensor SF2
 -  Temperature at storage tank sensor of the solar circuit
- By confirming a data point [] its set point/limit is displayed. When the time is indicated on the display, the date appears on pressing the rotary pushbutton.

1.5 Setting the controller time

The current time and date need to be set immediately after start-up and after a power failure of more than 24 hours has occurred. This is the case when the time blinks on the display.

Proceed as follows:

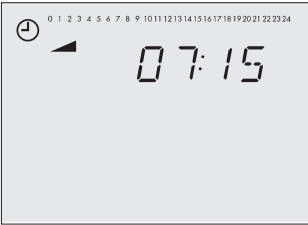

1. Turn the rotary switch to \oplus (controller time).
Display: time, \oplus and \blacktriangleleft blink.
2. Edit the controller time [\circlearrowleft].

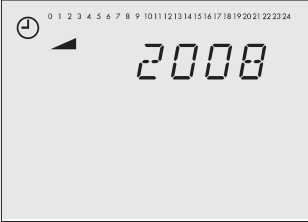

3. Confirm the adjusted time [*].
Display: year
4. Edit the year [\circlearrowleft].

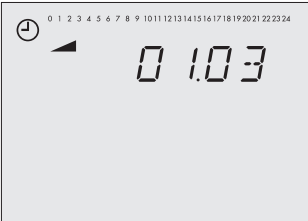

5. Confirm the adjusted year [*].
Display: date (day.month)
6. Edit the date [\circlearrowleft].
7. Confirm the adjusted date [*].
Display: time
8. Return the rotary switch to normal switch position  (information level).

1.6 Setting the times-of-use



Three times-of-use can be set for each day of the week.

Parameters	WE*	Range of values
Period/day	1-7	1-7, 1, 2, 3, 4, 5, 6, 7 with 1-7 = every day, 1 = Monday, 2 = Tuesday, ..., 7 = Sunday
Start first time-of-use	6:00	0:00 to 24:00h; in steps of 15 minutes
Stop first time-of-use	22:00	0:00 to 24:00h; in steps of 15 minutes
Start second time-of-use	22:15	0:00 to 24:00h; in steps of 15 minutes
Stop second time-of-use	22:15	0:00 to 24:00h; in steps of 15 minutes
Start third time-of-use	-	0:00 to 24:00h; in steps of 15 minutes
Stop third time-of-use	-	0:00 to 24:00h; in steps of 15 minutes

* Default values (WE) valid for heating circuits

Proceed as follows:

- Turn the rotary switch to  (times-of-use).
 ▲ blinks.
 - For systems with just one control circuit (e.g. Anl 1.0), steps 2 to 5 can be skipped (selecting the control circuit and specifying the DHW circuit).
 - Only the DHW circuit is controlled in systems Anl 1.5 and 1.9. Therefore the instructions steps 2 and 3 (selecting the control circuit) do not apply and can be skipped.
- Select the control circuit, for which the times-of-use are to be entered [↵]:
 - Heating circuit 1
 - Heating circuit 2
 - DHW circuit/circulation pump (DHW)
 - Only those control circuits are available for selection which can be controlled by the system (Anl) selected.
- Confirm the control circuit [*].
 - If control circuit 1 or 2 has been selected, skip steps 4 and 5.
- Specify DHW circuit [↵]:

 DHW heating /  Circulation pump (DHW)
- Confirm [*].

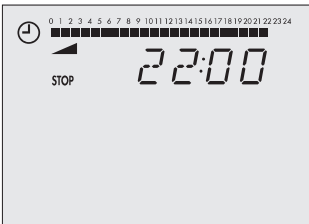
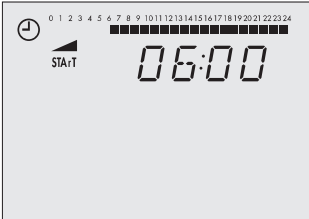
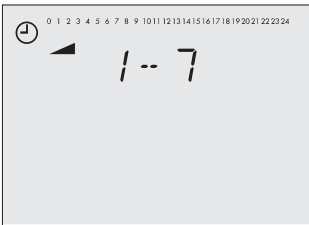

6. Select period/day for which the times-of-use are to be valid [⏸]:
 1-7 = every day,
 1 = Monday, 2 = Tuesday, ..., 7 = Sunday

7. Activate editing mode for period/day [*].
 Display: **START**, ⌚ and ◀ blink.
8. Edit start time [⏸].
 (in steps of 15 minutes)

9. Confirm start time [*].
 Display: **STOP**
10. Edit stop time [⏸].
 (in steps of 15 minutes)
11. Confirm stop time [*].
 Display: **START**
 The indicated time corresponds to the stop time for the first time-of-use plus 15 minutes.
 To set the second and third times-of-use, repeat steps 8 to 11.
 If no further times-of-use for the selected period/day are to be programmed, confirm the displayed start time twice (2x [*]).

For daily setting, repeat steps 6 to 11 in the same sequence.

Note: Do not use the 1-7 menu to check the programmed times-of-use.
 If this menu is opened after the times-of-use have been set, the schedule programmed for Monday is also adopted for all other days of the week.







12. After setting all times-of-use:
 Return the rotary switch to normal switch position  (information level).

1.7 Setting the party mode

Using the **Party mode** function, the controller continues or activates the day mode during the time when the party timer is active, regardless of the programmed times-of-use. When the party timer has elapsed, the party mode timer is reset to 00:00.

Parameter	WE	Range of values
Continue/activate rated operation	0 h	0 to 48 hours

Proceed as follows:

- Turn the rotary switch to  (party mode).
 blinks.
 - In systems AnI 1.0, 1.9 and 3.5, the display reads 00:00 or indicates the remaining time of party timer. Steps 2 and 3 can be skipped (selecting the control circuit).
- Select the control circuit in which the day mode is to continue or be activated []:
 - Heating circuit 1
 - Heating circuit 2
 - DHW circuit
 - Only those control circuits are available for selection which can be controlled by the system (AnI) selected.
- Confirm the control circuit [].
 Display: **00:00** or indicates the remaining time of party timer.
- Select how long the day mode is to continue running [].
 This setting is made in steps of 15 minutes.
- Return the rotary switch to normal switch position  (information level).

Note: The party timer counts down in steps of 15 minutes.

1.8 Activating the extended information level

If the extended information level is activated, further information can be viewed after the listed data points:

- ▶ Public holidays \sim (can be changed, see section 1.8.1)
- ▶ Vacation periods \ddagger (can be changed, see section 1.8.2)
- ▶ Valve positions
- ▶ Switching states of the binary inputs
- ▶ InFo 2: After confirming the level [*] the following data appear in the sequence shown below:

0 1 2 3 4 5 6 7 8 9 10 11 12 13 14 15 16 17 18 19 20 21 22 23 24 ■
0 1 2 3 4 5 6 7 8 9 10 11 12 13 14 15 16 17 18 19 20 21 22 23 24 ■
0 1 2 3 4 5 6 7 8 9 10 11 12 13 14 15 16 17 18 19 20 21 22 23 24 ■
0 1 2 3 4 5 6 7 8 9 10 11 12 13 14 15 16 17 18 19 20 21 22 23 24 ■

Controller ID

Memory capacity of data logging module (section 9.5)

255

Operating hours of solar circuit pump (refer to section 6.4)

Opening the extended information level:

1. Turn the rotary switch to \diamond (parameter and configuration level).
Display: **0000**, \blacktriangleleft blinks.
2. Set key number 1999 [\diamond].
3. Confirm key number [*].
Display: **0000**
4. Return the rotary switch to normal switch position \square (information level).

Note: The extended information level is deactivated when the key number 1999 is re-entered.





1.8.1 Setting public holidays

On public holidays, the times-of-use specified for Sunday apply.
A maximum of 20 public holidays may be entered.

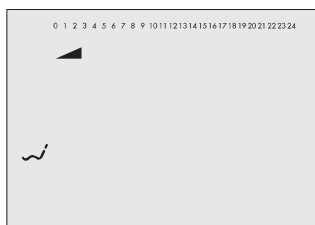
Parameter	WE	Level / Range of values
Public holidays	-	Extended information level/ 01.01 to 31.12

Proceed as follows:



1. In the extended information level (normal switch position ) select data point for public holidays [\odot].
Display: 
2. Open data point for public holidays.
3. If applicable, select - - - -.
4. Activate editing mode for public holiday [\ast].
 and  blink.
5. Select public holiday [\odot].
6. Confirm public holiday [\ast].

To enter additional public holidays, re-select - - . - - and repeat the steps 4 to 6.

Note: Public holidays can also be set in PA5 parameter level (-> section 2.3).

Deleting a public holiday:

1. Under data point for public holidays, select the holiday you wish to delete [\odot].
2. Confirm selection [\ast].
3. Select - -. - - [\odot].
4. Confirm selection [\ast].
The public holiday is deleted.

Note: Public holidays that are not assigned to a specific date should be deleted by the end of the year so that they are not carried on into the following year.









1.8.2 Setting vacation periods

During vacation periods, the controller constantly remains in reduced operation. A maximum of 10 vacation periods can be entered. Each vacation period can be separately assigned to the heating circuits Rk1, Rk2 and/or the DHW circuit.

Parameter	WE	Level / Range of values
Vacation period (START, STOP)	–	Extended information level / 01.01 to 31.12

Proceed as follows:



1. In the extended information level (normal switch position ) select data point for vacation periods [0].
Display: 
2. Open data point for vacation periods [*].
Display: **START**
3. If applicable, select - - - - [0].
4. Activate editing mode for start date of vacation period [*].
 and  blink.
5. Edit start date of vacation period [0].
6. Confirm start date of the vacation period.
Display: **STOP**, - - - -
7. Edit end of vacation period [0].
8. Confirm end of vacation period [*].
The black square at the top of the display indicate the assignment of the vacation periods to the individual control circuits.
9. Select the control circuit to which the current vacation period should apply [0].
 -  Current vacation period applies to heating circuit 1
 -  Current vacation period applies to heating circuit 2
 -  –
 -  Current vacation period applies to DHW circuit
 The vacation period can be assigned to a single control circuit or any combination of all three circuits (Rk1, Rk2, DHW circuit).

To enter additional vacation periods, re-select - - - - and repeat the steps 4 to 9.

Note: Vacation periods can also be set in PA5 parameter level (-> section 2.3).

Deleting vacation periods:

1. Under data point for vacation periods, select the start date of the period you wish to delete [↵].
 2. Confirm selection [↵].
 3. Select --- [↵].
 4. Confirm selection [↵].
The vacation period is deleted.
-

Note: Vacation periods should be deleted by the end of the year so that they are not carried on into the following year.

1.9 Entering day and night set points

The desired room temperature for the day (*Day set point*) and a reduced room temperature for the night (*Night set point*) can be entered in the controller for the heating circuits. In the DHW circuit, the temperature you wish the DHW to be heated to can be set.







Switch position

Parameters		WE	Range of values
Day set point	Rk1, Rk2	20 °C	0 to 40 °C
DHW temperature set point		55 °C	Min. to max. DHW temperature

Switch position

Parameters		WE	Range of values
Night set point	Rk1, Rk2	20 °C	0 to 40 °C
DHW sustained temperature		40 °C	Min. to max. DHW temperature

Proceed as follows:

- Turn the rotary switch to the required data point:
 -  for Day set point or DHW temperature set point
 -  for Night set point or DHW sustained temperature
 -  blinks.
 - ▶ In systems AnI 1.0, 1.9 and 3.5, the current set point is directly indicated. Skip the following steps 2 and 3 (selecting the control circuit).
- Select the control circuit for which the set point is to be entered []:
 - 1 Heating circuit 1
 - 2 Heating circuit 2
 - 3 DHW circuit
 - ▶ Only those control circuits are available for selection which can be controlled by the system (AnI) selected.
- Confirm the control circuit [].
Display: current set point
- Adjust set point [].
- Return the rotary switch to normal switch position  (information level).

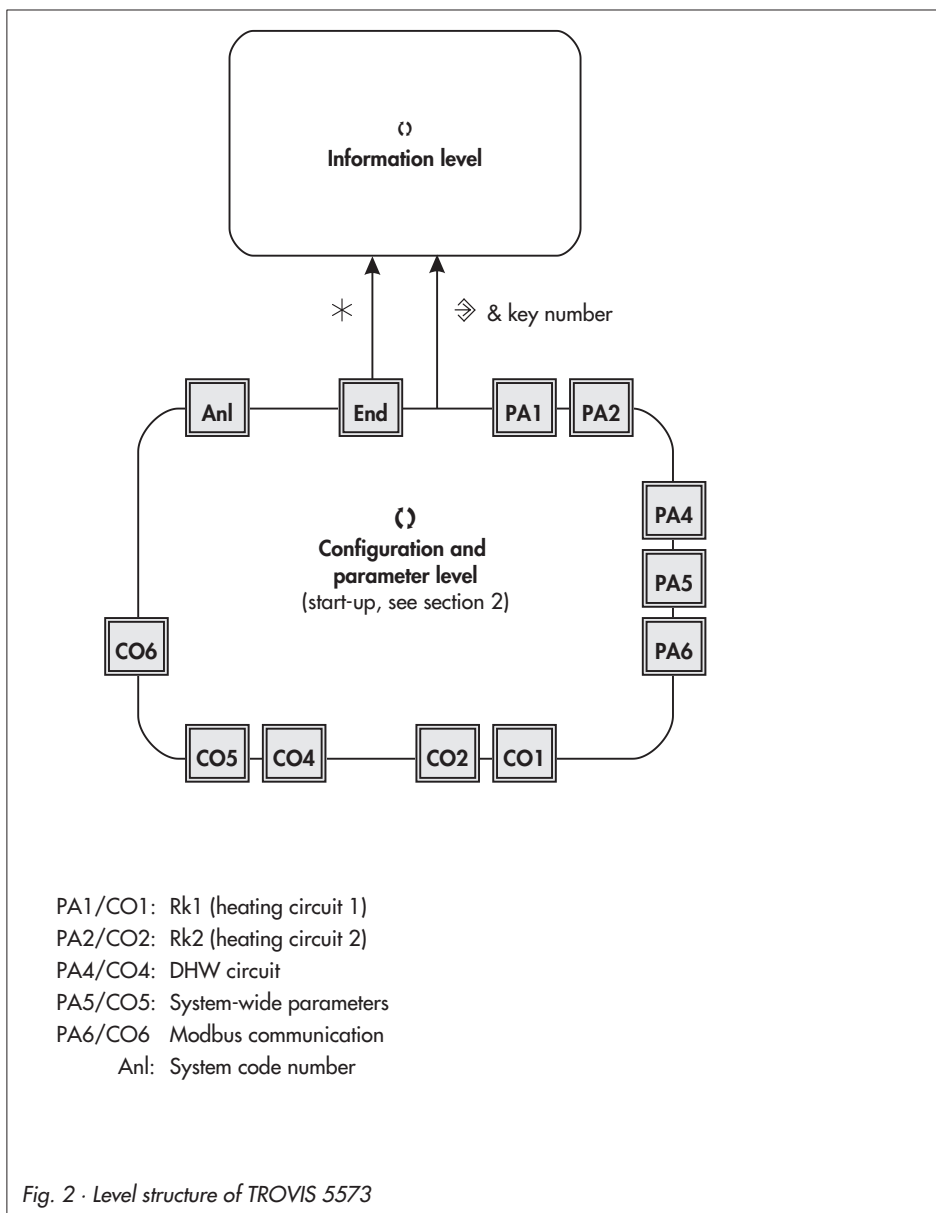

2 Start-up

The modifications of the controller configuration and parameter settings described in this section can only be performed after the valid key number has been entered.

The valid key number for initial start-up can be found on page 123. To avoid unauthorized use of the key number, remove the page or make the key number unreadable. In addition, it is possible to enter a new, customized key number (-> section 7.15).

2.1 Setting the system code number

21 different hydraulic schematics are available. Each system configuration is represented by a system code number. The different schematics are dealt with in section 4. Available controller functions are described in sections 5, 6 and 7.

Changing the system code number resets previously adjusted function blocks to their default settings (WE). Function block parameters and parameter level settings remain unchanged. The system code number is set in the configuration and parameter level.

Proceed as follows:

1. Turn the rotary switch to \diamond (configuration and parameter level).
Display: **0 0 0 0**
2. Set valid key number [\heartsuit].
3. Confirm key number [\ast].
Display: **PA_**
4. Select **Anl.**
5. Activate editing mode for the system code number [\ast].
 \blacktriangleleft blinks.
6. Edit system code number [\heartsuit].
7. Confirm system code number [\ast].
Display: **End**
8. Return the rotary switch to normal switch position \square (information level).

2.2 Activating and deactivating functions

A function is activated or deactivated in the associated function block. The numbers 0 to 24 in the top row of the display represent the respective function block numbers. When a configuration level is opened, the activated function blocks are indicated by a black square on the right-hand side below the function block number. For more details on function blocks, refer to section 12.1.

The functions are grouped by topics:

- ▶ CO1: Rk1 (Heating circuit 1)
- ▶ CO2: Rk2 (Heating circuit 2)
- ▶ CO3: Not applicable
- ▶ CO4: DHW circuit
- ▶ CO5: System-wide functions
- ▶ CO6: Modbus communication

1. Turn the rotary switch to \diamond (configuration and parameter level).

Display: **0000**

2. Set valid key number [\diamond].

3. Confirm key number [*].

Display: **PA_**

4. Select configuration level [\diamond].

5. Open configuration level [*].

6. Select function block [\diamond].

Activated function blocks are marked by “- 1”.

Deactivated function blocks are marked by “- 0”.

7. Activate editing mode for the function block [*].

▬ blinks.

8. Activate the function block [\diamond].

Display: **F_ - 1**

An activated function block is indicated by a black square below (right) the function block number in the top row of the controller display.

or:

Deactivate the function block [\diamond].

Display: **F_ - 0**

10. Confirm settings [✱].

If the function block is not closed, further function block parameters can be adjusted.
Proceed as follows:

- a) Select function block parameter [↵].
- b) Confirm function block parameter [✱].
If applicable, the next function block parameter is displayed.
Confirm all parameters to exit the opened function block.

To adjust additional function blocks in the open configuration level, repeat the steps 6 to 10.

11. Select *End* [↵].**12. Exit configuration level [✱].**

To adjust additional function blocks in the other configuration levels, repeat 4 to 10.











13. Return the rotary switch to normal switch position  (information level).

2.3 Changing parameters



Depending on the set system code number and the activated functions, not all parameters listed in the parameter list in the Appendix (→ section 12.2) might be available.

The parameters are grouped by topics:

- ▶ PA1: Rk1 (Heating circuit 1)
- ▶ PA2: Rk2 (Heating circuit 2)
- ▶ PA3: Not applicable
- ▶ PA4: DHW heating
- ▶ PA5: System-wide parameters
- ▶ PA6: Communication parameters

1. Turn the rotary switch to  (configuration and parameter level).
Display: **0000**
2. Set valid key number [].
3. Confirm key number [].
Display: **PA_**
4. Select parameter level [].
5. Open parameter level [].
6. Select parameter [].
7. Activate editing mode for the parameter [].
  blinks.
8. Edit the parameter [].
9. Confirm the parameter [].

To adjust additional parameters in the open parameter level, repeat steps 6 to 9.

10. Select **End** [].
11. Exit parameter level [].

To adjust additional parameters in another parameter level, repeat steps 4 to 9.

12. Return the rotary switch to normal switch position  (information level).

2.4 Calibrating sensors

The controller is designed for the connection of Pt 1000 sensors.
The resistance values of the Pt 1000 sensors can be found on page 112.

If the temperature values displayed at the controller differ from the actual temperatures, the measured values of all connected sensors can be readjusted. To calibrate a sensor, the currently displayed sensor value must be changed such that it matches the temperature (reference temperature) measured directly at the point of measurement.

Sensor calibration is to be activated in CO5 via function block F20.
An incorrect sensor calibration can be deleted by setting F20 - 0.

Proceed as follows:

1. Turn the rotary switch to \diamond (configuration and parameter level).
Display: **0 0 0 0**
2. Set valid key number [\heartsuit].
3. Confirm valid key number [\ast].
Display: **PA_**
4. Select CO5 configuration level [\heartsuit].
5. Open CO5 configuration level [\ast].
6. Select function block F20 [\heartsuit].
7. Activate editing mode for function block F20 [\ast].
8. Select appropriate sensor icon [\heartsuit]:



Room sensor RF, heating circuits 1 and 2



Outdoor sensor AF1



Flow sensor VF, heating circuits 1 and 2



Flow sensor VF1, primary heat exchanger circuit







Flow sensors VF2 and VF4, DHW circuit



Solar collector sensor VF3



Return flow sensor RüF

-  Storage tank sensor SF1
 -  Storage tank sensor SF2
 -  Storage tank sensor of the solar circuit SF2
9. Display measured value [✖].
"°C" blinks.
 10. Correct measured value [↻].
Read the actual temperature directly from the thermometer at the point of measurement and enter this value as the reference temperature.
 11. Confirm corrected measured value [✖].
Additional sensors are calibrated similarly.
 12. Select **End** [↻].
 13. Return the rotary switch to normal switch position  (information level).

2.5 Resetting to default values

All parameters set over the rotary switch as well as parameters in PA1, PA2 and PA5 parameter levels can be reset to their default settings (WE), except for the maximum flow temperature and the return flow temperature limits in PA1 and PA2.

1. Turn the rotary switch to  (configuration and parameter level).
Display: **0000**
2. Set key number 1991 [↻].
3. Confirm key number [✖].
The controller is reset to its default settings.
Display: **0000**







3 Manual mode

Switch to manual mode to configure all outputs, refer to wiring diagram (-> section 11).

NOTICE

The frost protection does not function when the controller is in manual mode.

Proceed as follows:

1. Turn the rotary switch to  (manual level).
 2. Select output depending on the control circuit ():
 - POS_ Positioning value in percent
 - UP_ Activation/deactivation of the circulation pump (heating)
 - SLP Activation/deactivation of the storage tank charging pump
 - TLP Activation/deactivation of the heat exchanger charging pump
 - CP Activation/deactivation of the solar circuit pump
 - ZP Activation/deactivation of the circulation pump (DHW)
 3. Confirm the output [].
The display blinks.
 4. Change positioning value/switching state [].
 5. Confirm setting [].
The modified values remain active as long as the controller is in manual mode.
 6. Return the rotary switch to normal switch position  (information level).
The manual mode is deactivated.
-

Note: *The outputs of the controller are not affected by simply turning the rotary switch to  (manual level). You have to actually enter a positioning value or activate/deactivate the pumps to configure the outputs.*

4 Systems

21 different hydraulic schematics are available.

The systems can be configured both as primary and secondary systems. The fundamental hydraulic differences between a primary and a secondary system are illustrated in Fig. 3.

- ▶ 1. mixing valve replaces the heat exchanger in the heating/DHW circuit.
- ▶ 2. A storage tank charging pump replaces the primary solenoid/thermoelectric valve.

The controller settings do not have to be changed.

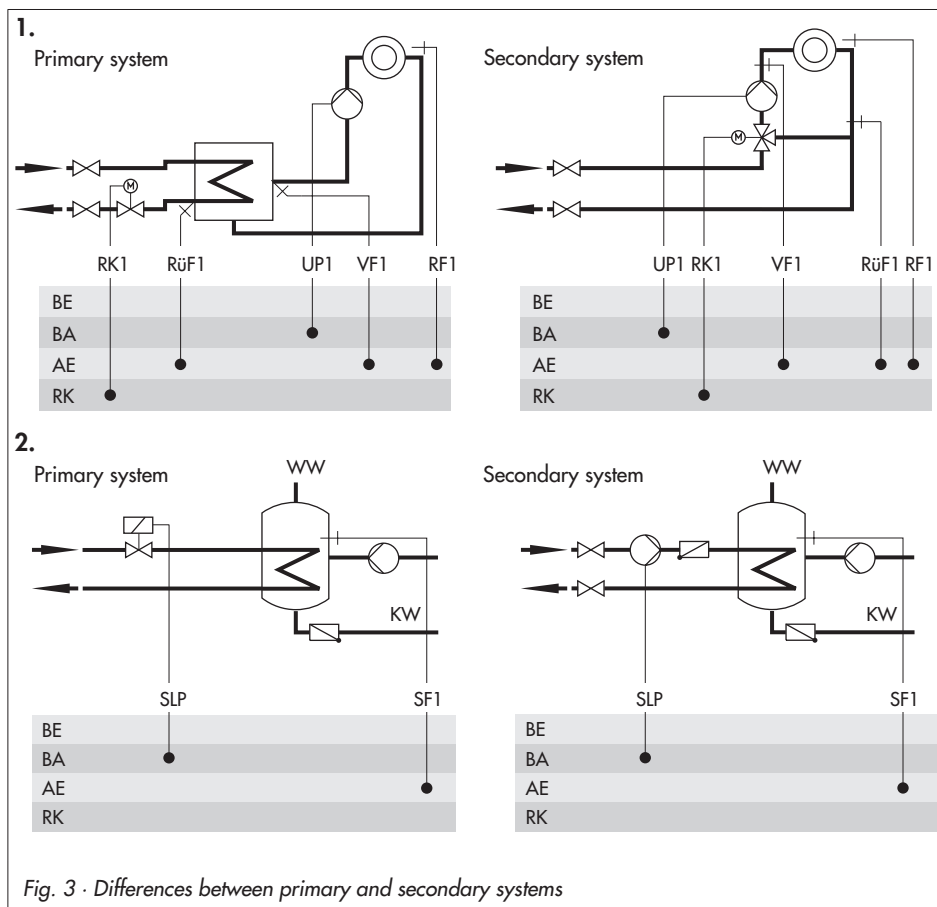

Boiler systems:

Single-stage boiler systems can be configured to include any system whose heating circuits and DHW circuit include just one heat exchanger. These systems are Anl 1.0, 1.5, 1.6, 2.x, 3.0, 3.5, 4.0 and 4.1.

The boiler can be controlled by an on/off output (CO1 -> F12 - 0).

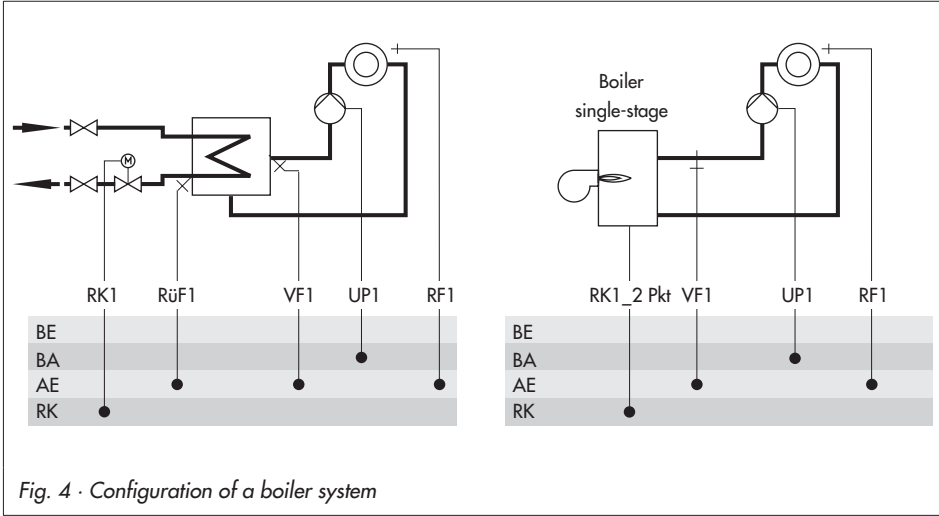

System Anl 1.0

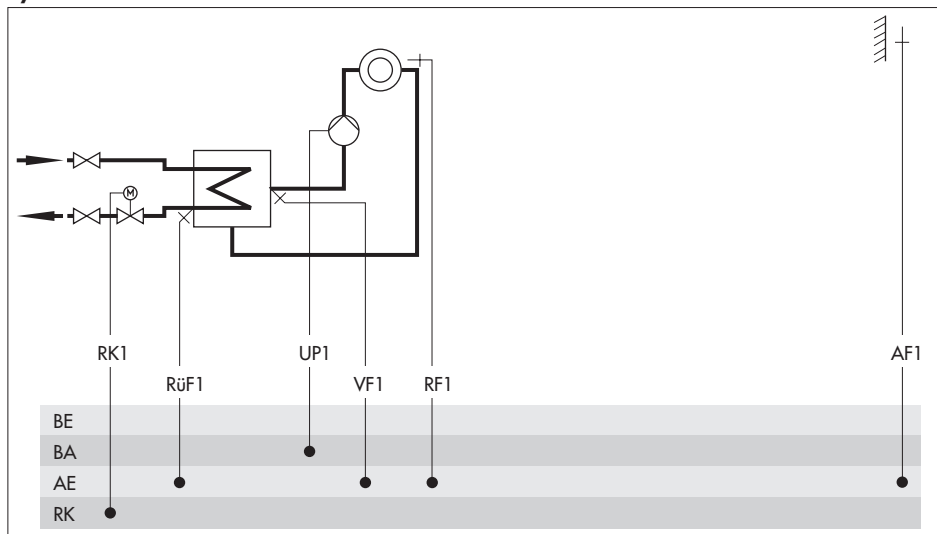

Default settings

CO1 -> F01	- 0 (without RF1)
CO1 -> F02	- 1 (with AF1)
CO1 -> F03	- 1 (with RüF1)

Systems Anl 1.1 to 1.3

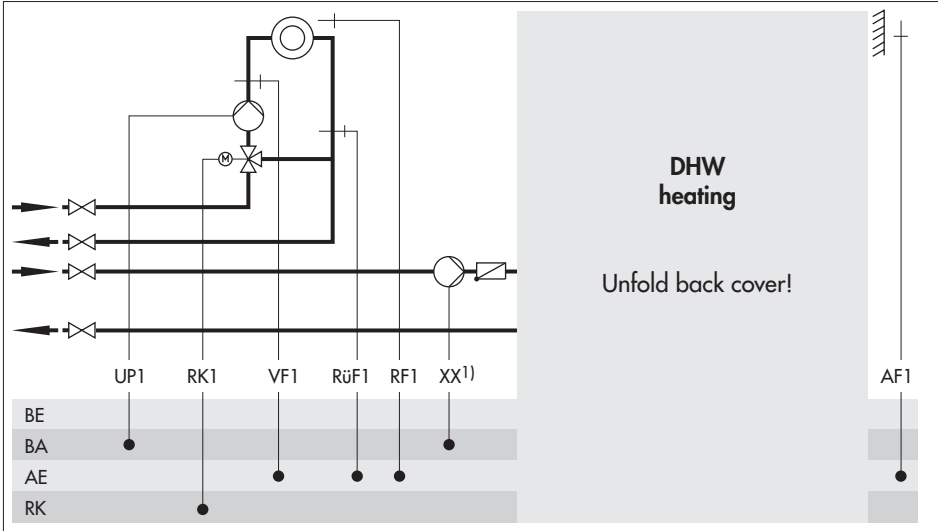

System	Anl 1.1	Anl 1.2	Anl 1.3
Type of DHW heating	Type 1	Type 2	Type 3
¹⁾ XX =	SLP	TLP	SLP
Integration of flow sensor VF4	Possible	Possible	-
ZP integration with CO4 -> F10 - 1 (broken line)	-	Not possible	-
Note	-	Secondary system only	-
Default settings			
CO1 -> F01	- 0 (without RF1)	- 0 (without RF1)	- 0 (without RF1)
CO1 -> F02	- 1 (with AF1)	- 1 (with AF1)	- 1 (with AF1)
CO1 -> F03	- 1 (with RüF1)	- 0 (without RüF1)	- 1 (with RüF1)
CO4 -> F01	- 1 (with SF1)	- 1 (with SF1)	- 1 (with SF1)
CO4 -> F02	- 0 (without SF2)	- 1 (with SF2)	- 0 (without SF2)
CO4 -> F05	- 0 (without VF4)	- 0 (without VF4)	- 0 (without VF4)

System Anl 1.5

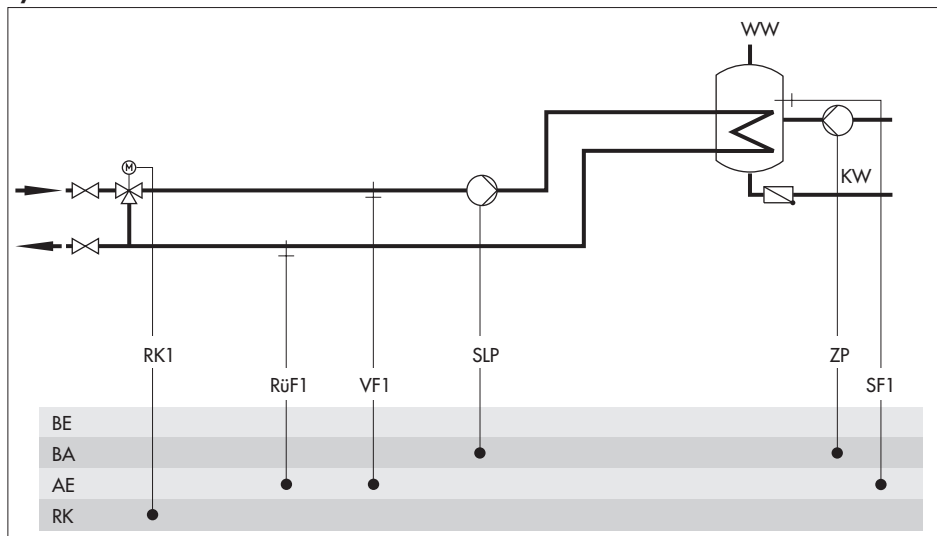

Default settings

CO1 -> F03	- 1 (with RüF1)
CO4 -> F01	- 1 (with SF1)
CO4 -> F02	- 0 (without SF2)

System Anl 1.6

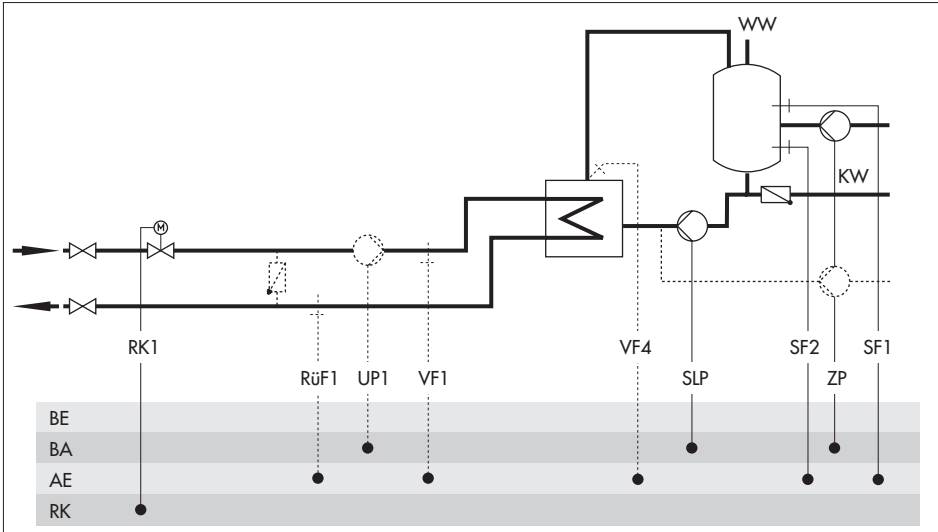

System	Anl 1.6 with pre-control	Anl 1.6 without pre-control
Integration of VF4, UP1	Possible	Not possible
ZP integration with CO4 -> F10 - 1 (broken line)	Possible	Possible
Note	-	VF1 takes the position of VF4; RüF1 is to be installed in the heat exchanger
Default settings		
CO1 -> F03	- 1 (with RüF1)	
CO4 -> F01	- 1 (with SF1)	
CO4 -> F02	- 1 (with SF2)	
CO4 -> F05	- 0 (without VF4)	

System Anl 1.9

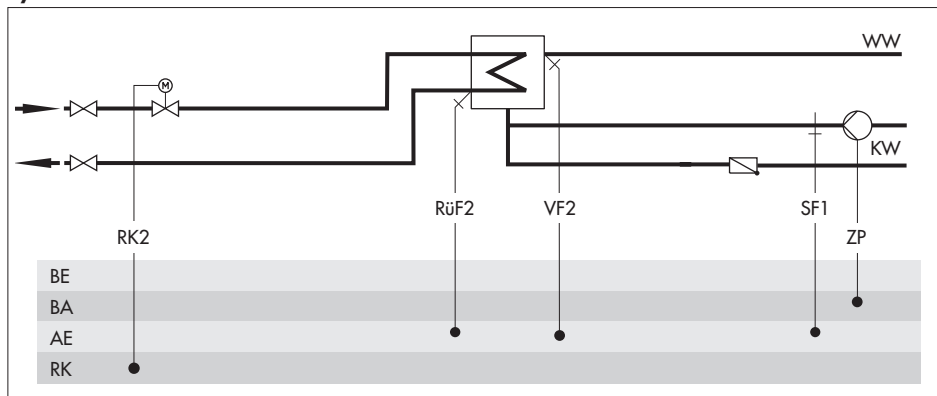

Default settings

CO4 -> F01	- 0 (without SF1)
CO4 -> F03	- 0 (without RüF2)

System Anl 2.0

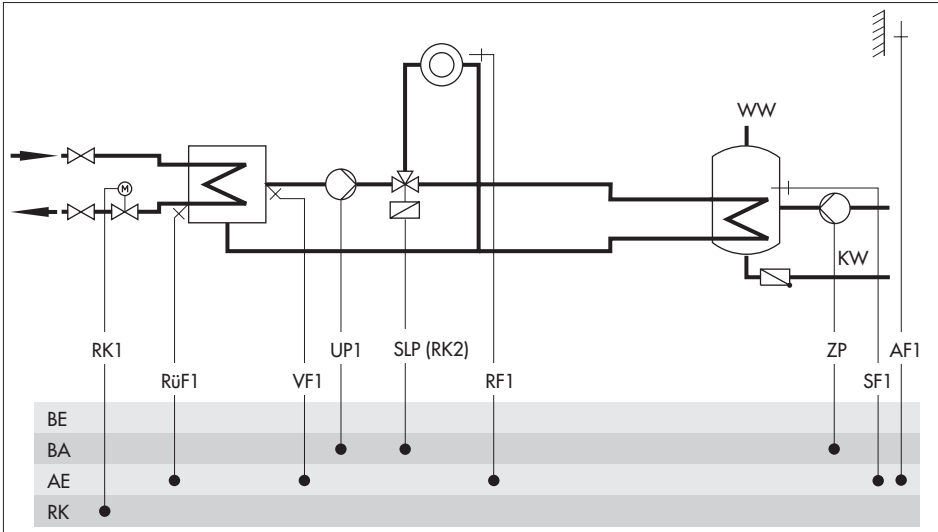

Default settings

CO1 -> F01	- 0 (without RF1)
CO1 -> F02	- 1 (with AF1)
CO1 -> F03	- 1 (with RüF1)
CO4 -> F01	- 1 (with SF1)
CO4 -> F02	- 0 (without SF2)

Systems Anl 2.1 to 2.3

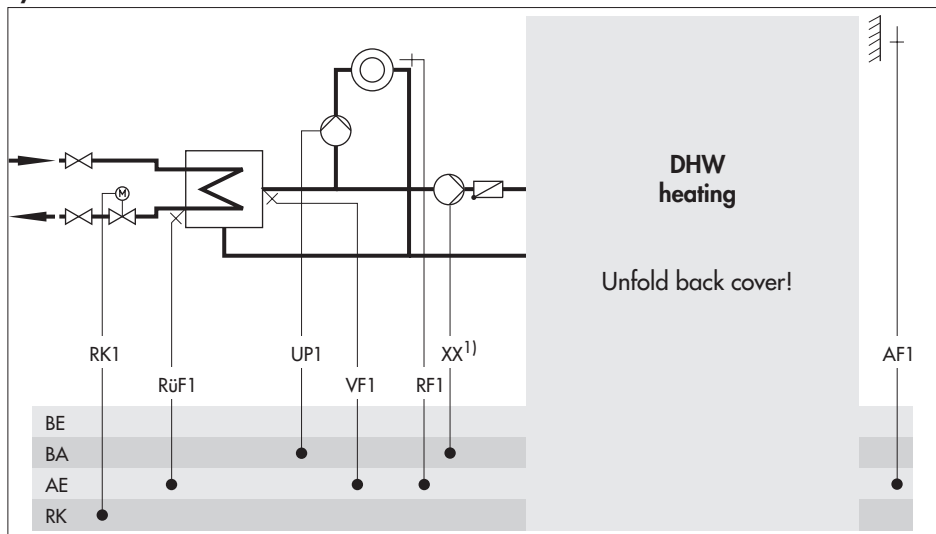

System	Anl 2.1	Anl 2.2	Anl 2.3
Type of DHW heating	Type 1	Type 2	Type 3
¹⁾ XX =	SLP	TLP	SLP
Integration of VF4	Not possible	Possible	-
ZP integration with CO4 -> F10 - 1 (broken line)	-	Not possible	-
Default settings			
CO1 -> F01	- 0 (without RF1)	- 0 (without RF1)	- 0 (without RF1)
CO1 -> F02	- 1 (with AF1)	- 1 (with AF1)	- 1 (with AF1)
CO1 -> F03	- 1 (with RUF1)	- 1 (with RUF1)	- 1 (with RUF1)
CO4 -> F01	- 1 (with SF1)	- 1 (with SF1)	- 1 (with SF1)
CO4 -> F02	- 0 (without SF2)	- 1 (with SF2)	
CO4 -> F05		- 0 (without VF4)	

System Anl 3.0

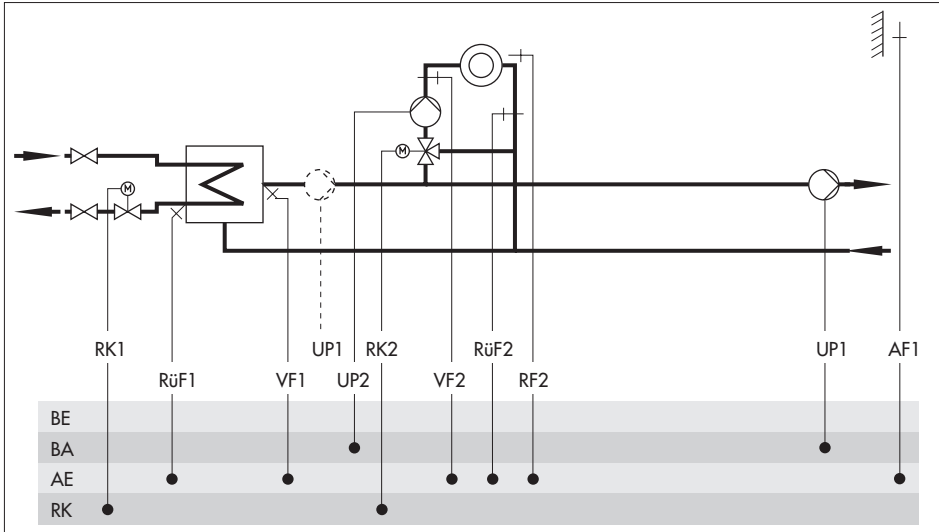

Default settings

CO1 -> F02	- 1 (with AF1)
CO1 -> F03	- 1 (with RüF1)
CO2 -> F01	- 0 (without RF2)
CO2 -> F03	- 0 (without RüF2)

System Anl 3.5

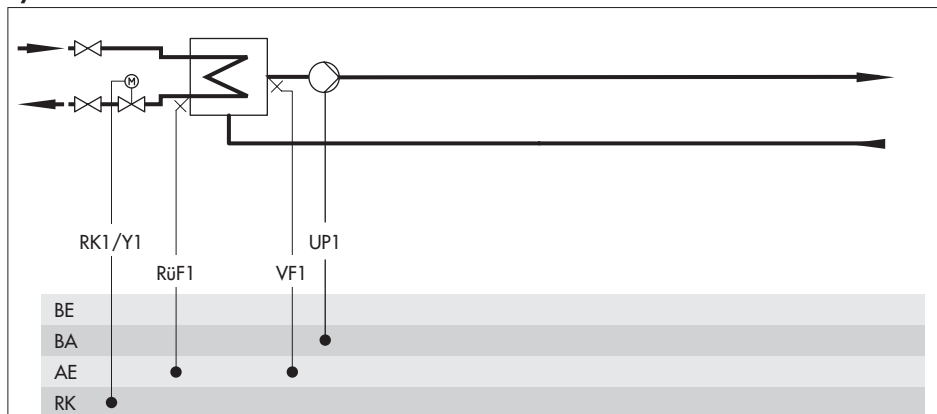

Note

Closed control loop and UP1 are only active during the processing for an external demand

Default settings

CO1 -> F03

- 1 (with RüF1)

System Anl 4.0

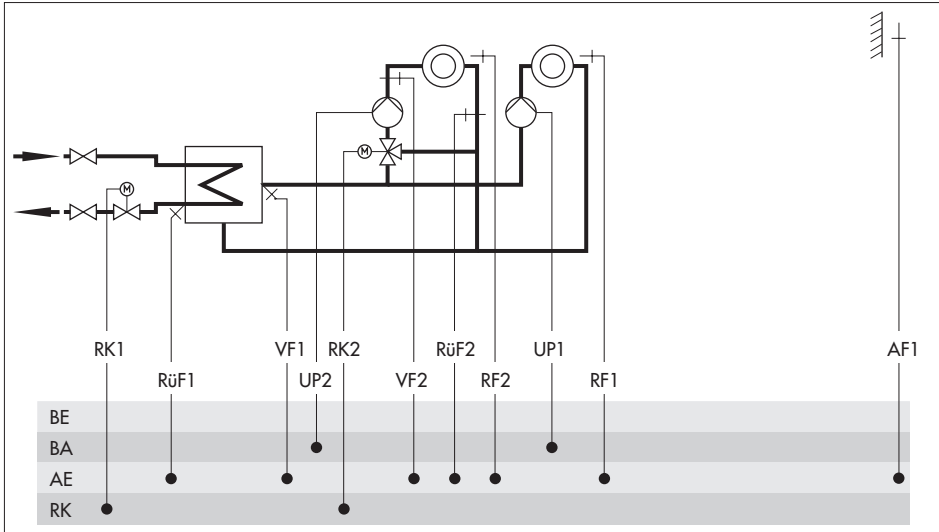

Default settings

CO1 -> F01	- 0 (without RF1)
CO1 -> F02	- 1 (with AF1)
CO1 -> F03	- 1 (with RüF1)
CO2 -> F01	- 0 (without RF2)
CO2 -> F03	- 0 (without RüF2)

System Anl 4.1

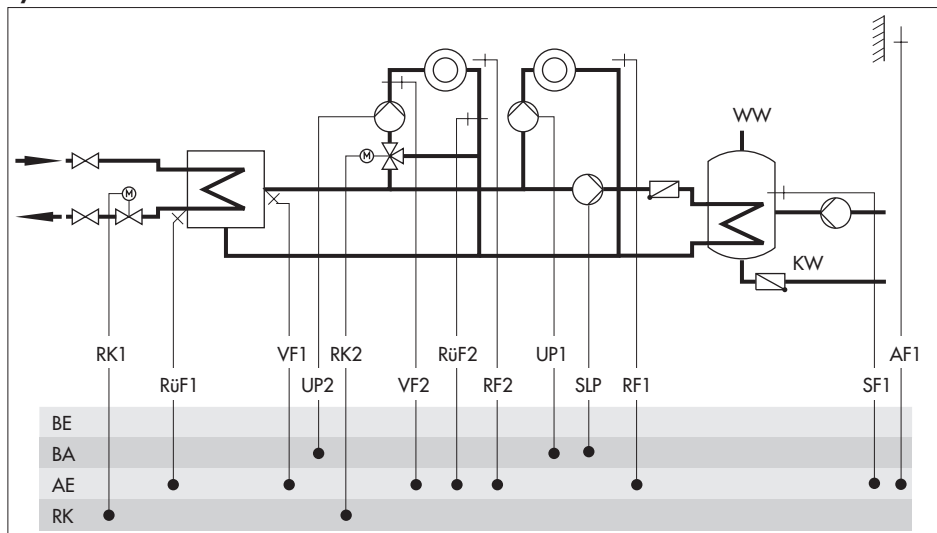

Default settings

CO1 -> F01	- 0 (without RF1)
CO1 -> F02	- 1 (with AF1)
CO1 -> F03	- 1 (with RüF1)
CO2 -> F01	- 0 (without RF2)
CO2 -> F03	- 0 (without RüF2)
CO4 -> F01	- 1 (with SF1)
CO4 -> F02	- 0 (without SF2)

System Anl 4.5

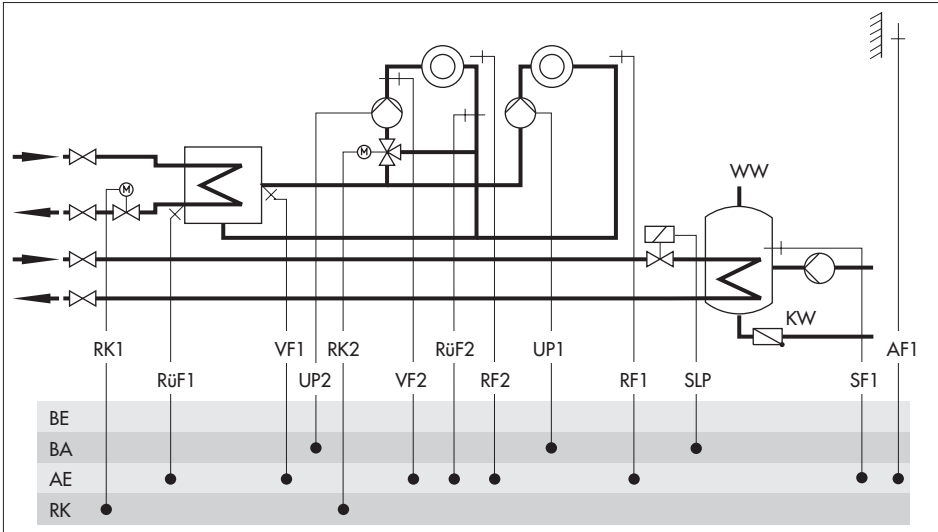

Default settings

CO1 -> F01	- 0 (without RF1)
CO1 -> F02	- 1 (with AF1)
CO1 -> F03	- 1 (with RüF1)
CO2 -> F01	- 0 (without RF2)
CO2 -> F03	- 0 (without RüF2)
CO4 -> F01	- 1 (with SF1)
CO4 -> F02	- 0 (without SF2)

System Anl 10.0

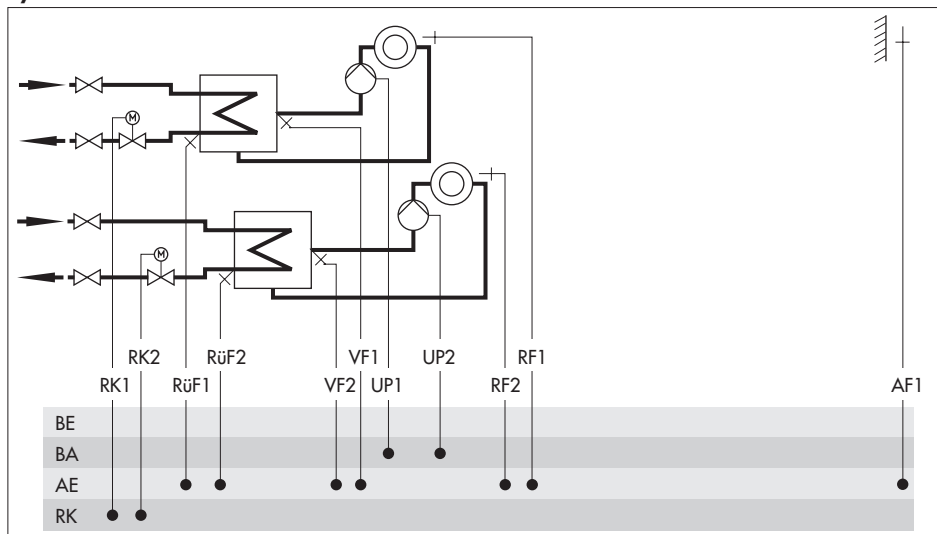

Default settings

CO1 -> F01	- 0 (without RF1)
CO1 -> F02	- 1 (with AF1)
CO1 -> F03	- 1 (with RüF1)
CO2 -> F01	- 0 (without RF2)
CO2 -> F03	- 1 (with RüF2)

System Anl 11.0

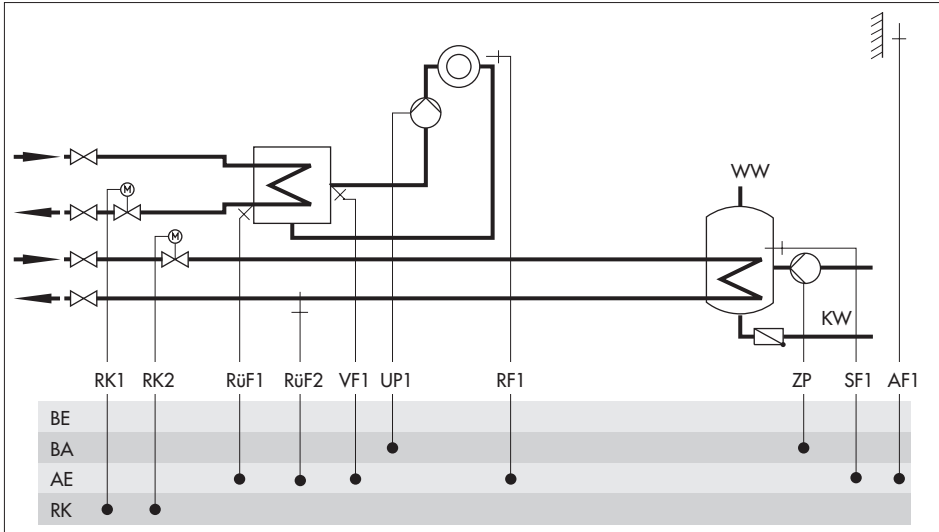

Default settings

CO1 -> F01	- 0 (without RF1)
CO1 -> F02	- 1 (with AF1)
CO1 -> F03	- 1 (with RüF1)
CO4 -> F03	- 0 (without RüF2)

System Anl 11.1

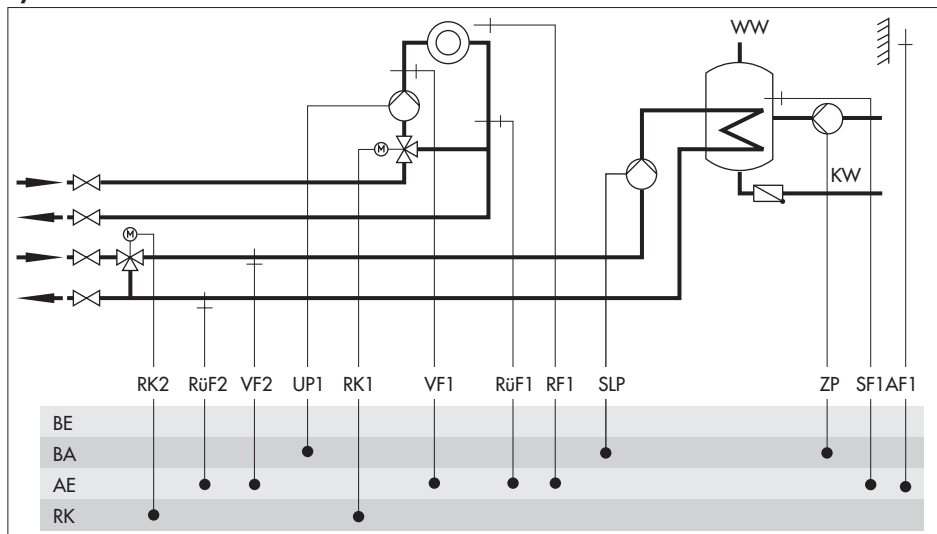

Default settings

CO1 -> F01	- 0 (without RF1)
CO1 -> F02	- 1 (with AF1)
CO1 -> F03	- 1 (with RüF1)
CO4 -> F01	- 1 (with SF1)
CO4 -> F02	- 0 (without SF2)
CO4 -> F03	- 0 (without RüF2)

System Anl 11.2

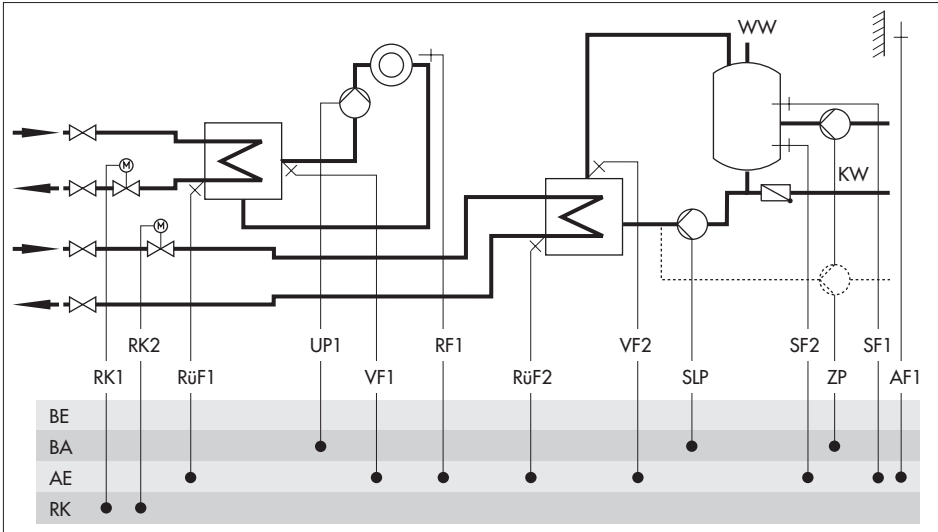

Default settings

CO1 -> F01	- 0 (without RF1)
CO1 -> F02	- 1 (with AF1)
CO1 -> F03	- 1 (with RüF1)
CO4 -> F01	- 1 (with SF1)
CO4 -> F02	- 1 (with SF2)
CO4 -> F03	- 0 (without RüF2)

System Anl 11.9

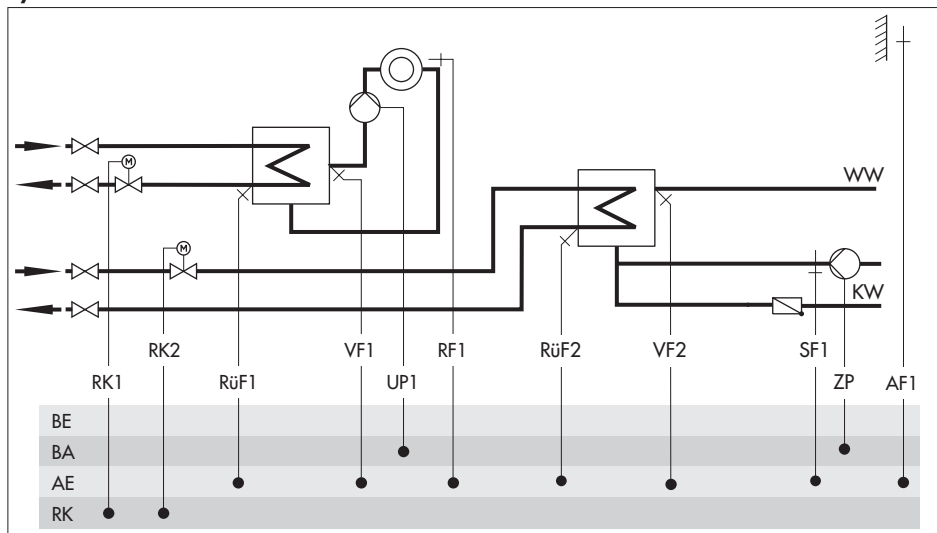

Default settings

CO1 -> F01	- 0 (without RF1)
CO1 -> F02	- 1 (with AF1)
CO1 -> F03	- 1 (with RüF1)
CO4 -> F01	- 0 (without SF1)
CO4 -> F03	- 0 (without RüF2)

5 Functions of the heating circuit

Which controller functions are available depends on the selected system code number (AnI).

5.1 Weather-compensated control

When weather-compensated control is used, the flow temperature is controlled according to the outdoor temperature. The heating characteristic in the controller defines the flow temperature set point as a function of the outdoor temperature (→ Fig. 5). The outdoor temperature required for weather-compensated control can either be measured by an outdoor sensor or it can be received over an 0 to 10 V input.

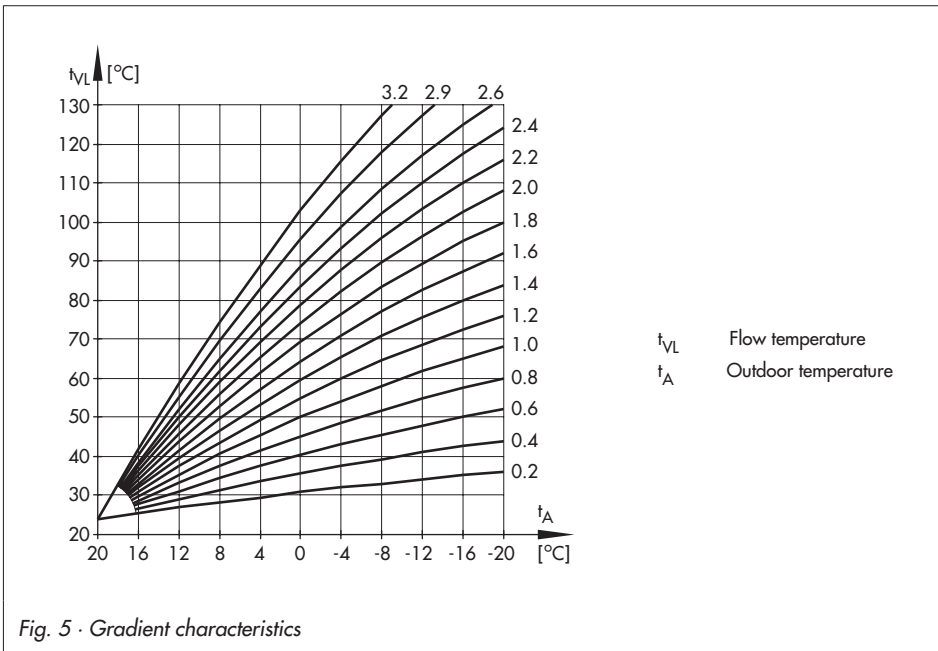

Fig. 5 · Gradient characteristics

Function	WE	Configuration
Outdoor sensor AF1	1	CO1 -> F02 - 1
Outdoor temperature received over 0 to 10 V input	0	CO5 -> F23 - 1
	-20 °C	Lower transmission range / -30 to 100 °C
	50 °C	Upper transmission range / -30 to 100 °C

5.1.1 Gradient characteristic

Basically, the following rule applies: a decrease in the outdoor temperature causes the flow temperature to increase in order to keep the room temperature constant.

By varying the parameters *Gradient* and *Level*, you can adapt the characteristic to your individual requirements:

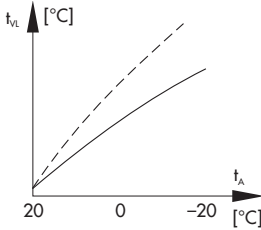

The gradient needs to be increased **if the room temperature drops when it is cold outside.**

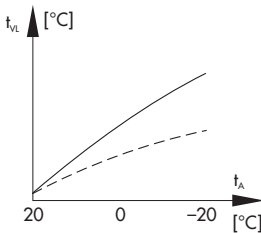

The gradient needs to be decreased **if the room temperature rises when it is cold outside.**

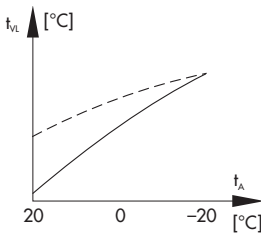

The level needs to be increased and the gradient decreased **if the room temperature drops when it is mild outside.**

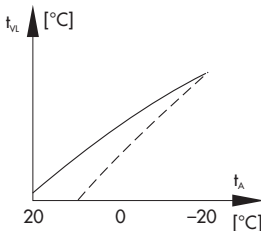

The level needs to be decreased and the gradient increased **if the room temperature rises when it is mild outside.**

Outside the times-of-use, reduced set points are used for control:

The reduced flow set point is calculated as the difference between the adjusted values for *Day set point* (rated room temperature) and *Night set point* (reduced room temperature).

The *Max. flow temperature* and *Min. flow temperature* parameters mark the upper and lower limits of the flow temperature. A separate gradient characteristic can be selected for the limitation of the return flow temperature.

Examples for adjusting the characteristic:

- ▶ Old building, radiator design 90/70: Gradient approx. 1.8
- ▶ New building, radiator design 70/55: Gradient approx. 1.4
- ▶ New building, radiator design 55/45: Gradient approx. 1.0
- ▶ Underfloor heating depending on arrangement: Gradient smaller than 0.5

Note: Particularly for control operation without room sensor, the room temperatures set for day (*Day set point*) and night (*Night set point*) only become effective satisfactorily when the heating characteristic has been adapted to the building/heating surface layout.

Function	WE	Configuration
4-point characteristic	0	CO1, 2 -> F11 - 0
Parameters	WE	Switch position / Range of values
Day set point	20.0 °C	↓☀ / 0.0 to 40.0 °C
Night set point	15.0 °C	↓☾ / 0.0 to 40.0 °C
Parameters	WE	Parameter level / Range of values
Gradient, flow	1.8*	PA1, 2 / 0.2 to 3.2
Level, flow	0.0 °C	PA1, 2 / -30.0 to 30.0 °C
Min. flow temperature	20.0 °C	PA1, 2 / 5.0 to 130.0 °C
Max. flow temperature	90.0 °C*	PA1, 2 / 5.0 to 130.0 °C
* With CO1, 2 -> F05 - 1, the following applies: Gradient, flow / 0.2 to 1.0 (1.0) Max. flow temperature / 5.0 to 50.0 °C (50.0 °C)		

5.1.2 4-point characteristic

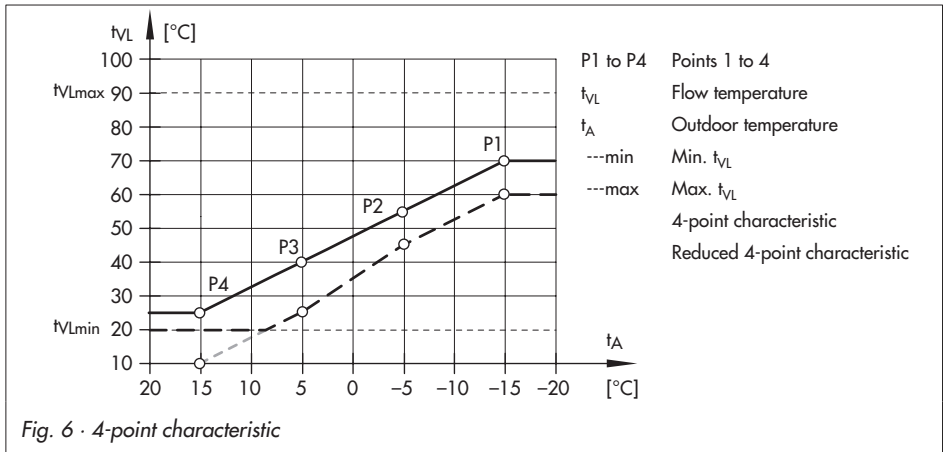

Fig. 6 · 4-point characteristic

The 4-point characteristic allows you to define your own heating characteristic. It is defined by 4 points for the *Outdoor temperature*, the *Flow temperature*, the *Reduced flow temperature* and the *Return flow temperature*. The *Max. flow temperature* and *Min. flow temperature* parameters mark the upper and lower limits of the flow temperature.

Note:

The Day set point and Night set point parameters are no longer available when the 4-point characteristic has been selected, provided no additional functions (e.g. **Optimization**, **Flash adaptation**) have been selected.

The **4-point characteristic** function can only be activated when the **Adaptation** function is not active (CO1, 2 -> F08 - 0).

Functions		WE	Configuration
Adaptation		0	CO1, 2 -> F08 - 0
4-point characteristic		0	CO1, 2 -> F11 - 1
Parameters		WE	Parameter level / Range of values
Outdoor temperature	Point 1	-15.0 °C	PA1, 2 / -40.0 to 50.0 °C
	Point 2	-5.0 °C	
	Point 3	5.0 °C	
	Point 4	15.0 °C	

Parameters		WE	Parameter level / Range of values
Flow temperature	Point 1	70.0 °C	PA1, 2 / 5.0 to 130.0 °C
	Point 2	55.0 °C	
	Point 3	40.0 °C	
	Point 4	25.0 °C	
Reduced flow temperature	Point 1	60.0 °C	PA1, 2 / 5.0 to 130.0 °C
	Point 2	40.0 °C	
	Point 3	20.0 °C	
	Point 4	20.0 °C	
Return flow temperature	Points 1 to 4	65.0 °C	PA1, 2 / 5.0 to 90.0 °C
Min. flow temperature		20.0 °C	PA1, 2 / 5.0 to 130.0 °C
Max. flow temperature		90.0 °C*	PA1, 2 / 5.0 to 130.0 °C

* With CO1, 2 -> F05 - 1, the following applies: Max. flow temperature / 5 to 50 °C (50 °C)

5.2 Fixed set point control

During the times-of-use, the flow temperature can be controlled according to a fixed set point. Outside the times-of-use, the controller regulates to a reduced flow temperature. Set the desired rated flow temperature as *Day set point*, and the reduced flow temperature as *Night set point*.

Functions	WE	Configuration
Outdoor sensor AF1	1	CO1 -> F02 - 0

Parameters	WE	Switch position / Range of values
Day set point	50.0 °C	☀ / Min. to max. flow temperature
Night set point	30.0 °C	☾ / Min. to max. flow temperature

Parameters	WE	Parameter level / Range of values
Min. flow temperature	20.0 °C	PA1, 2 / 5.0 to 130.0 °C
Max. flow temperature	90.0 °C	PA1, 2 / 5.0 to 130.0 °C

Note: A fixed set point control in heating circuit 2 can only be configured with CO2 -> F02 - 0 if CO1 -> F02 - 0 is also configured as heating circuit 2 configured with CO2 -> F02 - 0 only uses the measured outdoor temperature provided by heating circuit 1.

5.3 Underfloor heating/drying of jointless floors

Using function block setting CO1, 2 -> F05 - 1, the respective heating circuit is configured as an underfloor heating circuit. In doing so, the controller at first only limits the value ranges of the heating characteristic gradient and the maximum flow temperature in PA1, 2 parameter levels:

- ▶ Value range of the gradient: 0.2 to 1.0
- ▶ Value range of the maximum flow temperature: 5 to 50 °C

In addition, it is possible to activate the **Drying of jointless floors** function. In connection with this, the function block parameters are listed which appear after activating this function block. They determine the drying process: the first heating up phase starts at the entered *Start temperature*, which has a flow temperature of 25 °C in its default setting. In the course of 24 hours, this temperature is raised by the value entered in *Temperature rise*, i.e. the default setting causes the flow temperature set point to rise to 30 °C. If the *Maximum temperature* is reached, it is kept constant for the number of days entered in *Maintaining time for maximum temperature*. The *Temperature reduction* determines the temperature reduction downwards. If the *Temperature reduction* is set to 0, the temperature maintaining phase moves directly to automatic mode.

The drying function is activated by changing the setting STOP to *START temperature build-up phase* (■ **STArT** on the display). The restarting stages *START temperature maintaining phase* (■■ **STArT** on the display) and *START temperature reduction phase* (■■■ **STArT** on the display) can be selected to continue an interrupted drying process. The course of the drying process can be monitored in the information level over the icon of flow temperature display (°) of the associated heating circuit:

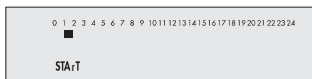

Temperature build-up phase



Temperature maintaining phase

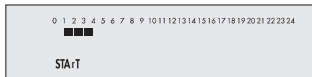

Temperature reduction phase

The drying process has been successfully completed when the additional icon in the flow temperature display goes out after the last phase.

STOP on the display indicates that there has been a deviation of flow temperature of more than 5 °C for longer than 30 minutes. The function is canceled by the controller in such cases. While STOP appears on the display, the controller keeps the flow temperature constant at 25 °C.

A power failure while the drying function is active or when *STOP* appears on the display automatically leads to the drying function restarting from the beginning.

In systems in which the drying function had to be interrupted due to DHW heating (e.g. Anl 2.1), storage tank charging does not occur while the drying function is active, provided it is not used for frost protection of the storage tank.

NOTICE

The function block parameter can only be accessed when the function has started by deactivating the function block and activating it again.

Functions	WE	Configuration
Underfloor heating	0	CO1, 2 -> F05 - 1
Drying of jointless floors	25 °C	Start temperature / 20 to 60 °C
	5.0 °C	Temperature rise per day / 1.0 to 10.0 °C
	45.0 °C	Maximum temperature / 25.0 to 60.0 °C
	4	Maintaining time for max. temperature / 0 to 10 days
	0.0 °C	Temperature reduction per day / 0.0 to 10.0 °C
SToP	■ STArT, ■■ STArT, ■■■ STArT	

5.4 Deactivation depending on outdoor temperature

5.4.1 OT deactivation value in rated operation

If the outdoor temperature exceeds the limit *OT deactivation value in rated operation*, the affected heating circuit is put out of service immediately. The valve is closed and the pump is switched off after $t = 2 \times$ valve transit time. When the outdoor temperature falls below this value (less 0.5 °C hysteresis), heating operation is restarted immediately.

With the default settings, this means that, during the warm season, the system is switched off at an outdoor temperature of 22 °C.

Parameter	WE	Parameter level / Range of values
OT deactivation value in rated operation	22.0 °C	PA1, 2 / 0.0 to 50.0 °C

5.4.2 OT deactivation value in reduced operation

If the outdoor temperature exceeds the limit value *OT deactivation value in reduced operation* in reduced operation, the affected heating circuit is put out of service immediately.

The valve is closed and the pump is switched off after $t = 2 \times$ valve transit time. When the outdoor temperature falls below this value (less 0.5 °C hysteresis), heating operation is restarted immediately.

With the default settings, this means that, at night, the system is switched off at an outdoor temperature of 15 °C to save energy. Nevertheless, remember that the system requires some time in the morning to heat up the building.

Parameter	WE	Parameter level / Range of values
OT deactivation value in reduced operation	15.0 °C	PA1, 2 / -20.0 to 50.0 °C

5.4.3 OT activation value in rated operation

If a heating circuit is in reduced operation (automatic mode), the circuit is automatically transferred to rated operation when the outdoor temperature falls below the limit value *OT activation value in rated operation*. When the limit value is exceeded (plus 0.5 °C hysteresis), reduced operation is restarted.

This function is activated at very low temperatures to avoid that the building cools down excessively outside the times-of-use when low outdoor temperatures occur.

Parameter	WE	Parameter level / Range of values
OT activation value in rated operation	-15.0 °C	PA1, 2 / -20.0 to 5.0 °C

5.4.4 Summer mode

Summer mode is activated depending on the mean daytime temperature (measured between 7.00h and 22.00h) during the desired period.

If the mean daytime temperature exceeds the *OT limit value in summer mode* on n successive days, summer mode is activated on the following day. This means that the valves in all heating circuits are closed and the circulation pumps are switched off after $t = 2 \times$ valve transit time. If the mean daytime temperature remains below the *OT limit value in summer mode* on m successive days, summer mode is deactivated on the following day.

Function	WE	Configuration
Summer mode	0	CO5 -> F04 - 1
	01.06	Start summer mode / 01.01 (1 Jan) to 31.12 (31 Dec)
	2	No. of days until activation / 1 to 3
	30.09	Stop summer mode / 01.01 to 31.12
	1	No. of days until deactivation / 1 to 3
	18.0 °C	OT limit value summer mode / 0 to 30 °C

Note: Summer mode only becomes effective when the controller is in automatic mode (☺).

5.5 Delayed outdoor temperature adaptation

The calculated outdoor temperature is used to determine the flow temperature set point. The heat response is delayed when the outdoor temperature either decreases, increases or increases and decreases. If the outdoor temperature varies by, for example, 12 °C within a very short period of time, the calculated outdoor temperature is adapted to the actual outdoor temperature in small steps. Assuming a Delay of 3 °C/h, the adaptation would take $t = \frac{12^{\circ}\text{C}}{3^{\circ}\text{C/h}} = 4\text{h}$.

Note:

The delayed outdoor temperature adaptation helps avoid unnecessary overloads of central heating stations in combination with either overheated buildings occurring, for example, due to warm winds, or temporarily insufficient heating due to the outdoor sensor being exposed to direct sunshine.

In the information level, the outdoor temperature blinks on the display while delayed outdoor temperature adaptation is active. The calculated outdoor temperature is displayed.

Functions	WE	Configuration
Delayed OT adaptation when OT decreases	0	CO5 -> F05 - 1
Delayed OT adaptation when OT increases	0	CO5 -> F06 - 1
		3.0 °C Delay per hour / 1.0 to 6.0 °C

5.6 Remote operation

Apart from measuring the room temperature, the Type 5257-5 Room Panel (Pt 1000 sensor) provides the following opportunities of influencing the control process:

- ▶ Selection of the operating mode:
 - Automatic mode
 - Day mode
 - Night mode
- ▶ Set point correction: during rated operation, the room temperature set point can be increased or reduced by up to 5 °C using a continuously adjustable rotary knob.

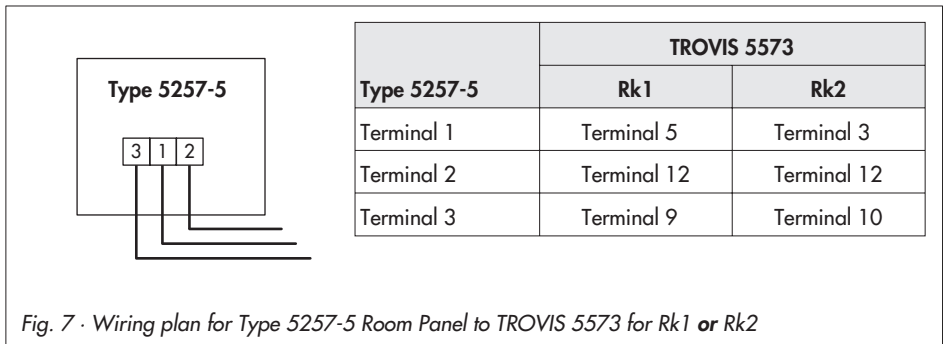

With an activated room sensor, the measured room temperature is displayed when the remote operation is connected and activated. Nevertheless, it is not used for control unless the **Optimization**, **Adaptation** or **Flash adaptation** functions have been activated.

Functions	WE	Configuration
Room sensor RF1/2	0	CO1, 2 -> F01 - 1

5.7 Optimization

This function requires the use of a room sensor. Depending on the building characteristics, the controller determines and adapts the required advance heating time (maximum 8 hours) to ensure that the desired *Day set point* (rated room temperature) has been reached in the reference room when the time-of-use starts. During the advance heating period, the controller heats with the max. flow temperature. This temperature is built up in steps of 10 °C. As soon as the *Day set point* has been reached, weather-compensated control is activated.

Depending on the room sensors, the controller switches off the heating system up to one hour before the time-of-use ends. The controller chooses the deactivation time such that the room temperature does not drop significantly below the desired value until the time-of-use ends.

During the advance heating period and the premature deactivation of the heating system, the icons ☼ or ☾ blink on the display.

Outside the times-of-use, the controller monitors the *Night set point* (reduced room temperature). When the temperature falls below the night set point, the controller heats with the max. flow temperature until the measured room temperature exceeds the adjusted value by 1 °C.

Note:

Direct sunshine can cause the room temperature to increase and thus result in the premature deactivation of the heating system.

When the room temperature decreases while the heating system is shortly outside its times-of-use, this can prematurely cause the controller to heat up to the Day set point.

Functions	WE	Configuration
Room sensors RF1/2	0	CO1, 2 -> F01 - 1
Outdoor sensor AF1	1	CO1 -> F02 - 1
Optimization	0	CO1, 2 -> F07 - 1
Parameters	WE	Switch position / Range of values
Day set point	20.0 °C	☼ / 0.0 to 40.0 °C
Night set point	15.0 °C	☾ / 0.0 to 40.0 °C

5.8 Flash adaptation

To ensure that the controller reacts immediately to room temperature deviations during rated or reduced operation, the function block setting CO1, 2 -> F09 - 1 needs to be made.

The heating is then always switched off as soon as the room temperature exceeds the *Day set point* or *Night set point* by 2 °C.

Heating first starts again when the room has cooled off and the room temperature is 1 °C above the *Set point*. The flow temperature set point is corrected if the *Cycle time* and *Gain K_p* are set to a value other than 0. The *Cycle time* determines the intervals at which the flow temperature set point is corrected by 1 °C. A *Gain K_p* set to a value other than 0 causes a direct increase/decrease in flow temperature set point when a sudden deviation in room temperature arises. A *Gain K_p* setting of 10.0 is recommended.

Note:

Cooling loads, such as drafts or open windows, affect the control process!

Rooms may be temporarily overheated after the cooling load has been eliminated!

Functions	WE	Configuration
Room sensors RF1/2	0	CO1, 2 -> F01 - 1
Flash adaptation	0	CO1, 2 -> F09 - 1
	20 min	Cycle time / 0 to 100 min
	0.0	KP (gain) / 0.0 to 25.0
Parameters	WE	Switch position / Range of values
Day set point	20.0 °C	↓☼ / 0.0 to 40.0 °C
Night set point	15.0 °C	↓☾ / 0.0 to 40.0 °C

5.8.1 Flash adaptation without outdoor sensor (room temperature dependent)

The flow temperature control starts with *Day set point for flow* in rated operation or with *Night set point for flow* in reduced operation as no set points calculated using characteristics exist without an outdoor sensor. The *Cycle time* determines the intervals at which the flow temperature set point is corrected by 1 °C. The heating is then always switched off as soon as the room temperature exceeds the *Day set point* or *Night set point* by 2 °C. Heating first starts again when the room has cooled off and the room temperature is 1 °C above the *Set point*. A *Gain Kp* set to a value other than 0 causes a direct increase/decrease in flow temperature set point when a sudden deviation in room temperature arises. A *Gain Kp* setting of 10.0 is recommended.

Functions	WE	Configuration
Room sensors RF1/2	0	CO1, 2 -> F01 - 1
Outdoor sensors AF 1/2	1	CO1, 2 -> F02 - 0
Flash adaptation	0	CO1, 2 -> F09 - 1
	20 min	Cycle time / 1 to 100 min
	0.0	KP (gain) / 0.0 to 25.0
Parameters	WE	Switch position / Range of values
Day set point	20.0 °C	↓☼ / 0.0 to 40.0 °C
Night set point	15.0 °C	↓☾ / 0.0 to 40.0 °C
Parameters	WE	Parameter level / Range of values
Day set point for flow	50.0 °C	PA1, 2 / 5.0 to 130.0 °C
Night set point for flow	30.0 °C	PA1, 2 / 5.0 to 130.0 °C

5.9 Adaptation

The controller is capable of automatically adapting the heating characteristic to the building characteristics, provided a gradient characteristic has been set (CO1, 2 -> F11 - 0). The reference room, where the room sensor is located, represents the entire building and is monitored to ensure that the room set point (*Day set point*) is maintained. When the mean measured room temperature in rated operation deviates from the adjusted set point, the heating characteristic is modified accordingly for the following time-of-use. The corrected value is displayed in PA1, 2 parameter levels under *Gradient, flow*.

Functions	WE	Configuration
Room sensors RF1/2	0	CO1, 2 -> F01 - 1
Outdoor sensors AF1/2	1	CO1, 2 -> F02 - 1
Adaptation	0	CO1, 2 -> F08 - 1
4-point characteristic	0	CO1, 2 -> F11 - 0
Parameters	WE	Switch position / Range of values
Day set point	20.0 °C	☼ / 0.0 to 40.0 °C
Night set point	15.0 °C	☾ / 0.0 to 40.0 °C

Note: If the **Flash adaptation** function is already configured with a small cycle time, the **Adaptation** function should not be configured as well.

6 Functions of the DHW circuit

6.1 DHW heating in the storage tank system

Start storage tank charging

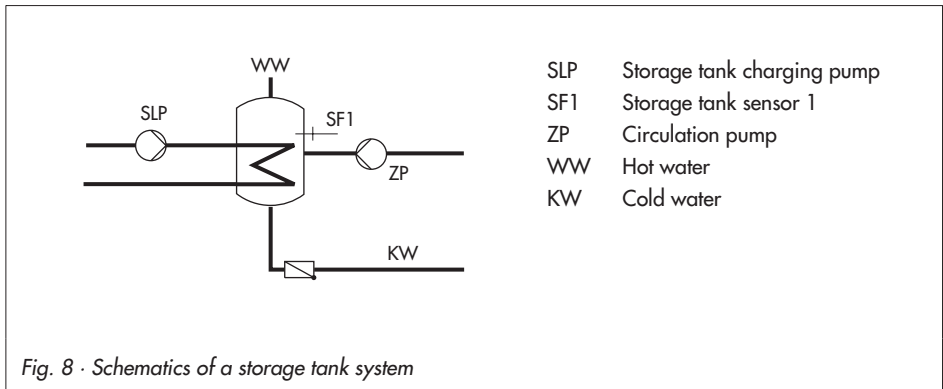

Fig. 8 · Schematics of a storage tank system

The controller begins charging the storage tank when the water temperature measured at sensor SF1 falls below the *DHW temperature set point* by 0.1 °C. If the flow temperature in the system exceeds the desired charging temperature, the controller tries to reduce the flow temperature in the heating circuit for up to 3 minutes before the storage tank charging pump is activated. When there is no heating operation or when the flow temperature in the system is lower, the storage tank charging pump is switched on immediately.

If the function CO4 -> F15 - 1 (**SLP ON depending on return flow temperature**) is activated, the primary valve is opened without simultaneously operating the storage tank charging pump. The storage tank charging pump is not switched on before the primary return flow temperature has reached the temperature currently measured at storage sensor SF1.

This function enables storage tank charging when the heating system is switched off, e.g. in summer mode, without cooling down the storage tank first by filling it with cold flow water. The storage tank charging pump does not start operation before a sufficiently high temperature has been reached at the heat exchanger.

Note: Instead of the DHW temperature parameter, the Charging temperature can be adjusted as the absolute value at the rotary switch if a storage tank thermostat is used.

Time-controlled switchover of storage tank sensors

By configuring a second storage tank sensor SF2 over the function block CO4 -> F19 -1, it is possible to determine that the storage tank sensor SF1 is used for day mode in the DHW circuit and that the storage tank sensor SF2 is used for night mode. As a result, different storage tank volumes can be kept at a constant temperature according to a time schedule, and also at different temperatures if the *DHW set point* and *Sustained DHW temperature* differ from one another.

Stop storage tank charging

The controller stops charging the storage tank when the water temperature measured at sensor SF1 has reached the temperature $T = \text{DHW temperature} + \text{hysteresis}$. When there is no heating operation or when the flow temperature demand in the system is lower, the corresponding valve is closed.

The storage tank charging pump is switched off after $t = \text{lag time of storage tank charging pump} \times \text{valve transit time}$.

With the default settings, the temperature in the storage tank is increased by 5 °C to reach 60 °C when the storage tank temperature falls below 55 °C. The charging temperature is calculated from the DHW temperature (55 °C) plus the *Charging temperature boost* (10 °C), which equals 65 °C. When the storage tank has been charged, the heating valve is closed and the charging pump continues operation for the time t (lag). Outside the times-of-use, the storage tank is only charged when the temperature falls below 40 °C (*Sustained DHW temperature*). In this case, the tank is charged with a charging temperature of 50 °C until 45 °C is reached in the tank.

Functions	WE	Configuration
Storage tank sensor SF1	1	CO4 -> F01 - 1
Storage tank sensor SF2		CO4 -> F02 (-1 when CO4 -> F19 - 1)
SLP ON depending on return flow temperature	0	CO4 -> F15
Time-controlled switchover of storage tank sensors	0	CO4 -> F19 (-1 only when CO4 -> F02 - 1)
Parameters	WE	Switch position / Range of values
DHW temperature set point or charging temperature set point with CO4 -> F01 - 0	55.0 °C	☼ / Min. to max. DHW temperature
Sustained DHW temperature	40.0 °C	☾ / Min. to max. DHW temperature
Parameters	WE	Parameter level / Range of values
Min. DHW temperature*	40.0 °C	PA4 / 5.0 to 90.0 °C

Parameters	WE	Parameter level / Range of values
Max. DHW temperature*	60.0 °C	PA4 / 5.0 to 90.0 °C
Hysteresis**	5.0 °C	PA4 / 0.0 to 30.0 °C
Charging temperature boost***	10.0 °C	PA4 / 0.0 to 50.0 °C
Lag of storage tank charging pump	1.0	PA4 / 0.0 to 10.0

* Parameters serve as limitation of the adjustment range for the DHW temperature to be set at the rotary switch

** Deactivation value $T = DHW\ temperature + hysteresis$

*** Charging temperature $T = DHW\ temperature + charging\ temperature\ boost$

6.1.1 DHW circuit additionally controlled by a globe valve

In system An1 11.1, the following version with globe valve can be configured instead of the three-way valve control in the DHW circuit:

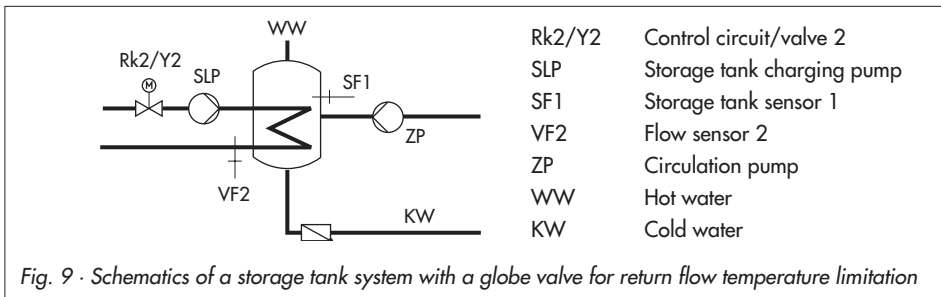

Globe valve and temperature sensor VF2 are used exclusively for return flow temperature limitation in the schematics shown above. The pre-control circuit provides at least the same flow temperature as in the standard schematic version which is calculated from *DHW temperature set point + Charging temperature boost + Boost set point of primary exchanger control*.

The functions and parameters of the DHW heating in the storage tank system are upgraded by the following settings:

Function	WE	Configuration
DHW circuit additionally controlled by a globe valve	0	CO4 -> F20 - 1
Parameter	WE	Parameter level / Range of values
Maximum return flow temperature	65.0 °C	PA4 / 20.0 to 90.0 °C

6.2 DHW heating in the storage tank charging system

Start storage tank charging

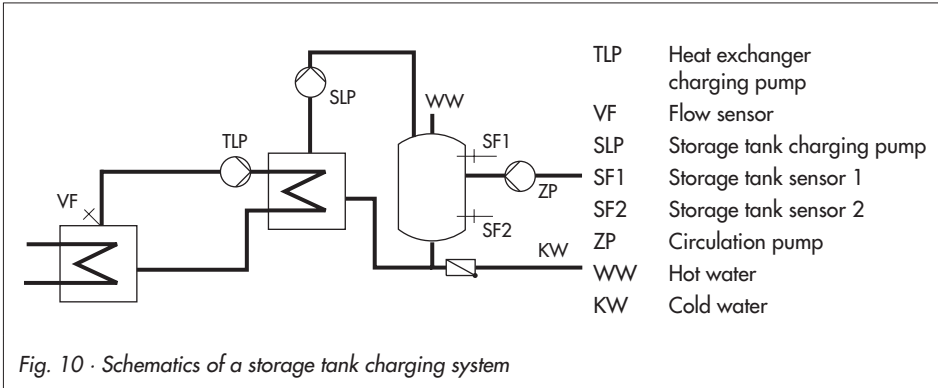

The controller begins charging the storage tank when the water temperature measured at sensor SF1 falls below the *DHW temperature set point* by 0.1 °C. If the flow temperature in the system exceeds the desired charging temperature, the controller tries to reduce the flow temperature in the heating circuit for up to 3 minutes before the exchanger charging pump is activated together with the storage tank charging pump.

When there is no heating operation or when the flow temperature in the system is lower, the exchanger charging pump is switched on immediately. If the temperature currently measured at sensor SF1 is reached at sensor VF or after three minutes at the latest, the storage tank charging pump is switched on.

If a storage tank thermostat is used, the storage tank charging pump is switched on when the temperature $T = \text{Charging temperature} - 5\text{ °C}$ is reached at sensor VF.

Note: *Instead of the DHW temperature parameter, the Charging temperature can be adjusted as the absolute value at the rotary switch if a storage tank thermostat is used.*

When the flow sensor VF4 is activated, the set point in the heat exchanger circuit is influenced by the system deviation in the storage tank charging circuit upon activation of the storage tank charging pump: if the temperature measured at flow sensor VF4 is lower than the desired charging temperature, the set point in the heat exchanger circuit is increased in steps of 1 °C.

When the set point in the heat exchanger charging circuit reaches the *Max. charging temperature*, the set point is no longer increased. An "Err 4" error message is generated.

Note: The set point in the heat exchanger circuit which is valid at the end of the charging cycle will be used again at the beginning of the next cycle.

If times-of-use have been set for DHW heating, the *DHW temperature set point* adjusted at the rotary switch is applied during these times-of-use. Outside the times-of-use, the *Sustained DHW temperature* is used. This does not apply when a storage tank thermostat is used.

Time-controlled switchover of storage tank sensors

By configuring a second storage tank sensor SF2 over the function block CO4 -> F19 -1, it is possible to determine that the storage tank sensor SF1 is used for day mode in the DHW circuit and that the storage tank sensor SF2 is used for night mode. As a result, different storage tank volumes can be kept at a constant temperature according to a time schedule, and also at different temperatures if the *DHW set point* and *Sustained DHW temperature* differ from one another.

Stop storage tank charging

The controller stops charging the storage tank when the water temperature measured at sensor SF2 has reached the temperature $T = \text{DHW temperature} + \text{hysteresis}$. To do so, the heat exchanger charging pump is switched off first.

When there is no heating operation or when the flow temperature demand in the system is lower, the corresponding valve is closed. The storage tank charging pump is switched off after $t = \text{Lag time of storage tank charging pump} \times \text{valve transit time}$.

Functions	WE	Configuration
Storage tank sensor SF1	1	CO4 -> F01 - 1
Storage tank sensor SF2	1	CO4 -> F02 - 1
Flow sensor VF4	0	CO4 -> F05
Time-controlled switchover of storage tank sensors	0	CO4 -> F19
Parameters	WE	Switch position / Range of values
DHW temperature set point or charging temperature set point with CO4 -> F01 - 0	55.0 °C	☀ / Min. to max. DHW temperature
Sustained DHW temperature	40.0 °C	☾ / Min. to max. DHW temperature
Parameters	WE	Parameter level / Range of values
Min. DHW temperature*	40.0 °C	PA4 / 5.0 to 90.0 °C
Max. DHW temperature*	60.0 °C	PA4 / 5.0 to 90.0 °C

Functions of the DHW circuit

Parameters	WE	Parameter level / Range of values
Hysteresis**	5.0 °C	PA4 / 0.0 to 30.0 °C
Charging temperature boost***	10.0 °C	PA4 / 0.0 to 50.0 °C
Max. charging temperature	80.0 °C	PA4 / 20.0 to 130.0 °C (only with VF4)
Lag of storage tank charging pump	1.0	PA4 / 0.0 to 10.0

* Parameters serve as limitation of the adjustment range for the DHW temperature to be set at the rotary switch

** Deactivation value $T = \text{DHW temperature} + \text{hysteresis}$

*** Charging temperature $T = \text{DHW temperature} + \text{charging temperature boost}$

6.3 DHW heating in instantaneous heating system

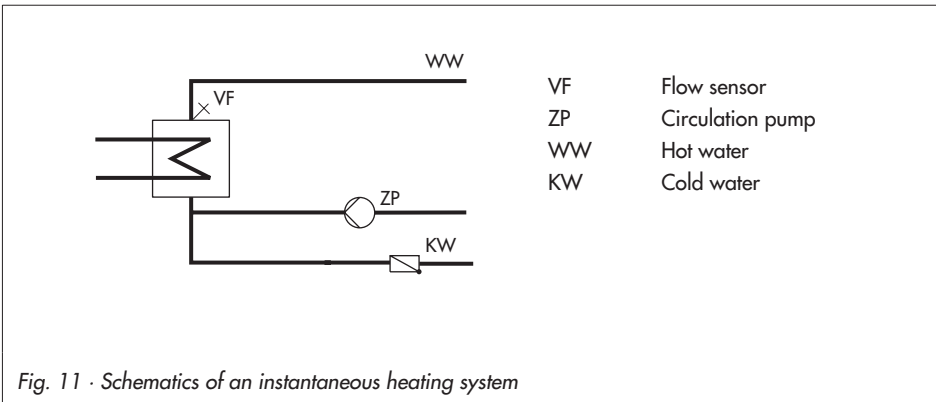

The control of the required *DHW temperature* at the flow sensor VF is only active during times-of-use of the circulation pump ZP.

Parameters	WE	Switch position / Range of values
DHW temperature set point	55.0 °C	☀ / Min. to max. DHW temperature
Sustained DHW temperature	40.0 °C	☁ / Min. to max. DHW temperature

Parameters	WE	Parameter level / Range of values
Min. DHW temperature	40.0 °C	PA4 / 5.0 to 90.0 °C
Max. DHW temperature	60.0 °C	PA4 / 5.0 to 90.0 °C

6.4 DHW heating with solar system

The systems An1 1.3 and 2.3 include a solar system for DHW heating. In these systems, the difference between the temperatures measured at storage sensor SF3 and the sensor at the solar collector VF3 is determined. The *Solar pump ON* parameter determines the minimum temperature difference between sensors VF3 and SF3 required to activate the solar pump. If the temperature difference falls below the value of *Solar pump OFF*, the solar pump is switched off. Basically, the solar pump is also switched off when the water temperature measured at sensor SF3 has reached the *Max. storage tank temperature*.

Note: *The times-of-use of the DHW circuit do not affect the operation of the solar system.*

After the key number 1999 has been set, the operating hours of the solar pump are displayed in extended information level.

Parameters	WE	Parameter level / Range of values
Solar pump ON	10.0 °C	PA4 / 1.0 to 30.0 °C
Solar pump OFF	3.0 °C	PA4 / 0.0 to 30.0 °C
Max. storage tank temperature	80.0 °C	PA4 / 20.0 to 90.0 °C

6.5 Intermediate heating operation

This function can only be activated in systems An1 2.x, 4.1 and 4.5. With the setting CO4 -> F07 - 1, heating operation of the UP1 heating circuit is reactivated for a period of 10 minutes after 20 minutes of priority (heating deactivated during DHW heating). By setting CO4 -> F07 - 0, storage tank charging is given unlimited priority over the heating operation in the UP1 heating circuit.

Function	WE	Configuration
Intermediate heating	1	CO4 -> F07 - 1

6.6 Parallel pump operation

This function can only be activated in systems An1 2.1 to 2.3, 4.1 and 4.5. With the setting CO4 -> F06 - 1, the circulation pump UP1 remains switched on during DHW heating unless certain operating situations occur. These situations include, for example, those when the current flow temperature demand of the pump circuit is lower than the adjusted *Flow limit temperature for parallel pump operation*. In this case, the controller applies priority operation, if necessary with intermediate heating. Once a parallel pump operation cycle has been activated and the

time for *Stop parallel operation in case of deviation* has elapsed, system deviations greater than 5 °C cause the controller to suspend parallel operation for 10 minutes and to apply priority operation. Setting *Stop parallel operation in case of deviation* to 0 min. leads to a parallel operation once initiated remaining regardless of a deviation.

Function	WE	Configuration
Parallel pump operation	0	CO4 -> F06 - 1
	10 min	Stop parallel operation in case of deviation /
	40.0 °C	0 to 10 min
		Flow limit temperature for parallel pump operation /
		20 to 90 °C

6.7 Circulation pump operation during storage tank charging

With the setting CO4 -> F11 - 1, the circulation pump (DHW) continues operation according to the programmed time schedule even during storage tank charging.

With the setting CO4 -> F11 - 0, the circulation pump is switched off as soon as the storage tank charging pump is activated. The circulation pump starts to operate again according to the time schedule when the storage tank charging pump has been switched off again.

Function	WE	Configuration
Circulation pump operation during storage tank charging	0	CO4 -> F11

6.8 Priority operation

In many district heating systems with primary DHW heating, the allotted amount of water cannot meet DHW heating and heating operation demands when they are required at the same time. As a result, the capacity required for DHW heating needs to be taken from the heating system when great heating loads occur; and this, until DHW demand has been concluded.

Nevertheless, heating operation is not to be interrupted simply. Only the amount of energy required for DHW heating is to be deducted. This can be achieved by using the priority functions **Reverse control** and **Set-back operation**.

6.8.1 Reverse control

In all systems with DHW heating and at least one heating circuit with control valve, DHW heating can be given priority by applying reverse control. With the setting CO4 -> F08 - 1, the temperature is monitored at sensor VFx.

In systems without the sensor VFx in the DHW circuit (e.g. Anl 4.5, Anl 11.0), the temperature directly at the storage sensor SF1 is monitored. If system deviations still occur after the time for

Activate priority in case of deviation has elapsed, the set point of the heating circuit with the control valve is gradually reduced each minute until the flow temperature set point has reached 5 °C at the minimum. How strongly the controller responds is determined by the *KP correction factor*.

Functions	WE	Configuration
Priority through reverse control	0	CO4 -> F08 - 1
	2 min	Activate priority in case of deviation / 2 to 10 min
	1.0	KP (correction factor) / 0.1 to 10.0
Priority through set-back operation	0	CO4 -> F09 - 0

6.8.2 Set-back operation

In all systems with DHW heating and at least one heating circuit with control valve, DHW heating can be given priority by applying set-back operation. With the setting CO4 -> F08 - 1, the temperature at sensor VFx can be monitored in the DHW circuit. In systems without the sensor VFx in the DHW circuit (e.g. Anl 4.5, Anl 11.0), the temperature directly at the storage sensor SF1 is monitored. If system deviations still occur after the time for *Activate priority in case of deviation* has elapsed, the heating circuit with control valve is set to reduced operation.

Functions	WE	Configuration
Priority through reverse control	0	CO4 -> F08 - 0
Priority through set-back operation	0	CO4 -> F09 - 1
	2 min	Activate priority in case of deviation / 2 to 10 min

6.9 Forced charging of the DHW storage tank

To provide the full network performance for room heating when the time-of-use of the heating circuits begins, any storage tanks are charged one hour before the time-of-use of the heating circuits starts.

For the individual controller, this means that storage tank charging is activated when the water temperature in the storage tank falls below the adjusted deactivation value of $T = \text{DHW temperature} + \text{hysteresis}$.

The forced charging of the storage tank does not take place when the DHW circuit is not used at the beginning of the time-of-use set for the heating circuit(s).

Note: This function is not available when a storage tank thermostat is used.

6.10 Thermal disinfection of the DHW storage tank

In all systems with DHW heating, a thermal disinfection is performed on a selected *Day of the week* or every day.

- ▶ In systems with DHW storage tank, it is heated up, taking into account the *Charging temperature boost* parameter (or *Set point boost*, depending on the system) to the adjusted *Disinfection temperature*. Disinfection begins at the adjusted *Start time* and, at the latest, ends at the specified *Stop time*.
- ▶ In systems with DHW heating in instantaneous heating system, the function remains active taking into account the *Set point boost* parameter until the circulation pipe, measured at SF1, has reached the adjusted *Disinfection temperature*, provided disinfection has not been terminated because the *Stop time* has been reached.

The *Hold time of disinfection temperature* determines how long the disinfection temperature must be maintained within the adjusted time period to rate the process successful. If the *Hold time of disinfection temperature* is set to a value other than 0, no intermediate heating operation takes place during thermal disinfection.

If the *Start time* and *Stop time* are set to the identical time, disinfection is controlled depending on the switching state of the binary input (terminals 03/12) to be performed daily or on the programmed day of the week: disinfection starts optionally with a break contact (bE=0) or a make contact (bE=1). It stops at the latest when the switching state of the binary input next changes.

When the *Disinfection temperature* has not been reached before the end of the thermal disinfection cycle, an "Err 3" error message is generated. This error message can also be generated prematurely if the remaining time until the disinfection temperature is reached is shorter than the adjusted *Hold time of disinfection temperature*. The error message is automatically reset when the *Disinfection temperature* is properly reached during the following thermal disinfection cycle.

Thermal disinfection for preventing legionella infection causes:

- ▶ excessively high return flow temperatures during the disinfection cycle (return flow temperature limitation suspended),
- ▶ excessively high DHW temperatures after thermal disinfection has been concluded,
- ▶ lime scale (possibly), which can have a negative effect on heat exchanger performance.

Note: This function is not available when a storage tank thermostat is used.

Functions	WE	Configuration
Storage tank sensor SF1	1	CO4 -> F01 - 1
Thermal disinfection	0	CO4 -> F14 - 1
	3	Day of the week / 1-7, 1, 2, ..., 7 with 1-7 = daily, 1 = Monday, ..., 7 = Sunday
	00:00	Start time / 00:00 to 23:45h; in steps of 15 minutes
	04:00	Stop time / 00:00 to 23:45h; in steps of 15 minutes
	70.0 °C	Disinfection temperature / 60.0 to 90.0 °C
	10.0 °C	Set point boost / 0 to 50 °C
	0 min	Hold time of disinfection time / 0 to 255 min
	bE=1	bE=1, bE=0 (start of disinfection with terminal 03/12 = ON, OFF; only applies when Start time = Stop time)

7 System-wide functions

7.1 Automatic summer time/winter time changeover

The clock is automatically adjusted on the last Sunday in March at 2.00h and on the last Sunday in October at 3.00h.

Function	WE	Configuration
Summer time/winter time changeover	1	CO5 -> F08 - 1

7.2 Frost protection

Frost protection measures are taken when the outdoor temperature falls below the *Frost protection limit*. The switching differential to cancel the frost protection measures is always 1 °C.

- ▶ Frost protection program I (restricted frost protection): frost protection measures are taken only when all heating circuits in the system are in stand-by mode. The circulation pumps are automatically switched on and their flow temperature set points are adjusted to 10 °C. The circulation pump in the DHW circuit is automatically switched on only when the stand-by mode has been adjusted at the rotary switch in all heating circuits. Nevertheless, the storage tank is always recharged to 10 °C if the storage tank temperature falls below 5 °C.
- ▶ Frost protection program II: the heating circuit circulation pumps are always switched on automatically. The flow temperature set points of all heating circuits currently in stand-by mode are set to +10 °C. In the DHW circuit, the circulation pump is always activated. If the storage tank temperature falls below +5 °C, the storage tank is recharged to +10 °C.

Functions	WE	Configuration
Frost protection program I		CO5 -> F09 - 0
	3.0 °C	Frost protection limit / -15.0 to 3.0 °C
Frost protection program II		CO5 -> F09 - 1
	3.0 °C	Frost protection limit / -15.0 to 3.0 °C

NOTICE

Frost protection operation of a pump, a heating circuit or the DHW circuit is only active when the frost protection icon ❄ appears on the display.

In the stand-by mode (⊖) fixed set point control without outdoor temperature sensor does not include frost protection.

7.3 Forced operation of the pumps

When the heating circuit pumps have not been activated for 24 hours, forced operation of the pumps is started between 12.02h and 12.03h. This is done to avoid that the pumps get stuck when they are not operated for a longer period of time. In the DHW circuit, the circulation pump is operated between 12.04h and 12.05h, the other pumps between 12.05h and 12.06h.

7.4 Return flow temperature limitation

The temperature difference between the flow and return flow indicates how well the energy is used: the greater the difference, the higher the efficiency. A return flow sensor is sufficient to evaluate the temperature difference when the flow temperatures are preset. The return flow temperature can be limited either to a value depending on the outdoor temperature (variable) or to a fixed set point. When the temperature measured at return flow sensor RüF exceeds the limit value, the set point of the flow temperature (flow temperature of the heating system, charging temperature) is reduced. As a result, the primary flow rate is reduced and the return flow temperature falls.

In systems Anl 2.x and 4.1, the *Max. return flow temperature* parameter (PA4 level) is used for limitation in the primary circuit during DHW heating if it is greater than the parameter valid for the primary circuit. The *Limiting factor* determines how strongly the controller responds when the limit values are exceeded in either direction (PI algorithm).

If just proportional component is to be implemented, set CO5 -> F16 - 1. This allows the integral-action component in the return flow temperature limitation algorithm of all control circuits of the controller to be deactivated. The set point reading (flow temperature of the heating, charging temperature) blinks to indicate that a return flow limitation is active in the control circuit concerned.

Note: *Using weather-compensated control with gradient characteristic, the return flow temperature is limited to a fixed value by equating the Return flow temperature foot and Max. return flow temperature (PA1, 2) parameters.*

Functions	WE	Configuration
Return flow sensors RüF1/2	1	CO1, 2, 4 -> F03 - 1
	1.0	KP (limiting factor) / 0.1 to 10.0
Return flow temperature limitation with P algorithm*	0	CO5 -> F16

* If CO5 -> F00 - 1 is indicated, access to the return flow, flow rate and heat capacity settings are locked.

System-wide functions

Parameters	WE	Parameter level / Range of values
Gradient, return flow	1.2	PA1, 2 / 0.2 to 3.2
Level, return flow	0.0 °C	PA1, 2 / -30.0 to 30.0 °C
Return flow temperature foot	65.0 °C	PA1, 2 / 5.0 to 90.0 °C
Max. return flow temperature	65.0 °C	PA1, 2, 4 / 5.0 to 90.0 °C

or

Parameter	WE	Parameter level / Range of values
Return flow temp. points 1 to 4	65.0 °C	PA1, 2 / 5.0 to 90.0 °C

NOTICE

To ensure that the preset return flow temperature limit can be met, make sure that

- the heating characteristic is not adjusted to ascend too steeply,
- the speed of the circulation pumps is not set too high,
- the heating systems have been calibrated.

7.5 Condensate accumulation control

Activate the **Limit deviation for OPEN signal** function to start up condensate accumulation plants, in particular to avoid problematic excess temperatures. The controller response to set point deviations which cause the primary valve to open is attenuated. The controller response to set point deviations which cause the control valve to close remains unaffected.

Note: The condensate accumulation control function can only be activated when the control circuit concerned is controlled using a PI algorithm (three-step control).

Functions	WE	Configuration
Control mode	1	CO1, 2, 4 -> F12 - 1
Limit deviation for OPEN signal	0	CO1, 2, 4 -> F13 - 1
	2.0 °C	Max. deviation / 2.0 to 10.0 °C

7.6 Three-step control

The flow temperature can be controlled using a PI algorithm. The valve reacts to pulses that the controller sends when a system deviation occurs. The length of the first pulse, in particular, depends on the extent of the system deviation and the selected *Proportional gain* K_P (the pulse length increases as K_P increases). The pulse and pause lengths change continuously until the system deviation has been eliminated. The pause length between the single pulses is greatly influenced by the *Reset time* T_N (the pause length increases as T_N increases).

The *Transit time* T_Y specifies the time required by the valve to travel through the range of 0 to 100 %.

Function	WE	Configuration
Control mode	1	CO1, 2, 4 -> F12 - 1, Rk_
	2.0	K_P (proportional gain) / 0.1 to 50.0
	120 s	T_N (reset time) / 1 to 999 s
	0 s	T_V (derivative-action time) / Do not change!
	45 s	T_Y (valve transit time) / 5, 10, 15, ... , 240 s

7.7 On/off control

The flow temperature can be controlled, for example, by activating and deactivating a boiler. The controller switches on the boiler when the flow temperature falls below the set point by $T = 0.5 \times \text{hysteresis}$. When the set point is exceeded by $T = 0.5 \times \text{hysteresis}$, the boiler is switched off again. The greater the value you choose for *Hysteresis*, the lower the activation/deactivation frequency will be. By setting the *Minimum ON time*, an activated boiler remains switched on during this period regardless of the flow temperature fluctuations. Similarly, a deactivated boiler will remain switched off regardless of the flow temperature fluctuations if the *Min. OFF time* has been specified.

Function	WE	Configuration
Control mode	1	CO1, 2, 4 -> F12 - 0
	5.0 °C	Hysteresis / 1.0 to 30.0 °C
	2 min	Min. ON time / 0 to 10 min
	2 min	Min. OFF time / 0 to 10 min

7.8 Continuous control in control circuit Rk1

The flow temperature in the control circuit Rk1 can be controlled using a PID algorithm. The valve in control circuit Rk1 receives an analog 0 to 10 V signal. When a system deviation occurs, the proportional component immediately causes the 0 to 10 V signal to change (the greater K_P , the greater the change). The integral component becomes effective with time: T_N

represents the time which elapses until the integral component has changed the output signal to the same extent as the immediate change performed by the proportional component (the greater T_N , the slower the rate of change). Due to the derivative component, any change of the system deviation is incorporated into the output signal with a certain gain (the greater T_V , the stronger the change).

Function	WE	Configuration
Control mode	1	CO1 -> F12 - 1
	2.0	KP (proportional gain) / 0.1 to 50.0
	120 s	Tn (reset time) / 1 to 999 s
	0 s	TV (derivative-action time) / 0 to 999 s
	45 s	TY (valve transit time) / 5, 10, 15, ..., 240 s

7.9 Releasing a control circuit/controller over the binary input

The release of an individual control circuit or the controller using the binary input only becomes effective when the respective control circuit is in automatic mode (icon ☉). The released control circuit always works in automatic mode; the deactivated control circuit behaves as if it were transferred to stand-by mode ☊.

It remains active, however, in any case for processing of external demand. The control circuit can be released via the binary input when the binary input is either a make contact ($bE = 0$) or a break contact ($bE = 1$).

Note:

In systems with supplementary heating circuit without a valve (Anl 2.x, 4.x), BE1 only influences the operation of this heating circuit.

In system Anl 3.0, BE1 influences the operation of the entire controller (except for processing of an external demand).

Functions	WE	Configuration
Release Rk1 at BE1	0	CO1 -> F14 - 1
	bE=1	bE=1, bE=0
Release Rk2 at BE2	0	CO2 -> F14 - 1
	bE=1	bE=1, bE=0
Release controller at BE1	0	CO5 -> F15 - 1
	1	bE=1, bE=0

7.10 Processing of external demand in control circuit Rk1

The controller can process binary or analog requests for an externally required signal by a more complex secondary system, provided the inputs SF2 or RF2 are not assigned to a sensor. The standard 0 to 10 V signal is basically interpreted as a 0 to 120 °C flow temperature demand, i.e. the flow temperature demand is 12 °C/V.

NOTICE

Overheating may occur in the heating circuits of the primary controller without control valve.

Excessive charging temperatures in DHW circuits without control valve controlled by the primary controller are excluded when the default settings of the controller are used: while storage tank charging is active, no flow temperature higher than the charging temperature is used by the primary controller. Nevertheless, if the **Priority for external demand** function is activated, the external demand is also processed during storage tank charging.

Function	WE	Configuration
Priority for external demand	0	CO4 -> F16 - 1

Processing of external demand with a binary signal

Regardless of the operating mode set for control circuit Rk1, except for manual mode, the flow temperature specified as *Set point for binary demand processing* is used in control circuit Rk1 when either the binary input (terminals 03/12) is a make contact (bE=1) or a break contact (bE=0).

Functions	WE	Configuration
Processing of external demand in Rk1	0	CO1 -> F15 - 1
Processing of external demand, 0 to 10 V	0	CO1 -> F16 - 0
Processing of external demand, binary	0 bE=1	CO1 -> F17 - 1 bE=1, bE=0
Parameter	WE	Parameter level / Range of values
Set point for binary demand processing	40.0 °C	PA1 / 5.0 to 130.0 °C

Processing of external demand with a 0 to 10 V signal

Regardless of the operating mode set for control circuit Rk1, except for manual mode, at least the flow temperature corresponding with the 0 to 10 V signal connected to terminals 11/12 is used by the controller.

Functions	WE	Configuration
Processing of external demand in Rk1	0	CO1 -> F15 - 1
Processing of external demand, 0 to 10 V	0	CO1 -> F16 - 1
Processing of external demand, binary	0	CO1 -> F17 - 0
Parameter	WE	Parameter level / Range of values
Set point boost of primary exchanger control	5.0 °C	PA1 / 0.0 to 50.0 °C

7.11 Creep feed rate limitation using a binary input

It is possible to report to the controller when the creep feed rate has fallen below a certain level by using a limit switch of the primary valve connected to the terminals 04/12. Either the open (bE=0) binary input or the closed binary input (bE=1) can be assigned to inform about the creep feed rate status. Shortly after the alert, the controller closes the valve Rk1. As soon as the flow temperature falls below the set point by more than 5 °C after the valve has been closed, control operation is started again.

Function	WE	Configuration
Creep feed rate limitation	0	CO5 -> F12 - 1
	bE=1	bE=0, bE=1

7.12 Locking manual level

To protect the heating system, this function can be used to lock the manual level. When this function has been activated, automatic mode is started when the rotary switch is set to  in automatic mode.

Function	WE	Configuration
Locking manual level	0	CO5 -> F21 - 1

7.13 Locking the rotary switch

When this function has been activated, the controller remains in automatic mode regardless of the rotary switch position. The rotary switch can no longer be used to adjust the controller settings. It is still possible to enter the key number.

Function	WE	Configuration
Locking the rotary switch	0	CO5 -> F22 - 1

7.14 Feeder pump operation

In system An1 3.0, the feeder pump UP1 only starts to operate in the default setting when a flow temperature demand of a secondary controller exists. If CO5 -> F14 - 1 is configured, this is also the case when the control circuit Rk2 requires heat.

Function	WE	Configuration
UP1 operation to cover own demand	0	CO5 -> F14 - 1

7.15 Setting a customized key number

To avoid the unauthorized modification of functions and parameters of the controller, the default key number can be replaced with an individual key number. Choose your custom key number between 0100 and 1900.

Proceed as follows:

1. Turn the rotary switch to \diamond (configuration and parameter level).
Display: **0000**
2. Set key number 1995 [\circ].
3. Confirm key number [\ast].
4. Enter valid key number [\circ].
5. Confirm key number [\ast].
Key number blinks.
6. Adjust desired custom key number [\circ].
7. Confirm custom key number [\ast].
This new key number is now valid.
8. Return rotary switch to the standard switch position \square (information level).

8 Operational faults

A sensor malfunction is indicated by the blinking  icon on the display. The "Error" message is displayed immediately. Press the rotary pushbutton to open the error level. It may be possible to view several error messages by turning the rotary pushbutton. As long as an error message is present, the error level is displayed, even though it has not been opened by pressing the rotary pushbutton.

In the error level, the error message is displayed as specified in the list below (section 8.1).



Note: After the system code number has been changed or after restarting the controller, any error messages are suppressed for approx. three minutes.

8.1 Error list

- ▶ Err 1 = Sensor failure (-> section 8.2)
- ▶ Err 2 = Reserved
- ▶ Err 3 = Disinfection temperature not reached (-> section 6.10)
- ▶ Err 4 = Max. charging temperature reached (-> section 6.2)
- ▶ Err 5 = Reserved
- ▶ Err 6 = Temperature monitoring alarm (-> section 8.3)
- ▶ Err 7 = Unauthorized access occurred (-> section 9.1)

All error messages, except for "Err 1" can be confirmed in the error level.

When an error message is indicated, proceed as follows:

1. Select *Clr* on the display [].
2. Confirm the error message [].

8.2 Sensor failure

According to the error list, sensor failures are indicated by displaying “Err 1” error message in the error level. For detailed information, exit error level and view the different temperature values in the information level: each sensor icon displayed together with 3 horizontal lines instead of the measured value indicates a defective sensor. The following list explains how the controller responds to the failure of the different sensors.

- ▶ **Outdoor sensor AF1:** When the outdoor sensor fails, the controller uses a flow temperature set point of 50 °C or the *Max. flow temperature* when the *Max. flow temperature* (adjusted under PA1, 2) is lower than 50 °C.
- ▶ **Flow sensor(s) in heating circuit(s):** When the flow sensors in the heating circuits are defective, the associated valve moves to 30 % travel. DHW heating using such a sensor to measure the charging temperature is suspended.
- ▶ **Flow sensors in the DHW circuit with control valve:** When the flow sensor VF4 fails, the controller behaves as if VF4 had not been configured. As soon as the control of the charging temperature becomes impossible (VF2 defective), the associated valve is closed.
- ▶ **Return flow sensors RÜF1/2:** When the return flow sensor fails, the controller continues operation without return flow temperature limitation.
- ▶ **Room sensors RF1/2:** When the room sensor fails, the controller uses the settings for operation without room sensor. The controller, for example, switches from optimizing mode to reduced operation; adaptation mode is canceled. The last determined heating characteristic remains unchanged.
- ▶ **Storage tank sensors SF1/2:** When one of the two sensors fails, the storage tank is no longer charged (exception: solar system).
- ▶ **Solar sensors SF3, VF3:** When one of the two sensors fails, the storage tank in the solar circuit is no longer charged.

8.3 Temperature monitoring

When a system deviation greater than 10 °C persists in a control circuit for 30 minutes, an “Err 6” error message (temperature monitoring alarm) is generated.

Function	WE	Configuration
Temperature monitoring	0	CO5 -> F19 - 1

8.4 Error status register

The error status register is used to indicate controller or system errors. In modem operation mode when the controller dials the building control system (GLT) both when an error is detected and when it has been corrected, each change in the status of the error status register causes the

controller to dial the control system. You can define which error messages are to influence the error status register after entering the key number 0025. The default setting of 465 results in just the error messages highlighted in the table (bold) causing a change in state of the error status register.

Error message	Meaning	Decimal value		
Err 1	Sensor failure	1	1	1
Err 2	–	2		
Err 3	Disinfection temperature not reached	4		
Err 4	Max. charging temperature reached	8		
Err 5	–	16	16	
Err 6	Temperature monitoring alarm	32		32
Err 7	Unauthorized access occurred	64	64	
Err 8	–	128	128	
Err 9	–	256	256	
			Total	Total
Default setting range after entering the key number 0025 =			465	
Example: Value of error status register when a sensor fails and a temperature monitoring alarm=				33

8.5 Sending text messages in case of error

If a dial-up modem is connected to RS-232/modem communications module (-> section 9.1), the controller can send a text message to a mobile phone when an error occurs.

As soon as a fault has been registered in the error status register, the text message indicating a controller fault is sent. On the mobile phone, the following error message is displayed:

[Date]	[Time]
[Phone no. of the controller]	
Controller fault	
TROVIS 5573 # [controller ID of the faulty controller]	

The time stamp [Date], [Time] is added by the text messaging center, not by the controller. If an error message is transmitted via the device bus to a controller equipped with a dial-up modem, the controller ID of the faulty controller is sent, instead the controller ID of the "modem controller". A detailed error message is not available.

Note: The controller ID is indicated in the extended information level under Info 2 listed as the first value in the sequence (-> section 1.8).

When Modbus is activated and, at the same time, the dial-up in case of error is released, the connection with the building control station is established first, and then the text message is sent. If the first attempt to connect to the building control station fails, the controller tries again until the programmed number of redialing attempts has been exhausted.

In Germany, the access numbers (TAPnr) of the SMS service center are currently:

- ▶ **D1** network: 0171 252 1002 (alternatively, 0171 252 1099 is also possible)
- ▶ **E-Plus** network: 0177 1167
- ▶ **Cellnet (UK)** network: 0044 786 098 0480 – routing into the **D1**, **D2** and **E-Plus** networks.

Add "0" to the number when dialing from a telephone extension. The mobile phone number (HAndi) must be entered as follows: 49 xxx yyyyyy, where xxx stands for 160, 171 or any other valid dialing code and yyyyyy represents the specific phone number of the mobile you wish the error message to be sent to.

Functions	WE	Configuration
Text message	0	CO6 -> F08 - 1
Modem function	0	CO6 -> F03 - 1
Automatic modem configuration	0	CO6 -> F04 - 1
Parameters*	WE	Parameter level / Range of values
Modem dialing pause (P)	5 min	PA6 / 0 to 255 min
Modem timeout (T)	5 min	PA6 / 1 to 255 min
No. of redialing attempts (C)	15	PA6 / 1 to 255
Access number (TAPnr)	-	PA6 / Max. 22 characters; 1, 2, 3, ..., 9, 0; ". " end of a string; "P" pause
Mobile phone number (HAndi)	-	PA6 / Max. 22 characters; 1, 2, 3, ..., 9, 0; ". " end of a string; "P" pause

* -> section 9.3 (Description of communication parameter settings)

9 Communication

Using the optional communications module, the TROVIS 5573 Controller can communicate with a building control system. In combination with a suitable software for process visualization and communication, a complete control system can be implemented. The following communication settings are possible:

– **Operation with a dial-up modem to the RS-232/modem communications module**

Basically, communication is only established automatically when errors occur. The controller works autonomously. Nevertheless, the modem can dial up to the controller at any time to read data from it or otherwise influence it, if necessary.

– **Operation on a two-wire bus to the RS-485 communications module**

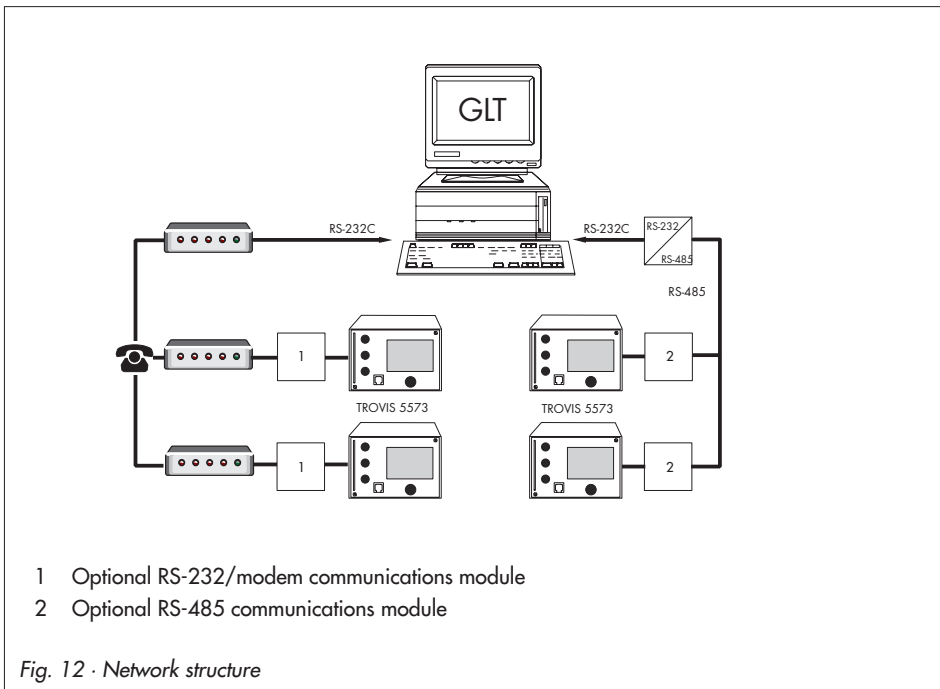

Note: The operating software can be updated over the modem or a data cable, provided Modbus is activated by configuring CO6 -> F01 - 1.

9.1 RS-232/modem communications module

When looking onto the controller front, the connection for the **optional** communications module is located on the left side in the controller housing (RJ-45 jack). A dial-up modem can be connected to the controller over the RS-232/modem communications module.

A dial-up modem is required in case the controller is to be connected to the telecommunications network. In this case, the controller works autonomously and can issue an alarm call to the building control station when errors occur. Additionally, the building control station can dial up to the controller, read data from it, and send new data once the valid key number has been written to holding register no. 40145.

Note: *If a wrong key number has been written to holding register no. 40145 for the third consecutive time, the controller immediately interrupts the modem connection and generates an "Err 7" error message (Unauthorized access occurred). As a result, the call to the configured control system is triggered and a text message is sent. Bit D6 is deleted as soon as the error status register has been read by the control system and the connection has been terminated.*

In special cases, the **Lock dial-up** function can be selected to stop dial-up in case an error occurs. Using the **Dial-up also upon corrected error** function, the controller additionally informs the building control station when a previously signaled error no longer persists.

Thanks to the **Automatic modem configuration** function, the dial-up modem connected to the controller does not need to be preset; it is configured automatically by the controller.

Functions	WE	Configuration
Modbus	1	CO6 -> F01 - 1
Modbus 16-bit addressing	0	CO6 -> F02
Modem function	0	CO6 -> F03 - 1
Automatic modem configuration	0	CO6 -> F04 - 1
Lock dial-up	0	CO6 -> F05
Dial-up also upon corrected error	0	CO6 -> F06
Control system monitoring	0	CO6 -> F07 - 0
Parameters*	WE	Parameter level / Range of values
Station address (ST)	255	PA6 / 1 to 247 with CO6 -> F02 - 1: 1 to 32000
Modem dialing pause (P)	5 min	PA6 / 0 to 255 min
Modem time-out (T)	5 min	PA6 / 1 to 255 min
No. of redialing attempts (C)	5	PA6 / 1 to 255

Parameters*	WE	Parameter level / Range of values
Phone no. of control station (TELnr) –		PA6 / Max. 22 characters; 1, 2, 3, ...9, 0; “-” end of a string, “P” pause

* -> section 9.3 (Description of communication parameter settings)

9.2 RS-485 communications module

When looking onto the controller front, the connection for the **optional** communication module is located on the left side in the controller housing (RJ-45 jack). A constant bus connection is required (data cable) to operate the controller together with the RS-485 communication module. The bus line links the control units/devices in an open ring. At the end of the bus line, the data cable is connected to the control station using a RS-485/RS-232 converter (e.g. CoRe01, refer to Data Sheet T 5409 EN).

The maximum range of the bus connection (cable length) is 1,200 meters. A maximum of 126 devices can be connected to such a segment. For greater distances or when more than 126 devices are to be connected to a line, repeaters (e.g. CoRe01) must be used to regenerate the level. A maximum of 246 devices with 8-bit addressing can be connected to a bus.

If no communication is established between the control system and controller, the time of any access by the control system to dynamic process can be restricted by the **Control system monitoring** function.

The controller resets the monitoring function, provided the valid Modbus requests are registered. However, in case of an error, all level bits are initialized back to “autonomous” after 30 minutes have elapsed.

NOTICE

You are required to follow the relevant standards and regulations concerning lightning and surge protection on installation.

Functions	WE	Configuration
Modbus	1	CO6 -> F01 - 1
Modbus16-bit addressing	0	CO6 -> F02
Modem function	0	CO6 -> F03 - 0
Control system monitoring	0	CO6 -> F07

Parameters*	WE	Parameter level / Range of values
Station address (ST.-NR)	255	PA6 / 1 to 247 with CO6 -> F02 - 1: 1 to 32000

* -> section 9.3 (Description of communication parameter settings)

9.3 Description of communication parameter settings

Station address (ST)

This address is used to identify the controller in bus or modem mode. In a system, each controller needs to be assigned a unique address.

Modem dialing pause (P)

It is recommendable to pause for approx. 3 to 5 minutes between dialing up to the control system/the text messaging center to avoid a permanent overloading of the telecommunications network. The *Modem dialing pause* defines the interval between 2 dialing attempts.

Modem time-out (T)

When the controller connects to the control station (GLT) but without addressing a Modbus data point, the connection is terminated after the time specified for *Modem time-out* has elapsed. If the error status register has not been read during the GLT connection, the controller dials up the GLT again after the *Modem dialing pause (P)* has elapsed.

When sending a text message, the specified time is without meaning.

Number of redialing attempts (C)

The controller tries to dial up to the control system again, observing the *Modem dialing pause*, in case the GLT/text messaging center is busy or the function that triggered the call has not been reset by the controller. After the specified number of redialing attempts have failed, "OFF" is indicated in the controller's extended information level. The dialing attempt counter is automatically reset at 12:00h and the controller tries to connect again.

Resetting of triggered call = Reading the error status registers (HR40150)

Phone number of control station (TELnr)

Enter the phone number of the control system modem including the dialing code, if necessary. Short pauses between the numbers can be entered using P (= 1 second); the end of the string is to be marked by "-". The phone number may include a maximum of 22 characters.

Example: "069, 2 sec. pause, 4009, 1 sec. pause, 0":

0 6 9 P P 4 0 0 9 P 0 - (= 11 characters)

Note: *The connected modem is automatically configured when the function block CO6 -> F04 - 1 is activated.*

9.4 Memory module

The use of a memory module (order no. 1400-9379) is particularly useful to transfer all data from one TROVIS 5573 Controller to several other TROVIS 5573 Controllers.

The memory module is plugged into the RJ-45 jack at the side. Once the module has been connected, "73 SP" is displayed. If the memory module already contains data from a different TROVIS 5573 Controller, turn the rotary pushbutton until "SP 73" is displayed.

- ▶ Pressing the rotary pushbutton to confirm "73 SP" causes the controller settings to be transferred to the memory module.
- ▶ Pressing the rotary pushbutton to confirm "SP 73" causes the saved controller settings to be transferred from the memory module to the controller.

During the data transfer, the bars on the display indicate the progress. When the transfer was successful, "I.O." is displayed. After that, the connection between controller and memory module can be terminated.

Using TROVIS-VIEW (order no. 6661-1014), it is possible to configure all controller settings in a convenient user interface on the PC and to document these settings.

9.5 Data logging

A data logging module (order no. 1400-9378) saves the following controller data every two minutes:

- ▶ Temperatures measured by the sensors
- ▶ Control signals [%]
- ▶ Switching states of the pump outputs
- ▶ Error status register and its archive data
- ▶ Access to the controller settings

The data logging module is connected to the RJ-45 jack at the side of the controller.

The controller starts to write over the oldest data as soon the memory of the data logging module is full after approximately eight days. The current memory capacity of the data logging module can be read in the extended information level under *Info 2* as the second in the sequence (range of values: 0 to 6035). Directly after inserting the data logging module, data can be first read after the first scanning cycle has been performed.

The Datalogging Viewer software allows the data to be viewed in graph format. The USB converter 3 (order no. 1400-9377) is required to connect the data logging module to a computer. The Datalogging Viewer software is supplied with the USB converter 3.

10 Installation

The controller consists of the housing with the electronics and the back panel with the terminals. It is suitable for panel, wall and top hat rail mounting (Fig. 13).

Panel mounting

1. Remove both screws (1).
2. Pull apart the controller housing and the back panel.
3. Make a cut-out of 138 x 92 mm (W x H) in the control panel.
4. Insert the controller housing through the panel cut-out.
5. Tighten the two screws (2) to clamp the controller housing against the control panel.
6. Connect the electrical wiring at the back of the housing as described in section 11.
7. Fit the controller housing.
8. Fasten both screws (1).

Wall mounting

1. Remove both screws (1).
2. Pull apart the controller housing and the back panel.
3. If necessary, drill holes with the specified dimensions in the appropriate places.
Fasten the back panel with four screws.
4. Connect the electrical wiring at the back of the housing as described in section 11.
5. Remount the controller housing.
6. Fasten both screws (1).

Top hat rail mounting

1. Fasten the spring-loaded hook (4) at the bottom of the top hat rail (3).
2. Slightly push the controller upwards and pull the upper hook (5) over the top hat rail.
3. Remove both screws (1).
4. Pull apart the controller housing and the back panel.
5. Install the electrical connections at the back panel as described in section 11.
6. Remount the controller housing.
7. Fasten both screws (1).

Panel mounting

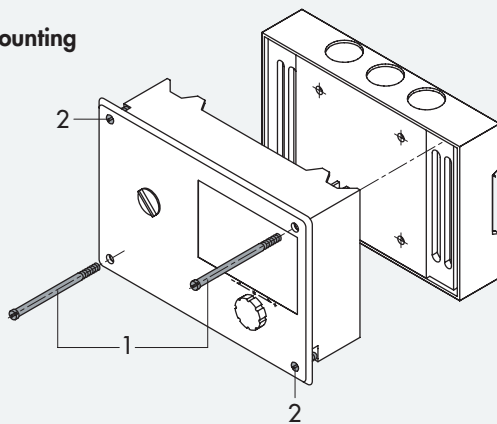

Wall mounting

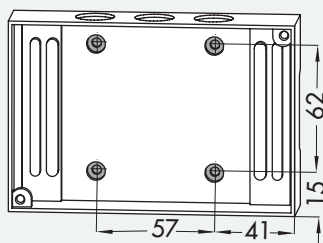

Top hat rail mounting

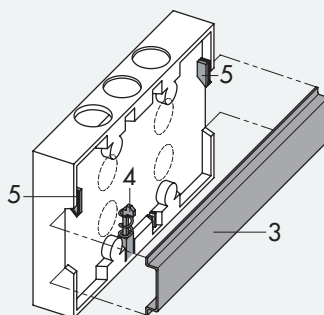

Fig. 13 · Installation

11 Electrical connection

Danger!

Risk of electric shock!

For electrical installation, you are required to observe the relevant electrotechnical regulations of the country of use as well as the regulations of the local power suppliers. Make sure all electrical connections are installed by trained and experienced personnel!

Notes on installing the electrical connections

- ▶ Install the 230 V power supply lines and the signal lines separately! To increase noise immunity, observe a minimum distance of 10 cm between the lines. Make sure the minimum distance is also observed when the lines are installed in a cabinet.
- ▶ The lines for digital signals (bus lines) and analog signals (sensor lines, analog outputs) must also be installed separately!
- ▶ In plants with a high electromagnetic noise level, we recommend to use shielded cables for the analog signal lines. Ground the shield at one side, either at the control cabinet inlet or outlet, using the largest possible cross-section. Connect the central grounding point and the PE grounding conductor with a cable $\geq 10 \text{ mm}^2$ using the shortest route.
- ▶ Inductances in the control cabinet, e.g. contactor coils, are to be equipped with suitable interference suppressors (RC elements).
- ▶ Control cabinet elements with high field strength, e.g. transformers or frequency converters, should be shielded with separators providing a good ground connection.

Overvoltage protection

- ▶ If signal lines are installed outside buildings or over large distances, make sure appropriate surge or overvoltage protection measures are taken. Such measures are indispensable for bus lines!
- ▶ The shield of signal lines installed outside buildings must have current conducting capacity and must be grounded on both sides.
- ▶ Surge diverters must be installed at the control cabinet inlet.

Connecting the controller

The controller is connected as illustrated in the following wiring diagram.

Open the housing to connect the cables. To connect the feeding cables, make holes in the marked locations at the top, bottom or back of the rear part of the housing and fit suitable grommets or cable glands.

Connecting the sensors

Cables with a minimum cross-section of $2 \times 0.5 \text{ mm}^2$ can be connected to the terminals at the back panel of the housing.

Connecting the actuators

- ▶ 0 to 10 V control output:
Use cables with a minimum cross-section of $2 \times 0.5 \text{ mm}^2$.
- ▶ Three-step or on/off outputs:
Connect cables with at least 1.5 mm^2 suitable for damp locations to the terminals of the controller output. The direction of travel needs to be checked at start-up.

Connecting the pumps

Connect all cables with at least 1.5 mm^2 to the terminals of the controller as illustrated in the wiring diagram.

CAUTION!

The electric actuators are not automatically supplied with a voltage by the controller. They can be connected over terminals 25 and 28 to an external voltage source. If this is not the case, connect a jumper from terminal 18 to terminals 25 and 28.

Legend for wiring diagram:

AF	Outdoor sensor	CP	Solar circuit pump
BE	Binary input	Rk	Control circuit
FG	Potentiometer	UP	Circulation pump
RF	Room sensor	SLP	Storage tank charging pump
RüF	Return flow sensor	TLP	Heat exchanger charging pump
SF	Storage tank sensor	ZP	Circulation pump (DHW)
VF	Flow sensor		

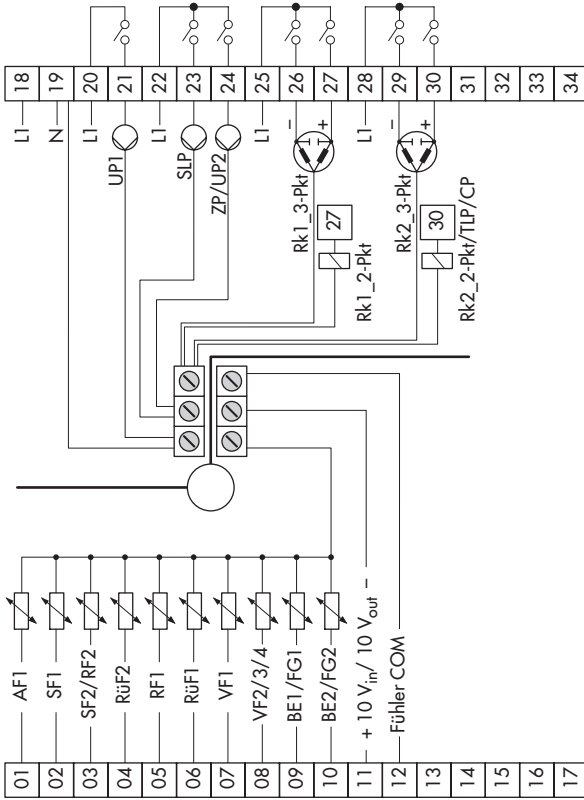

Fig. 14 · Connecting the TROVIS 5573 Controller

12 Appendix

12.1 Function block lists

CO1: Rk1· Heating circuit 1 (not system Anl 1.9)*

F	Function	WE	Anl	Comment Function block parameters / Range of values (default)
01	Room sensor RF1	0	Not in Anl 1.5, 1.6, 3.x	CO1 -> F01 - 1: Temperature display and input FG1 for Type 5244/5257-5 Room Panel active TROVIS 5570 Room Panel: CO1 -> F01 - 1 and CO7 -> F03 - 1
02	Outdoor sensor AF1	0	1.5, 1.6	CO1 -> F02 - 1: Weather-compensated control active
		1	Not in Anl 1.5, 1.6	
03	Return flow sensor RfF1	0	1.2	CO1 -> F03 - 1: Sensor and limiting function active Function block parameter: KP (limiting factor) / 0.1 to 10.0 (1.0)
		1	Not in Anl 1.2	
04	Reserved			
05	Underfloor heating Drying of jointless floors	0	Not in Anl 1.5, 1.6, 3.x	CO1 -> F05 - 1: Limitation of the adjustment ranges Function block parameters: Start temperature / 20 to 60 °C (25 °C) Temperature rise per day / 1.0 to 10.0 °C (5.0 °C) Maximum temperature / 25.0 to 60.0 °C (45.0 °C) Maintaining time of max. temp. / 0 to 10 days (4 days) Temperature reduction per day / 0.0 to 10.0 °C (0.0 °C) SToP, ■ STArT, ■■ STArT, ■■■ STArT
06	Reserved			
07	Optimization	0	Not in Anl 1.5, 1.6, 3.x	CO1 -> F07 - 1: Only with <ul style="list-style-type: none"> • CO1 -> F01 - 1 • CO1 -> F02 - 1
08	Adaptation	0	Not in Anl 1.5, 1.6, 3.x	CO1 -> F08 - 1: Only with <ul style="list-style-type: none"> • CO1 -> F01 - 1 • CO1 -> F02 - 1 • CO1 -> F11 - 0
09	Flash adaptation	0	Not in Anl 1.5, 1.6, 3.x	CO1 -> F09 - 1 Only with CO1 -> F01 - 1 Function block parameters: Cycle time / 0 or 1 to 100 min (20 min) KP (gain) / 0.0 to 25.0 (0.0)
10	Reserved			

F	Function	WE	Anl	Comment Function block parameters / Range of values (default)
11	4-point characteristic	0	Not in Anl 1.5, 1.6, 3.x	CO1 -> F11 - 1: 4-point characteristic, only with CO1 -> F08 - 0 CO1 -> F11 - 0: Gradient characteristic
12	Control mode	1	All*	CO1 -> F12 - 1: three-step control Function block parameters: KP (proportional gain) / 0.1 to 50.0 (2.0) Tn (reset time) / 1 to 999 s (120 s) TV (derivative-action time) / 0 to 999 s (0 s) TY (valve transit time) / 5, 10, 15, ..., 240 s (45 s) CO1 -> F12 - 0: On/off control Function block parameters: Hysteresis / 1.0 to 30.0 °C (5.0 °C) Min. ON time / 0 to 10 min (2 min) Min. OFF time / 0 to 10 min (2 min)
13	Limitation of deviation for OPEN signal	0	All*	CO1 -> F13 - 1 only with CO1 -> F12 - 1 Function block parameter: Max. deviation / 2.0 to 10.0 °C (2.0 °C)
14	Release Rk1 at BE1	0	All*	With CO1 -> F14 - 1, FG1 has no function; Options bE= 1, bE=0 (bE=1)
15	Processing of external demand in Rk1	0	All*	How the external demand is processed in Rk1 depends on CO1 -> F16, CO1 -> F17 and CO7 -> F15.
16	Processing of external demand, 0 to 10 V Input term. 11/12	0	All*	CO1 -> F16 - 1: Only with <ul style="list-style-type: none">• CO1 -> F15 - 1• CO1 -> F17 - 0 The standard signal output (terminals 11/12) is not available anymore as a control output.
17	Processing of external demand, binary Input term. 03/12	0	Not in Anl with SF2/RF2	CO1 -> F17 - 1: Only with <ul style="list-style-type: none">• CO1 -> F15 - 1• CO1 -> F16 - 0 Options bE= 1, bE=0 (bE=1)
18	Request max. flow set point over a 0 to 10 V signal	0	All*	CO1 -> F18 - 1: The standard signal output (terminals 11/12) is not available anymore as a control output. Function block parameters: Lower transmission range: 0.0 to 130.0 °C (0.0 °C) Upper transmission range: 0.0 to 130.0 °C (120.0 °C)

F Function block number, WE Default value, Anl System code number

CO2: Rk2 · Heating circuit 2 (systems Anl 3.x, 4.x and 10.0)*

F	Function	WE	Anl	Comment Function block parameters / Range of values (default)
01	Room sensor RF2	0	All*	CO2 -> F01 - 1: Temperature display and input FG2 for Type 5244/5257-5 Room Panel active TROVIS 5570 Room Panel: CO2 -> F01 - 1 and CO7 -> F04 - 1
02	Reserved			
03	Return flow sensor RüF2	1	10.x	CO2 -> F03 - 1: Sensor and limiting function active
		0	3.0, 4.x	Function block parameter: KP (limiting factor) / 0.1 to 10.0 (1.0)
04	Reserved			
05	Underfloor heating Drying of jointless floors	0	All*	CO2 -> F05 - 1: Limitation of the adjustment ranges Function block parameters: Start temperature / 20 to 60 °C (25 °C) Temperature rise per day / 1.0 to 10.0 °C (5.0 °C) Maximum temperature / 25.0 to 60.0 °C (45.0 °C) Maintaining time of max. temp. / 0 to 10 days (4 days) Temperature reduction per day / 0.0 to 10.0 °C (0.0 °C) SToP, ■ STArT, ■■ STArT, ■■■ STArT
06	Reserved			
07	Optimization	0	All*	CO2 -> F07 - 1: Only with <ul style="list-style-type: none"> • CO2 -> F01 - 1 • CO1 -> F02 - 1
08	Adaptation	0	All*	CO2 -> F08 - 1: Only with <ul style="list-style-type: none"> • CO2 -> F01 - 1 • CO1 -> F02 - 1 • CO2 -> F11 - 0
09	Flash adaptation	0	All*	CO2 -> F09 - 1: Only with CO2 -> F01 - 1 Function block parameters: Cycle time / 0 or 1 to 100 min (20 min) KP (gain) / 0.0 to 25.0 (0.0)
10	Reserved			
11	4-point characteristic	0	All*	CO2 -> F11 - 1: 4-point characteristic, only with CO2 -> F08 - 0 CO2 -> F11 - 0: Gradient characteristic

F	Function	WE	Anl	Comment Function block parameters / Range of values (default)
12	Control mode	1	All*	CO2 -> F12 - 1: Three-step control Function block parameters: KP (proportional gain) / 0.1 to 50.0 (2.0) Tn (reset time) / 1 to 999 s (120 s) TV (derivative-action time) / 0 s; Do not change! TY (valve transit time) / 5, 10, 15, ..., 240 s (45 s) CO2 -> F12 - 0 (only in system Anl 10.0): On/off control Function block parameters: Hysteresis / 1.0 to 30.0 °C (5.0 °C) Min. ON time / 0 to 10 min (2 min) Min. OFF time / 0 to 10 min (2 min)
13	Limit deviation for OPEN signal	0	All*	CO2 -> F13 - 1: Only with CO2 -> F12 - 1 Function block parameter: Max. deviation / 2.0 to 10.0 °C (2.0 °C)
14	Release Rk2 at BE2	0	All*	CO2 -> F14 - 1: FG2 has no function Select bE= 1, bE=0 (bE=1)

F Function block number, WE Default value, Anl System code number

CO4: DHW heating (systems Anl 1.1–1.3, 1.5, 1.6, 1.9, 2.x, 4.1, 4.5, 11.x)*

F	Function	WE	Anl	Comment Function block parameters / Range of values (default)
01	Storage tank sensor SF1	1	1.1–1.3, 1.5, 1.6, 2.x, 4.1, 4.5, 11.0, 11.2	CO4 -> F01 - 0 (not in Anl 11.0): Storage tank thermostat, only with CO4 -> F02 - 0
		0	1.9, 11.9	
02	Storage tank sensor SF2 with Stop storage tank charging function (not assigned to solar circuit)	0	1.1, 1.3, 1.5, 2.0, 2.1, 2.3, 4.1, 4.5, 11.0, 11.1	CO4 -> F02 - 1 (not in Anl 1.3, 1.9, 2.3, 11.0 and 11.9): Only with CO4 -> F01 - 1
		1	1.2, 1.6, 2.2, 11.2	
03	Return flow sensor RüF2	0	1.9, 11.x	CO4 -> F03 - 1: Sensor and limiting function active; Function block parameter: KP (limiting factor) / 0.1 to 10.0 (1.0)
04	Reserved			
05	Flow sensor VF4	0	1.1, 1.2, 1.6, 2.2, 11.2	CO4 -> F05 - 1: Flow sensor VF4 to measure the storage tank charging temperature active
06	Parallel pump operation	0	2.1–2.3, 4.1, 4.5	CO4 -> F06 - 1: Function block parameters: Stop parallel pump operation in case of deviation / 0 to 10 min (10 min) Flow limit temp. parallel pump operation / 20.0 to 90.0 °C (40.0 °C) CO4 -> F06 - 0: UP1 switched off during DHW heating
07	Intermediate heating	1	2.x, 4.1, 4.5	CO4 -> F07 - 1: After 20 minutes of DHW heating, heating operation in UP1 circuit reactivated for 10 minutes CO4 -> F07 - 0: Storage tank charging is given unlimited priority over heating operation in UP1 circuit
08	Priority through reverse control	0	1.1–1.3, 4.1, 4.5, 11.x	CO4 -> F08 - 1: Only with CO4 -> F09 - 0 Function block parameters: Activate priority in case of deviation / 2 to 10 min (2 min) KP (influencing factor) / 0.1 to 10.0 (1.0)

F	Function	WE	Anl	Comment Function block parameters / Range of values (default)
09	Priority through set-back operation	0	1.1–1.3, 4.1, 4.5, 11.x	CO4 -> F09 - 1: Only with CO4 -> F08 - 0 Function block parameter: Activate priority in case of deviation / 2 to 10 min (2 min)
10	Circulation pump integrated into heat exchanger	0	1.6, 11.2	CO4 -> F10 - 1: Control of DHW circuit active while circulation pump ZP is operated
11	Operation of circulation pump during storage tank charging	0	1.1–1.3, 1.5, 1.6, 2.x, 4.1, 4.5, 11.1, 11.2	CO4 -> F11 - 1: Circulation pump (ZP) operates according to time schedule during storage tank charging CO4 -> F11 - 0: ZP switched off during storage tank charging
12	Control mode	1	1.9, 11.x	CO4 -> F12 - 1: Three-step control Function block parameters: KP (proportional gain) / 0.1 to 50.0 (2.0; Anl. x.9: 0.6) Tn (reset time) / 1 to 999 s (120 s; Anl. x.9: 12 s) TV (derivative-action time) / 0 s; Do not change! TY (valve transit time) / 5, 10, 15, ..., 240 s (45 s; Anl. x.9: 20 s) CO4 -> F12 - 0 (only in Anl. 11.0, 11.1): On/off control Function block parameters: Hysteresis / 1.0 to 30.0 °C (5.0 °C) Min. ON time / 0 to 10 min (2 min) Min. OFF time / 0 to 10 min (2 min)
13	Limit deviation for OPEN signal	0	1.9, 11.x	CO4 -> F13 - 1: Only with CO4 -> F12 - 1 Function block parameter: Max. deviation / 2.0 to 10.0 °C (2.0 °C)
14	Thermal disinfection	0	All*	CO4 -> F14 - 1: Only with CO4 -> F01 - 1 Function block parameters: Day of the week / 1, 2, ..., 7, 1–7 (3) Start time / 00:00 to 23:45 (00:00) Stop time / 00:00 to 23:45 (04:00) Disinfection temperature / 60.0 to 90.0 °C (70.0 °C) Set point boost / 0 to 50 °C (10 °C) Hold time of disinfection temperature / 0 to 255 min (0 min) With setting Start time = Stop time Select: bE= 1, bE=0 (bE= 1), input terminals 03/12 (only possible without SF2/RF2)

F	Function	WE	Anl	Comment Function block parameters / Range of values (default)
15	SLP ON depending on return flow temperature	0	1.5, 1.6, 2.1, 2.3, 4.1	CO4 -> F15 - 1: Only with CO1 -> F03 - 1
16	Priority for external demand	0	1.5, 1.6, 2.x, 4.1	With CO4 -> F16 - 1, a high external demand causes excessive charging temperatures in DHW circuits without control valve
19	Time-controlled switchover of storage tank sensors	0	1.1–1.3, 1.5, 1.6, 2.x, 4.1, 4.5, 11.1, 11.2	CO4 -> F19 - 1: Only with CO4 -> F02 - 1 SF1 for day mode and SF2 for night mode.
20	DHW circuit additionally controlled by a globe valve	0	11.1	CO4 -> F20 - 1: Return flow temperature limitation over a globe valve with VF2 in the heating register return pipe of the storage tank.

F Function block number, WE Default value, Anl System code number

CO5: System-wide functions (all systems)

If CO5 -> F00 - 1 is indicated, access to the return flow, flow rate and heat capacity settings are locked.

F	Function	WE	Anl	Comment Function block parameters / Range of values (default)
01	Sensor initialization	1	All	Irrelevant of the function block setting: Pt 1000
02				
03				
04	Summer mode	0	Not Anl 1.5, 1.6, 1.9, 3.5	CO5 -> F04 - 1: Activation of time-controlled summer mode Function block parameters: Start summer mode / 01.01 to 31.12 (01.06) No. of days until activation / 1 to 3 (2) Stop summer mode / 01.01 to 31.12 (30.09) No. of days until deactivation / 1 to 3 (1) Outdoor temperature limit for summer mode / 0.0 to 30.0 °C (18.0 °C)
05	Delayed outdoor temperature adaptation when temperature decreases	0	Not Anl 1.9	CO5 -> F05, 06 - 1: Function block parameter: Delay per hour/ 1.0 to 6.0 °C (3.0 °C)
06	Delayed outdoor temperature adaptation when temperature increases	0	Not Anl 1.9	
07	Reserved			
08	Automatic summer time/winter time changeover	1	All	
09	Frost protection program II	1	Not Anl 1.5, 1.6, 1.9, 3.5	CO5 -> F09 - 0: Frost protection program I (restricted frost protection) Function block parameter: Frost protection limit / -15.0 to 3.0 °C (3.0 °C)
		0	1.5, 1.6, 1.9, 3.5	CO5 -> F09 - 1: Frost protection program II Function block parameter: Frost protection limit / -15.0 to 3.0 °C (3.0 °C)
10	Reserved			

F	Function	WE	Anl	Comment Function block parameters / Range of values (default)
11	Reserved			
12	Creep feed rate limitation	0	Not Anl 1.9	CO5 -> F12 - 1: Creep feed rate limitation, Input over terminals 04/12 Function block parameter: bE=1, bE=0 (bE=1)
13	Reserved			
14	UP1 operation to cover own demand	0	Anl 3.0	CO5 -> F14 - 1: Feeder pump UP1 also starts to cover demand of control circuit Rk2.
15	Release controller at BE1	0	All	CO5 -> F15 - 1: FG1 has no function Select bE= 1, bE=0 (bE=1)
16	Return flow temperature limitation with P algorithm	0	All	CO5 -> F16 - 1: Return flow temperature limitation with P-action only
17	Reserved			
18	Reserved			
19	Temperature monitoring	0	All	CO5 -> F19 - 1: Temperature monitoring active
20	Sensor calibration	1	All	CO5 -> F20 - 1: Adjusting all sensor calibration values CO5 -> F20 - 0: Deleting all adjusted sensor calibration values
21	Locking manual level	0	All	CO5 -> F21 - 1: In switch position  , automatic mode applies
22	Locking the rotary switch	0	All	CO5 -> F22 - 1: Rotary switch without function – Access after entering key number still possible.
23	Outdoor temperature received over 0 to 10 V input	0	All	CO5 -> F23 - 1: Outdoor temperature received over 0 to 10 V input Function block parameters: Lower transmission range / -30 to 100 °C (-20 °C) Upper transmission range / -30 to 100 °C (50 °C)
				*Not in systems Anl 1.0, 1.5, 1.6, 3.0, 3.5, 4.0, 11.x

F Function block number, WE Default value, Anl System code number

CO6: Modbus (all systems)

F	Function	WE	Anl	Comment
				Function block parameters / Range of values (default)
01	Modbus	1	All	CO6 -> F01 - 1: Modbus active
02	Modbus 16-bit addressing	0	All	CO6 -> F02 - 1: 16-bit addressing, only with CO6 -> F01 - 1 CO6 -> F02 - 0: 8-bit addressing
03	Modem function	0	All	CO6 -> F03 - 1 Only with <ul style="list-style-type: none"> • CO6 -> F01 - 1 • CO6 -> F08 - 1
04	Automatic modem configuration	0	All	CO6 -> F04 - 1 Only with <ul style="list-style-type: none"> • CO6 -> F03 - 1 • CO6 -> F08 - 1
05	Lock dial-up	0	All	CO6 -> F05 - 1: No dial-up to GLT in case of error, only with CO6 -> F03 - 1
06	Dial-up also upon corrected error	0	All	CO6 -> F06 - 1: Dial-up to GLT also to indicate that an error has been corrected, only with CO6 -> F03 - 1
07	Control system monitoring	0	All	CO6 -> F07 - 1: Resetting all level bits to "autonomous" when there is no communication, only with CO6 -> F01 - 1
08	Text message	0	All	CO6 -> F08 - 1: Sending of text message active

F Function block number, WE Default value, Anl System code number

12.2 Parameter lists

PA1: Parameters Rk1 (heating circuit 1)

PA2: Parameters Rk2 (heating circuit 2)

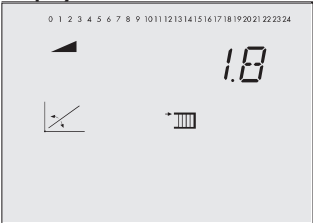
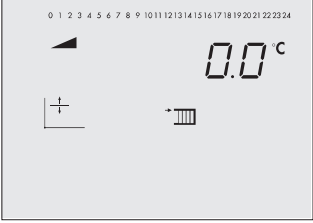
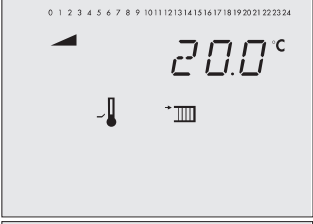
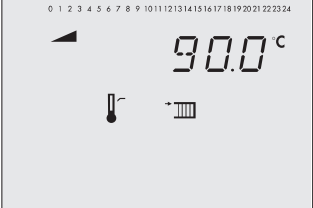
Display	Parameter designation Range of values (default)
 <p>The display shows a digital readout of '1.8'. To the left is a graph icon with a line sloping upwards. Below the graph is a valve icon with a plus sign. Above the display is a row of numbers from 0 to 24.</p>	<p>Gradient, flow</p> <p>0.2 to 3.2 (1.8) (with CO1, 2 -> F05 - 1: 0.2 to 1.0 (1.0) applies)</p>
 <p>The display shows a digital readout of '0.0 °C'. To the left is a graph icon with a horizontal line. Below the graph is a valve icon with a plus sign. Above the display is a row of numbers from 0 to 24.</p>	<p>Level (parallel shift)</p> <p>-30.0 to 30.0 °C (0.0 °C)</p>
 <p>The display shows a digital readout of '20.0 °C'. To the left is a graph icon with a horizontal line. Below the graph is a valve icon with a thermometer symbol. Above the display is a row of numbers from 0 to 24.</p>	<p>Min. flow temperature</p> <p>5.0 to 130.0 °C (20.0 °C)</p>
 <p>The display shows a digital readout of '90.0 °C'. To the left is a graph icon with a horizontal line. Below the graph is a valve icon with a thermometer symbol. Above the display is a row of numbers from 0 to 24.</p>	<p>Max. flow temperature</p> <p>5.0 to 130.0 °C (90.0 °C) (with CO1, 2, 3 -> F05 - 1: 5.0 to 50.0 °C (50.0 °C) applies)</p>

Display

Parameter designation

Range of values (default)

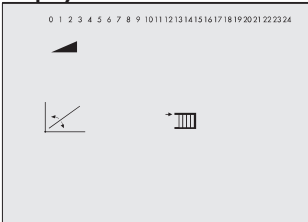

4-point characteristic

Press rotary pushbutton (✱) to set the following parameters:
 outdoor temperature,
 flow temperature,
 reduced flow temperature and
 return flow temperature

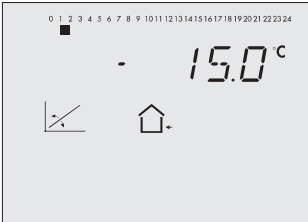

4-point characteristic

Point 1: Outdoor temperature

Outdoor temperatures of the points 2, 3, 4 are marked by squares below the numbers 2, 3, 4.
 -30.0 to 50.0 °C
 (point 1: -15.0 °C, point 2: -5.0 °C, point 3: 5.0 °C,
 point 4: 15.0 °C)

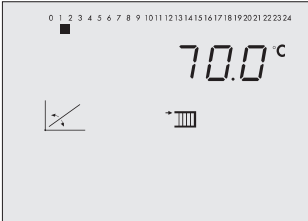

4-point characteristic

Point 1: Flow temperature

Flow temperatures of the points 2, 3, 4 are marked by squares below the numbers 2, 3, 4.
 5.0 to 130.0 °C
 (point 1: 70.0 °C, point 2: 55.0 °C, point 3: 40.0 °C,
 point 4: 25.0 °C)

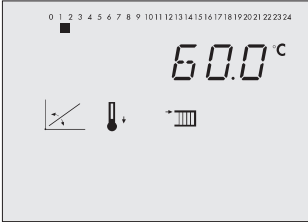

4-point characteristic

Point 1: Reduced flow temperature

Reduced flow temperatures of the points 2, 3, 4 are marked by squares below the numbers 2, 3, 4.
 5.0 to 130.0 °C
 (point 1: 60.0 °C, point 2: 40.0 °C, point 3: 20.0 °C,
 point 4: 20.0 °C)

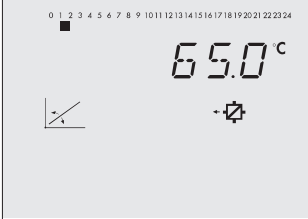

4-point characteristic

Point 1: Return flow temperature

Return flow temperatures of the points 2, 3, 4 are marked by squares below the numbers 2, 3, 4.
 5.0 to 90.0 °C
 (points 1 to 4: 65.0 °C)

Display

Parameter designation
 Range of values (default)

OT deactivation value in rated operation

0.0 to 50.0 °C (22.0 °C)

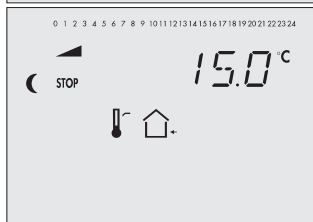

OT deactivation value in reduced operation

-20.0 to 50.0 °C (15.0 °C)

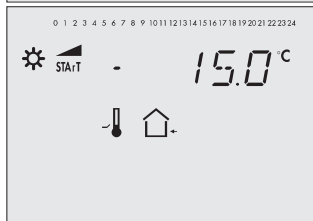

OT activation value in rated operation

-20.0 to 5.0 °C (-15.0 °C)

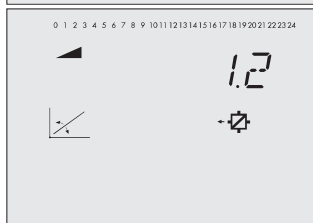

Gradient, return flow

0.2 to 3.2 (1.2)

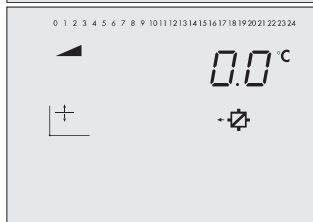

Level, return flow

-30.0 to 30.0 °C (0.0 °C)

Display

Parameter designation

Range of values (default)

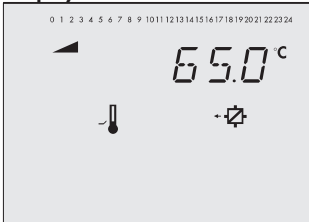

Return flow temperature foot

5.0 to 90.0 °C (65.0 °C)



Max. return flow temperature

5.0 to 90.0 °C (65.0 °C)

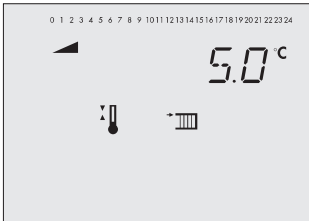

Set point boost of primary exchanger control

0.0 to 50.0 °C (5.0 °C)

Only in PA1 parameter level



Set point for binary demand processing

5.0 to 130.0 °C (40.0 °C)

Only in PA1 parameter level

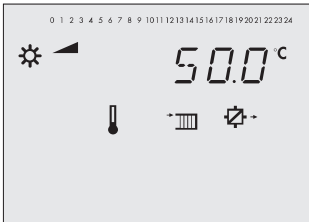

Day set point for flow temperature

5.0 to 130.0 °C (50.0 °C)

Only for flash adaptation without outdoor sensor

Display

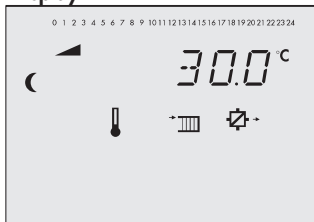

Parameter designation

Range of values (default)

Night set point for flow temperature

5.0 to 130.0 °C (30.0 °C)

Only for flash adaptation without outdoor sensor

PA4: DHW circuit parameters

Display

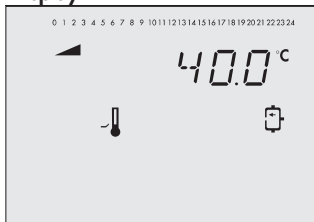

Parameter designation

Range of values (default)

Min. DHW temperature

5.0 to 90.0 °C (40.0 °C)

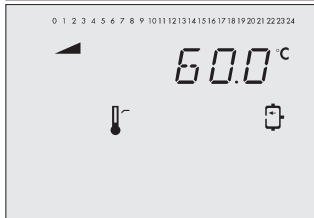

Max. DHW temperature

5.0 to 90.0 °C (60.0 °C)

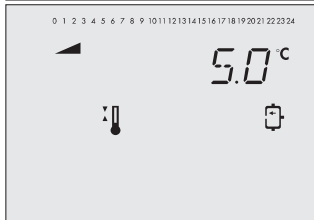

Hysteresis

1.0 to 30.0 °C (5.0 °C)

Display

Parameter designation

Range of values (default)

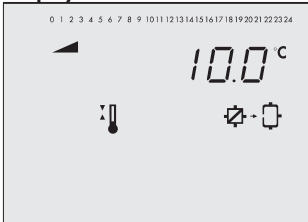

Charging temperature boost

0.0 to 50.0 °C (10.0 °C)

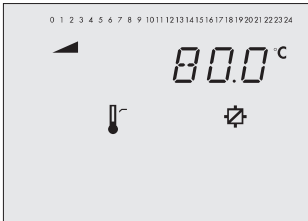

Max. charging temperature (only with VF4)

20.0 to 130.0 °C (80.0 °C)

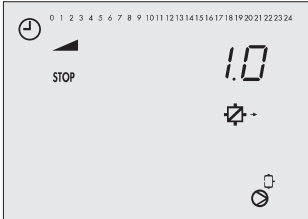

Lag of storage tank charging pump

0.0 to 10.0 (1.0)

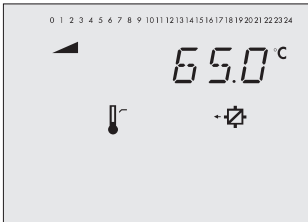

Max. return flow temperature

20.0 to 90.0 °C (65.0 °C)

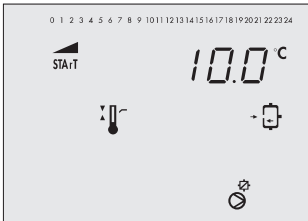

Solar pump ON

1.0 to 30.0 °C (10.0 °C)

Display

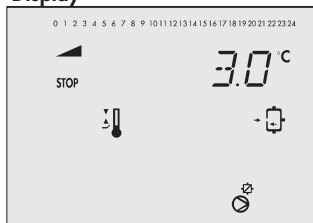
Parameter designation
 Range of values (default)

Solar pump OFF
 0.0 to 30.0 °C (3.0 °C)

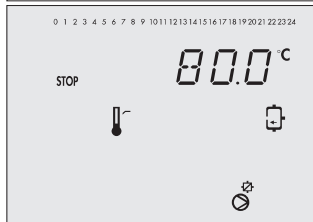

Max. storage tank temperature
 20.0 to 90.0 °C (80.0 °C)

PA5: System-wide parameters (all systems)

Display

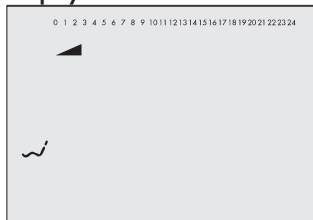
Parameter designation

Public holidays
 (01.01 to 31.12 -> section 1.8.1)

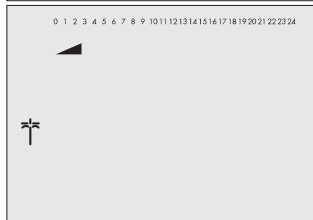

Vacation periods
 (01.01 to 31.12 -> section 1.8.2)

PA6: Modbus parameters

Display

Parameter designation Range of values (default)

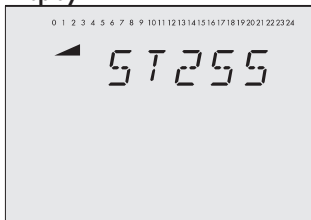

Station address (ST)

1 to 247 (255)
(with CO6 -> F02 - 1: 1 to 32000 applies)

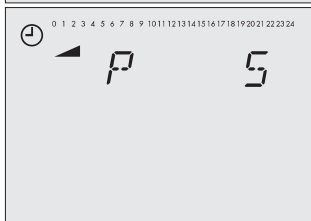

Modem dialing pause (P)

0 to 255 min (5 min)

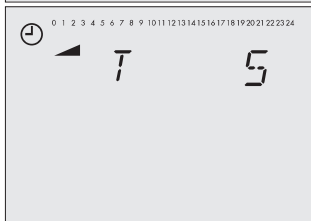

Modem time-out (T)

1 to 255 min (5 min)

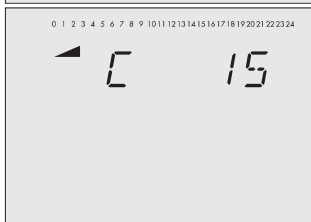

Number of redialing attempts to building control station (C)

1 to 255 (15)

Display

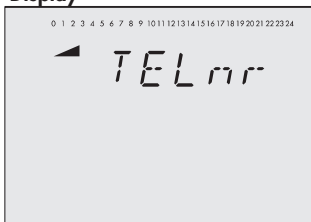
Parameter designation
 Range of values (default)

Phone number of control station (TELnr)

Max. 22 characters; 1, 2, 3, ..., 9, 0;
 "-" = end of a string
 "P" = pause

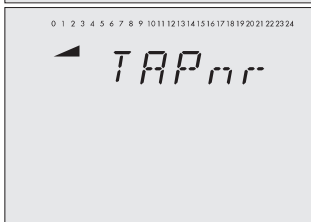

Access number (TAPnr)

Max. 22 characters; 1, 2, 3, ..., 9, 0;
 "-" = end of a string
 "P" = pause

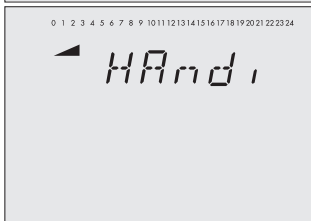

Mobile phone number (HAndi)

Max. 22 characters; 1, 2, 3, ..., 9, 0;
 "-" = end of a string
 "P" = pause

12.3 Sensor resistance tables

Resistance values with Pt 1000 resistors

Type 5227-2 Outdoor Temperature Sensor, Type 5277-2 Flow, Return Flow and Storage Tank Temperature Sensor (thermowell required) and Type 5267-2 (contact sensor) Flow, Return Flow and Storage Tank Temperature Sensor.

Type 5257-1, Type 5257-5 (room panel) Room Temperature Sensors.

°C	-35	-30	-25	-20	-15	-10	-5	0	5	10
Ω	862.5	882.2	901.9	921.6	941.2	960.9	980.4	1000.0	1019.5	1039.0
°C	15	20	25	30	35	40	45	50	55	60
Ω	1058.5	1077.9	1097.3	1116.7	1136.1	1155.4	1174.7	1194.0	1213.2	1232.4
°C	65	70	75	80	85	90	95	100	105	110
Ω	1251.6	1270.7	1289.8	1308.9	1328.0	1347.0	1366.0	1385.0	1403.9	1422.9
°C	115	120	125	130	135	140	145	150		
Ω	1441.7	1460.6	1479.4	1498.2	1517.0	1535.8	1554.5	1573.1		

12.4 Technical data

Inputs	8 inputs for Pt 1000 temperature sensors and 2 binary inputs, Input at terminal 11 for a 0 to 10 V demand signal from supplementary circuits (0 to 10 V correspond with 20 to 120 °C flow temperature)
Outputs*	2 x three-step signal: load max. 250 V AC, 2 A Alternatively 2 x on/off signal: load max. 250 V AC, 2 A 3 x pump output: load max. 250 V AC, 2 A all outputs as relay outputs with varistor suppressor Input at terminal 11 can alternatively be used as a 0 to 10 V output signal for continuous-action control circuit Rk1 or for demand signal, load > 5 k Ω
Optional interfaces	1 x Modbus RS-232 interface for modem using RS-232/modem communication module 1 x Modbus RS-485 interface for two-wire bus using RS-485 communication module (Modbus RTU protocol, data format 8N1, RJ-45 jack at the side)
Operating voltage	85 to 250 V, 48 to 62 Hz, max. 1.5 VA
Ambient temperature	0 to 40 °C (operation), -10 °C to 60 °C (storage and transport)
Degree of protection	IP 40 according to IEC 529
Class of protection	II according to VDE 0106
Degree of contamination	2 according to VDE 0110
Overvoltage category	II according to VDE 0110
Humidity rating	F according to VDE 40040
Noise immunity	According to EN 61000-6-1
Noise emission	According to EN 61000-6-3
Weight	Approx. 0.5 kg

* A maximum of 4 pump outputs are available for systems with one control circuit.

12.5 Customer data

Station	
Operator	
SAMSON office	
System code number	

Function block settings in configuration levels

	CO 1	CO 2	CO 4	CO 5	CO 6
F01					
F02					
F03					
F04					
F05					
F06					
F07					
F08					
F09					
F10					
F11					
F12					
F13					
F14					
F15					
F16					
F17					
F18					
F19					
F20					
F21					
F22					
F23					

Rk1 (heating circuit 1) and Rk2 (heating circuit 2)

Parameters in levels 1 and 2	PA1	PA2	Range of values
Gradient, flow			0.2 to 3.2
Level, flow			-30.0 to 30.0 °C
Min. flow temperature			5.0 to 130.0 °C
Max. flow temperature			5.0 to 130.0 °C
4-point characteristic			
Outdoor temperature; point 1			-30.0 to 50.0 °C
Outdoor temperature; point 2			-30.0 to 50.0 °C
Outdoor temperature; point 3			-30.0 to 50.0 °C
Outdoor temperature; point 4			-30.0 to 50.0 °C
Flow temperature; point 1			5.0 to 130.0 °C
Flow temperature; point 2			5.0 to 130.0 °C
Flow temperature; point 3			5.0 to 130.0 °C
Flow temperature; point 4			5.0 to 130.0 °C
Reduced flow temperature; point 1			5.0 to 130.0 °C
Reduced flow temperature; point 2			5.0 to 130.0 °C
Reduced flow temperature; point 3			5.0 to 130.0 °C
Reduced flow temperature; point 4			5.0 to 130.0 °C
Return flow temperature; point 1			5.0 to 90.0 °C
Return flow temperature; point 2			5.0 to 90.0 °C
Return flow temperature; point 3			5.0 to 90.0 °C
Return flow temperature; point 4			5.0 to 90.0 °C
OT deactivation value in rated operation			0.0 to 50.0 °C
OT deactivation value in reduced operation			-20.0 to 50.0 °C
OT activation value in rated operation			-20.0 to 5.0 °C
Gradient, return flow			0.2 to 3.2
Level, return flow			-30.0 to 30.0 °C
Return flow temperature foot			5.0 to 90.0 °C
Max. return flow temperature			5.0 to 90.0 °C

Parameters	PA1	PA2	Range of values
Day set point for flow temperature			5.0 to 130.0 °C
Night set point for flow temperature			5.0 to 130.0 °C
Set point boost of primary heat exchanger control			0.0 to 50.0 °C
Set point for binary demand processing			5.0 to 130.0 °C
Function block parameters	CO1	CO2	Range of values
F03 - 1: KP (limiting factor)			0.1 to 10.0
F05 - 1: Start temperature			20 to 60 °C
F05 - 1: Temperature rise per day			1.0 to 10.0 °C
F05 - 1: Maximum temperature			25.0 to 60.0 °C
F05 - 1: Maintaining time of max. temp.			0 to 10 days
F05 - 1: Temperature reduction per day			0.0 to 10.0 °C
F09 - 1: Cycle time			0/1 to 100 min
F09 - 1: KP (gain)			0.0 to 25.0
F12 - 1: KP (proportional gain)			0.1 to 50.0
F12 - 1: Tn (reset time)			1 to 999 s
F12 - 1: TV (derivative-action time)			0 to 999 s
F12 - 1: TY (valve transit time)			5 to 240 s
F12 - 0: Hysteresis			1.0 to 30.0 °C
F12 - 0: Min. ON time			0 to 10 min
F12 - 0: Min. OFF time			0 to 10 min
F13 - 1: Max. deviation			2.0 to 10.0 °C
F14 - 1: Binary input			bE=1, bE=0
F17 - 1: Binary input			bE=1, bE=0
F18 - 1: Lower transmission range			0.0 to 130.0 °C
F18 - 1: Upper transmission range			0.0 to 130.0 °C

Parameters in PA4 level: DHW heating

Parameters	PA4	Range of values
Min. DHW temperature		5.0 to 90.0 °C
Max. DHW temperature		5.0 to 90.0 °C
Hysteresis		1.0 to 30.0 °C
Charging temperature boost		0.0 to 50.0 °C
Max. charging temperature		20.0 to 130.0 °C
Lag of storage tank charging pump		0.0 to 10.0
Max. return flow temperature		0.0 to 90.0 °C
Solar pump ON		1.0 to 30.0 °C
Solar pump OFF		0.0 to 30.0 °C
Max. storage tank temperature		20.0 to 90.0 °C
Function block parameters	CO4	Range of values
F03 - 1: KP (limiting factor)		0.1 to 10.0
F06 - 1: Stop parallel operation in case of deviation		0 to 10 min
F06 - 1: Flow limit temp. for parallel pump operation		20.0 to 90.0 °C
F08 - 1: Activate priority in case of deviation		2 to 10 min
F08 - 1: KP (Einflussfaktor)		0.1 to 10.0
F09 - 1: Activate priority in case of deviation		2 to 10 min
F12 - 1: KP (proportional gain)		0.1 to 50.0
F12 - 1: Tn (reset time)		1 to 999 s
F12 - 1: TV (derivative-action time)		0 s; Do not change!
F12 - 1: TY (valve transit time)		5 to 240 s
F12 - 0: Hysteresis		1.0 to 30.0 °C
F12 - 0: Min. ON time		0 to 10 min
F12 - 0: Min. OFF time		0 to 10 min
F13 - 1: Max. deviation		2.0 to 10.0 °C
F14 - 1: Day of the week		1-7, 1 to 7
F14 - 1: Start time		00:00 to 23:45h
F14 - 1: Stop time		00:00 to 23:45h
F14 - 1: Disinfection temperature set point		60.0 to 90.0 °C
F14 - 1: Set point boost		0.0 to 50.0 °C
F14 - 1: Hold time of disinfection temperature		0 to 255 min

Parameters in PA5 level



Parameters	PA5					Range of values
Public holidays						01.01 to 31.12
Vacation periods, start						01.01 to 31.12
Vacation periods, stop						
Assignment to control circuit						1, 2, 3
Vacation periods, start						01.01 to 31.12
Vacation periods, stop						
Assignment to control circuit						1, 2, 3
Function block parameters	CO5					Range of values
F04 - 1: Start summer mode						01.01 to 31.12
F04 - 1: No. of days until activation						1 to 3
F04 - 1: Stop summer mode						01.01 to 31.12
F04 - 1: No. of days until deactivation						1 to 3
F04 - 1: Outdoor temperature limit						0.0 to 30.0 °C
F05/6 - 1: Delay per hour						1.0 to 6.0 °C
F09 - 0/- 1: Frost protection limit						-15.0 to 3.0 °C
F12-1: Binary input						bE=1, bE=0
F15-1: Binary input						bE=1, bE=0
F23 - 1: Lower transmission range						-30 to 100 °C
F23 - 1: Upper transmission range						-30 to 100 °C

Parameters in PA6 level



Parameters	PA6	Range of values
Station address (ST)		1 to 247 1 to 32000
Modem dialing pause (P)		0 to 255 min
Modem time-out (T)		1 to 255 min
Number of redialing attempts (C)		1 to 255
Phone no. of control station (TELn _r)		-
Access number (TAPn _r)		-
Mobile phone number (HAndi)		-

Settings at the rotary switch



Heating circuit 1 · Display: 1

Parameters								Range of values
 Day set point								0.0 to 40.0 °C 5.0 to 130.0 °C
 Night set point								0.0 to 40.0 °C 5.0 to 130.0 °C
 Times-of-use	Mon	Tue	Wed	Thu	Fri	Sat	Sun	
Start of first time-of-use								
End of first time-of-use								
Start of second time-of-use								
End of second time-of-use								
Start of third time-of-use								
End of third time-of-use								

Heating circuit 2 · Display: 2

Parameters								Range of values
 Day set point								0.0 to 40.0 °C 5.0 to 130.0 °C
 Night set point								0.0 to 40.0 °C 5.0 to 130.0 °C
 Times-of-use	Mon	Tue	Wed	Thu	Fri	Sat	Sun	
Start of first time-of-use								
End of first time-of-use								
Start of second time-of-use								
End of second time-of-use								
Start of third time-of-use								
End of third time-of-use								

DHW circuit · Display: 3

Parameters		Range of values						
 DHW temperature set point		40.0 to 60.0 °C						
 Sustained DHW temperature		40.0 to 60.0 °C						
☀️ Times-of-use for DHW heating								
	Mon	Tue	Wed	Thu	Fri	Sat	Sun	
Start of first time-of-use								
End of first time-of-use								
Start of second time-of-use								
End of second time-of-use								
Start of third time-of-use								
End of third time-of-use								
☀️ Times-of-use for circulation pump								
	Mon	Tue	Wed	Thu	Fri	Sat	Sun	
Start of first time-of-use								
End of first time-of-use								
Start of second time-of-use								
End of second time-of-use								
Start of third time-of-use								
End of third time-of-use								

Index

- 4-point characteristic 49
- A**
- Adaptation 58
- Automatic mode. 7
- B**
- Boiler circuits 28
- C**
- Characteristic. 46
- Circulation pump 65
- Communication parameters 85
- Communications module
 - RS-232/modem 83
 - RS-485 84
- Condensate accumulation control 72
- Configuration level 93, 102
- Connection
 - Actuator. 91
 - Controller. 90
 - Pump 91
 - Sensor 91
- Continuous control 73
- Control
 - continuous 73
 - on/off 73
 - three-step. 73
- Control station, phone number 85
- Control system monitoring. 84
- Controller ID 14, 81
- Controller time 10
- Creep feed rate limitation 76
- Customer data 114, 120
- Cyclical initialization 85
- D**
- Data logging 86
- Data logging module 14, 86
- Day mode 7
- Day set point 48
- Default settings. 25
- Delayed outdoor temperature adaptation . 54
- Demand processing
 - external 75
- DHW heating
 - additionally controlled by a globe valve 61
 - in instantaneous heating system 64
 - in solar system 65
 - in storage tank charging system. 62
 - in storage tank system. 59
 - time-controlled switchover of storage tank sensors 60, 63
- Disinfection temperature not reached. . . . 68
- Drying of jointless floors 51
- E**
- Electrical connection 90 - 92
- Error messages
 - confirming error messages 78
- Error status register 79
- Extended information level 14
- External demand processing 75
 - 0 to 10 V signal 75
 - binary signal 75
- F**
- Feeder pump 77
- Fixed set point control. 50
- Flash adaptation
 - outdoor temperature dependent. 56
 - room temperature dependent. 57
- Forced charging, DHW storage tank 67
- Forced operation, pumps 71
- Frost protection 70
- Function block lists 93, 102
- Function block number 21
- Functions, activating and deactivating . . . 21

G		Night set point	48
Gradient characteristic	46 - 47	O	
H		On/off control	73
Heating characteristic	46	Operating controls	6
I		Operating modes	7
Information level	9	Operational faults	78 - 81
extended	14	Optimization	55
Installation		Outdoor temperature adaptation, delayed	54
Panel mounting	88	Outdoor temperature, deactivation	52
Top hat rail mounting	88	Overvoltage protection	90
Wall mounting	88	P	
Intermediate heating operation	65	Parallel operation, pumps	65
J		Parameter lists	103, 111
Jointless floors, drying	51	Parameters, changing	23
K		Party mode	13
Key number	20	Primary system	27
Key number, customized	77	Priority	
L		DHW heating	66
Level structure	19	Priority operation	66
Locking		Public holidays	15
Manual level	76	Pumps, forced operation	71
Rotary switch	77	Pumps, switching to manual mode	26
M		R	
Manual level	6	Rated operation	7
locking	76	Reduced operation	7
Manual mode	7, 26	Release control circuit	
Memory module	86	over the binary input	74
Modem dialing pause	85	Remote operation	54
Modem redialing attempts, number of	85	Resistance values	112
Modem time-out	85	Return flow temperature limitation	71
N		Reverse control	66
Network structure	82	Room Panel (Pt 1000 sensor)	54
Night mode	7	Rotary pushbutton	6
		Rotary switch	6
		locking	77
		RS-232	83
		RS-485	84

S

Secondary system	27
Sensor calibration	24
Sensor failure	79
Set point	
day	18, 48
DHW temperature	18
night	18, 48
Set-back operation	67
Stand-by mode	7
Start-up	20 - 25
Station address	85
Steam pressure control	71
Summer mode	53
Summer time/winter time changeover	70
Sustained DHW temperature	18, 60, 63 - 64
Switching states of binary inputs	14
System code number	20
Systems	27 - 45

T

Technical data	113
Temperature monitoring	79
Temperature monitoring alarm	79
Text message in case of error	80
Thermal disinfection	68
Three-step control	73
Time-of-use	11
TROVIS-VIEW	86

U

Unauthorized access occurred	78, 80, 83
Underfloor heating	51

V

Vacation periods	16
Valve positions	14

W

Weather-compensated control	46
-----------------------------	----

Key number:

1732

Type 1

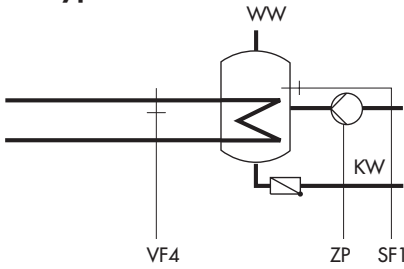

Type 2

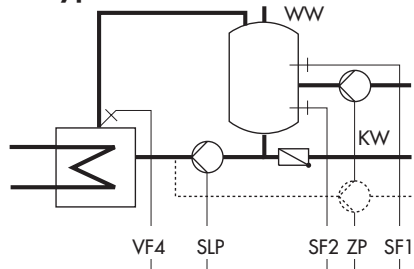

Type 3

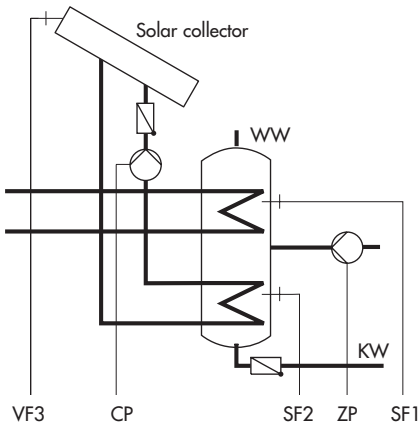

Key abbreviations

<i>AF</i>	Outdoor sensor	<i>Rk</i>	Control circuit
<i>AnI</i>	System	<i>RüF</i>	Return flow sensor
<i>AT</i>	Outdoor temperature	<i>SF</i>	Storage tank sensor
<i>BA</i>	Binary output	<i>SLP</i>	Storage tank charging pump
<i>BE</i>	Binary input	<i>t</i>	Time
<i>CO</i>	Configurations level	<i>T</i>	Temperature
<i>CP</i>	Solar circuit pump	<i>TLP</i>	Heat exchanger charging pump
<i>EB</i>	Mounting and operating instructions	<i>TWE</i>	DHW heating
<i>F</i>	Function block	<i>UP</i>	Circulation pump
<i>GLT</i>	Building control station	<i>VF</i>	Flow sensor
<i>KI</i>	Terminal	<i>WE</i>	Default setting
<i>KW</i>	Cold water	<i>WW</i>	Hot water
<i>PA</i>	Parameter level	<i>ZP</i>	Circulation pump
<i>RF</i>	Room sensor		



SAMSON AG · MESS- UND REGELTECHNIK
Weismüllerstraße 3 · 60314 Frankfurt am Main · Germany
Phone: + 49 69 4009-0 · Fax: + 49 69 4009-1507
Internet: <http://www.samson.de>

EB 5573 EN

2009-05