

MOUNTING AND OPERATING INSTRUCTIONS



EB 8497 EN

Translation of original instructions



Series 3797
TROVIS 3797 Smart Positioner (PROFINET®)

HV 02.00.00 · SV 02.02.xx

CE Ex
certified

Edition September 2025

Note on these mounting and operating instructions

These mounting and operating instructions assist you in mounting and operating the device safely. The instructions are binding for handling SAMSON devices. The images shown in these instructions are for illustration purposes only. The actual product may vary.

- For the safe and proper use of these instructions, read them carefully and keep them for later reference.
- If you have any questions about these instructions, contact SAMSON's After-sales Service (aftersaleservice@samsongroup.com).



Documents relating to the device, such as the mounting and operating instructions, are available on our website at www.samsongroup.com > **Downloads > Documentation.**

Definition of signal words

DANGER

Hazardous situations which, if not avoided, will result in death or serious injury

WARNING

Hazardous situations which, if not avoided, could result in death or serious injury

NOTICE

Property damage message or malfunction

Note

Additional information

Tip

Recommended action

1	Safety instructions and measures	1-1
1.1	Notes on possible severe personal injury	1-4
1.2	Notes on possible personal injury	1-4
1.3	Notes on possible property damage	1-5
2	Markings on the device	2-1
2.1	Nameplate	2-1
2.1.1	Electronic module.....	2-2
2.2	Article code.....	2-3
2.3	Firmware versions	2-4
3	Design and principle of operation	3-1
3.1	Optional modules	3-3
3.1	Pneumatic modules	3-3
3.1.1	Option modules	3-6
3.2	Mounting versions.....	3-7
3.3	Configuration using the TROVIS-VIEW software	3-7
3.4	Technical data	3-8
3.5	Dimensions in mm.....	3-12
3.6	Fixing levels according to VDI/VDE 3845 (September 2010)	3-16
4	Shipment and on-site transport	4-1
4.1	Accepting the delivered goods	4-1
4.2	Removing the packaging from the positioner and pneumatic modules	4-1
4.3	Transporting the positioner and pneumatic modules.....	4-1
4.4	Storing the positioner and pneumatic modules.....	4-1
5	Installation	5-1
5.1	Installation conditions	5-1
5.2	Preparation for installation.....	5-2
5.2.1	Adjusting the lever and pin position.....	5-2
5.2.2	Checking the switch position for the dummy module	5-5
5.2.3	Installing and removing pneumatic modules	5-6
5.2.4	Installing and removing option modules	5-8
5.2.5	Preparing option modules for use	5-12
5.3	Positioner attachment	5-15
5.3.1	Mounting on Type 3277 Actuator.....	5-15
5.3.2	Attachment according to IEC 60534-6.....	5-18
5.3.3	Attachment according to VDI/VDE 3847	5-20
5.3.4	Attachment according to VDI/VDE 3845 and to Type 3278, VETEC S160 and R.....	5-31

Contents

5.4	Pneumatic connection	5-33
5.4.1	Signal pressure connection	5-34
5.4.2	Output pressure display	5-34
5.4.3	Supply pressure	5-34
5.4.4	Typical applications and hook-ups	5-35
5.5	Electrical connection	5-37
5.6	Mounting accessories	5-40
6	Operation	6-1
6.1	Rotary pushbutton	6-2
6.2	Initialization key (INIT)	6-2
6.3	Display	6-3
6.3.1	Menu structure	6-4
6.3.2	Display icons	6-6
6.3.3	Changing the reading direction of the display	6-7
6.4	PROFINET® communication	6-7
6.4.1	GSD files	6-8
6.5	First start-up	6-9
6.5.1	Start-up using Siemens PRONETA	6-10
6.6	Diagnostics	6-11
6.6.1	Profile diagnostic messages	6-11
6.6.2	Assignment of NAMUR status to READBACK STATUS	6-13
6.6.3	Alarms	6-14
6.7	Write protection	6-18
6.7.1	Write protection for bus communication	6-18
6.7.2	Write protection for on-site operation	6-19
6.7.3	Password configuration	6-19
7	Start-up and configuration	7-1
7.1	Enabling configuration	7-2
7.2	Setting start-up parameters	7-2
7.2.1	Actuator type	7-3
7.2.2	Operation with small actuators	7-3
7.2.3	Pin position	7-4
7.2.4	Nominal range	7-5
7.2.5	Initialization mode	7-5
7.2.6	Fail-safe action	7-9
7.2.7	Pneumatic primary output	7-9
7.2.8	Software restriction	7-9

7.3	Initializing the positioner	7-12
7.4	Configuring option modules	7-13
8	Operation	8-1
8.1	Changing operating mode	8-1
8.2	Performing zero calibration	8-2
8.3	Resetting the positioner	8-2
9	Malfunction	9-1
9.1	Troubleshooting	9-2
9.2	Emergency action	9-7
10	Servicing	10-1
10.1	Cleaning the cover window	10-1
10.2	Firmware updates	10-2
10.3	Periodic inspection and testing of the positioner	10-2
11	Decommissioning	11-1
12	Removal	12-1
13	Repairs	13-1
13.1	Returning devices to SAMSON	13-1
14	Disposal	14-1
15	Certificates	15-1
16	Appendix A (configuration instructions)	16-1
16.1	Operation at the device, using TROVIS-VIEW or DD and FDI packages	16-1
16.1.1	Main menu	16-1
16.1.1	Readable process data	16-32
16.1.2	Diagnosis/maintenance	16-35
16.1.3	Diagnosis: status messages	16-43
16.1.4	Reset functions	16-49
16.2	Operation using PROFINET®	16-50
16.2.1	Physical Block	16-50
16.2.2	Actuator Output Function Block	16-52
16.2.3	Actuator Transducer Block	16-54
16.3	Valve characteristic selection	16-56
17	Appendix B	17-1
17.1	After-sales service	17-1

1 Safety instructions and measures

Intended use

The SAMSON TROVIS 3797 Positioner is mounted on pneumatic control valves and used to assign the valve position to the control signal. The device can be upgraded by adding pneumatic modules and is designed to operate under exactly defined conditions (e.g. operating pressure, temperature). Therefore, operators must ensure that the positioner is only used in applications where the operating conditions correspond to the technical data. In case operators intend to use the positioner in applications or conditions other than those specified, contact SAMSON.

SAMSON does not assume any liability for damage resulting from the failure to use the device for its intended purpose or for damage caused by external forces or any other external factors.

➔ Refer to the technical data for limits and fields of application as well as possible uses.

Reasonably foreseeable misuse

The TROVIS 3797 Positioner is **not** suitable for the following applications:

- Use outside the limits defined during sizing and by the technical data

Furthermore, the following activities do not comply with the intended use:

- Use of non-original spare parts
- Performing maintenance activities not described in these instructions

Qualifications of operating personnel

The positioner must be mounted, started up and serviced by fully trained and qualified personnel only; the accepted industry codes and practices must be observed. According to these mounting and operating instructions, trained personnel refers to individuals who are able to judge the work they are assigned to and recognize possible hazards due to their specialized training, their knowledge and experience as well as their knowledge of the applicable standards.

Explosion-protected versions of this device must be operated only by personnel who has undergone special training or instructions or who is authorized to work on explosion-protected devices in hazardous areas.

Safety instructions and measures

Personal protective equipment

No personal protective equipment is required for the direct handling of the positioner. Work on the control valve may be necessary when mounting or removing the device.

- Observe the requirements for personal protective equipment specified in the valve documentation.
- Check with the plant operator for details on further protective equipment.

Revisions and other modifications

Revisions, conversions or other modifications of the product are not authorized by SAMSON. They are performed at the user's own risk and may lead to safety hazards, for example. Furthermore, the product may no longer meet the requirements for its intended use.

Safety features

Upon failure of the air supply, the positioner vents the actuator, causing the valve to move to the fail-safe position determined by the actuator. If a fail-in-place module is installed, it causes the pneumatic actuator to move to a position between the operating point and fail-safe position depending on the actuator size and the pressure range. As a result, emergency venting of the actuator is not guaranteed.

Upon failure of the electrical signal, the pneumatic outputs of the positioner are either vented or supplied with air. If a fail-in-place module is installed, it causes the pneumatic actuator to remain in its last position.

Warning against residual hazards

The positioner has direct influence on the control valve. To avoid personal injury or property damage, plant operators and operating personnel must prevent hazards that could be caused in the control valve by the process medium, the operating pressure, the signal pressure or by moving parts by taking appropriate precautions. Plant operators and operating personnel must observe all hazard statements, warnings and caution notes in these mounting and operating instructions, especially for installation, start-up and service work.

If inadmissible motions or forces are produced in the pneumatic actuator as a result of the supply pressure, it must be restricted using a suitable supply pressure reducing station.

Responsibilities of the operator

Operators are responsible for proper use and compliance with the safety regulations.

Operators are obliged to provide these mounting and operating instructions to the operating personnel and to instruct them in proper operation. Furthermore, operators must ensure that operating personnel or third parties are not exposed to any danger.

Responsibilities of operating personnel

Operating personnel must read and understand these mounting and operating instructions as well as the specified hazard statements, warnings and caution notes. Furthermore, operating personnel must be familiar with the applicable health, safety and accident prevention regulations and comply with them.

Servicing explosion-protected devices

If a part of the device on which the explosion protection is based needs to be serviced, the device must not be put back into operation until a qualified inspector has assessed it according to explosion protection requirements, has issued an inspection certificate or given the device a mark of conformity. Inspection by a qualified inspector is not required if the manufacturer performs a routine test on the device before putting it back into operation and the passing of the routine test is documented by attaching a mark of conformity to the device. Replace explosion-protected components only with original, routine-tested components by the manufacturer.

Devices that have already been operated outside hazardous areas and are intended for future use inside hazardous areas must comply with the safety requirements placed on serviced devices. Before being operated inside hazardous areas, test the devices according to the specifications for servicing explosion-protected devices.

Maintenance, calibration and work on equipment

- ➔ Only use intrinsically safe current/voltage calibrators and measuring instruments for interconnection with intrinsically safe circuits to check or calibrate the equipment inside or outside hazardous areas.
- ➔ Observe the maximum permissible values specified in the certificates for intrinsically safe circuits.

Referenced standards, directives and regulations

Devices with a CE marking fulfill the requirements of the following Directives:

TROVIS 3797: 2014/30/EU and 2011/65/EU

TROVIS 3797-110, -111: 2014/34/EU

The declarations of conformity are included in the 'Certificates' chapter.

Referenced documents

The following documents apply in addition to these mounting and operating instructions:

- Operating instructions for valve diagnostics: ► EB 8389-4
- The mounting and operating instructions of the components on which the positioner is mounted (valve, actuator, valve accessories etc.).

1.1 Notes on possible severe personal injury

DANGER

Risk of fatal injury due to the ignition of an explosive atmosphere.

Work performed incorrectly on the positioner in potentially explosive atmospheres may lead to ignition of the atmosphere and ultimately to death.

- Observe EN 60079-14 (VDE 0165, Part 1) for work on the positioner in potentially explosive atmospheres.
- Work in potentially explosive atmospheres is to be performed only by personnel who has undergone special training or instructions or who is authorized to work on explosion-protected devices in hazardous areas.

Risk of bursting in the pneumatic actuator due to the use of a fail-in-place module.

When a positioner with fail-in-place module is used, the pneumatic actuator may still be pressurized after the electric power or air supply is disconnected. Pneumatic actuators are pressure equipment that may burst when handled incorrectly. Flying projectile fragments or components can cause serious injury or even death.

Before working on the positioner, actuator or any other valve accessories:

- Depressurize all plant sections concerned and the actuator. Release any stored energy.

1.2 Notes on possible personal injury

WARNING

Crush hazard arising from actuator and plug stem moving.

The valve moves through its working range while the air supply is connected to the positioner.

- Do not insert hands or finger into the yoke while the air supply is connected to the positioner.
- Before working on the positioner, disconnect and lock the pneumatic air supply.
- Do not impede the movement of the actuator and plug stem by inserting objects into the yoke.

1.3 Notes on possible property damage

! NOTICE

Risk of damage to the positioner due to incorrect mounting position.

- Do not mount the positioner with the back of the device facing upward.
- Do not seal or restrict the vent opening when the device is installed on site.

An incorrect electric signal will damage the positioner.

The positioner is powered over the Ethernet-APL connection.

- Only use the two-wire Ethernet cable to power the positioner. Do not use any other current or voltage source.

Serious malfunction in the positioner due to the use of option modules intended for a different positioner model.

The TROVIS 3797 Positioner comes with slots designed to accommodate option modules (see Chapter 3.2.1). The functions of the option modules are not supported by the present firmware version. The use of option modules of a different positioner module (e.g. Z3799-x for the TROVIS 3793 Positioner) can lead to serious malfunction of the positioner.

- Do not remove dummy option modules and replace them with option modules.

Malfunction due to initialization not yet completed.

The initialization causes the positioner to be calibrated to adapt it to the mounting situation. After initialization is completed, the positioner is ready for use.

- Initialize the positioner on first start-up.
- Re-initialize positioner after changing the mounting position.
- Initialize positioner after replacing or adding pneumatic modules.

Risk of positioner damage due to incorrect grounding of the electric welding equipment.

- Do not ground electric welding equipment near the positioner.

Safety instructions and measures

Incorrect cleaning will damage the window.

The window is made of Makrolon® and will be damaged when cleaned with abrasive cleaning agents or agents containing solvents.

- Do not rub the window dry.
- Do not use any cleaning agents containing chlorine or alcohol or abrasive cleaning agents.
- Use a non-abrasive, soft cloth for cleaning.

2 Markings on the device

2.1 Nameplate

The nameplate shown was up to date at the time of publication of this document. The nameplate on the device may differ from the one shown.

Explosion-protected version

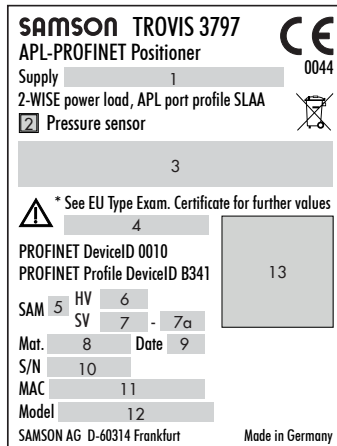

Pneumatic modules

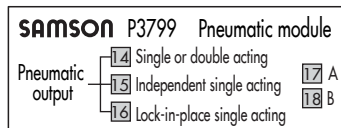

Option modules

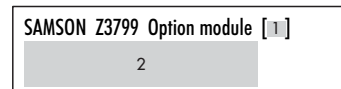

- 1 ID code of the option module
- 2 Function of the option module

Version without explosion protection

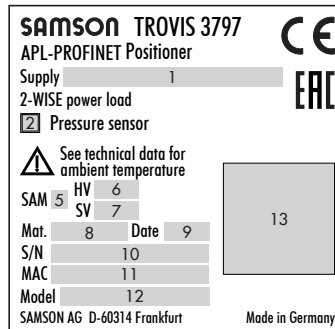

- 1 Supply pressure
- 2 Pressure sensor (yes/no)
- 3 Type of protection for explosion-protected devices
- 4 Temperature limits of test certificate for explosion-protected devices
- 5 Code for NAMUR Recommendation NE 53 (internal specification)
- 6 Hardware version
- 7 Software version
- 7a Compatibility of device version
- 8 Material number
- 9 Date of manufacture
- 11 Hardware address
- 12 Model number
- 13 DataMatrix code (electronic nameplate)
- 14 Single and double-acting pneumatic module (yes/no)
- 15 Pneumatic module with fail-in-position function (yes/no)
- 16 Pneumatic module with fail-in-position function (yes/no)
- 17 Slot A occupied (yes/no)
- 18 Slot B occupied (yes/no)

Markings on the device

2.1.1 Electronic module

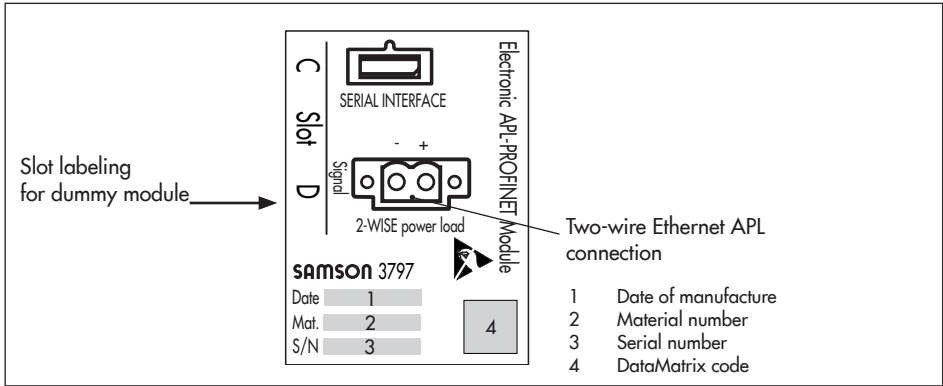

2.2 Article code

Positioner	TROVIS 3797- x x x 0 x x x x 0 0 x x x x x x 0 x 0 x 0 0 x x x x
With LCD, autotune, PROFINET® communication	
Explosion protection	
Without	0 0 0
ATEX II 2 G Ex ia IIC T4/T6 Gb	1 1 0
IECEX Ex ia IIC T4/T6 Gb	1 1 1
CCC Ex/NEPSI Ex ia IIC T4/T6 Gb	1 1 2
Pneumatics	
Single/double acting, k_{vS} 0.35	0 1
Single/double acting, k_{vS} 0.7	0 2
Single acting, 2x independent, k_{vS} 0.35	0 3
Fail-in-place module	2 0
Option module 1 (slot C)	
Without/dummy module	0 0
Option module 2 (slot D)	
Without/dummy module	0 0
Inductive limit contacts (NAMUR NC) + binary output (NAMUR), [P]; -50 to +85 °C	1 5
Pressure sensors	
Standard (Supply 9, Output 138, Output 238)	2
Electrical connection	
M20x1.5 (1x cable gland, 3x blanking plugs)	1
Housing material	
Aluminum (standard)	0
Stainless steel	1
Special applications	
Without	0
Prepared with adapter for VDI/VDE 3847	6
Additional certification	
Without	0
Permissible ambient temperature -40 to +85 °C (with metal cable gland) ¹⁾	1

Markings on the device

Positioner	TROVIS 3797- x x x 0 x x x x 0 0 x x x x x x 0 x 0 x 0 0 x x x x										
Display text in different languages											
Standard (English and German)	0										
Special version											
Without	0										
Cover without window	1										
Hardware version											
02.00.00								9	6		
Software version											
Standard ²⁾										0	0

¹⁾ For explosion-protected version, the following applies: -40 to +80 °C · The limits in the test certificate additionally apply.

²⁾ The standard software version is the latest software version (see Chapter 2.3)

2.3 Firmware versions

Firmware revisions	
Old	New
01.00.xx	02.00.xx
	Option modules and pneumatic module supported
	EXPERTplus diagnostic functions supported
	Actuators <350 cm ² supported
02.00.xx	02.01.07
	Software update over Ethernet possible
02.01.07	02.02.23
	Ethernet-APL-certified, certified according to PA Profile 4

3 Design and principle of operation

→ See Fig. 3-1

The TROVIS 3797 Electropneumatic Positioner is mounted on pneumatic control valves and used to assign the valve position (controlled variable x) to the control signal (set point w). The positioner compares the electric control signal issued by a control system using PROFINET over APL to the travel or opening angle of the control valve and issues a signal pressure for the pneumatic actuator. The positioner mainly consists of a non-contact travel sensor system (2), pneumatics and the electronics with the microcontroller (4). The output of the standard version is either single or double acting; which means both the Output 138 and Output 238 can provide the output variable and route the signal pressure to the actuator.

The positioner can be configured to meet requirements of an application by adding a pneumatic module. The pneumatic module mainly consists of a microcontroller, which operates an i/p converter with downstream spool valve. Depending on the actuator used, an output of the positioner can be sealed to achieve a single-acting function.

The valve position is transmitted either as an angle of rotation or linear travel to the pick-up lever, from there to the travel sensor (2) and forwarded to the microcontroller (4).

The PID algorithm in the microcontroller compares the valve position measured by the travel sensor (2) to the control signal issued by the control system. In case of a set point deviation, the pneumatic module (A, B) causes the actuator (1) to be either vented or supplied with air. As a result, the closure member of the valve (e.g. plug) is moved to the position determined by the set point.

The pneumatic module is supplied with air. The flow rate of the module's output can be restricted by software.

The positioner is operated by a rotary push-button (8) for menu navigation on the plain-text display (7).

The extended EXPERTplus diagnostics are integrated into the positioner. They provide information on the control valve and positioner and generate diagnostic and status messages, which allow faults to be pinpointed quickly.

Design and principle of operation

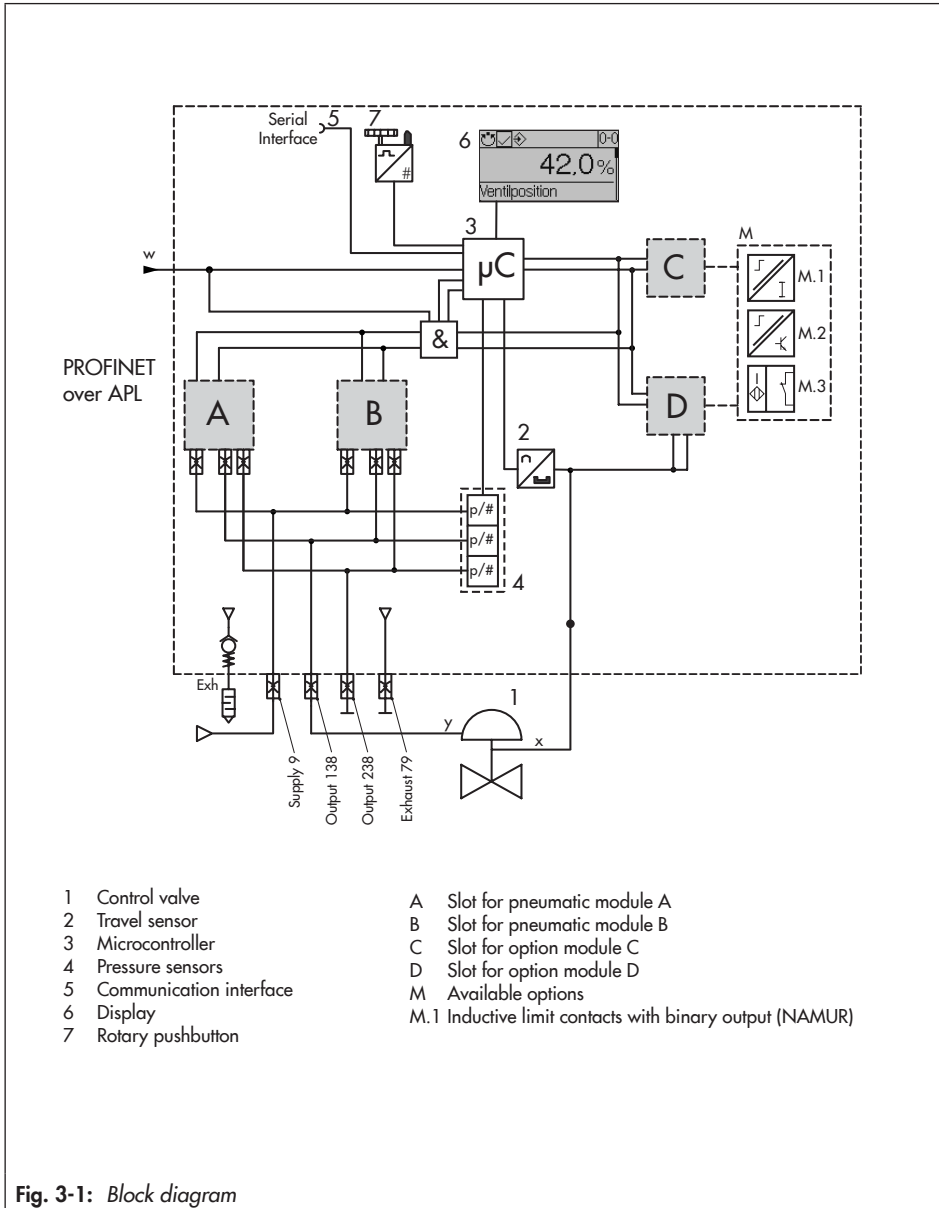

- | | | | |
|---|-------------------------|-----|---|
| 1 | Control valve | A | Slot for pneumatic module A |
| 2 | Travel sensor | B | Slot for pneumatic module B |
| 3 | Microcontroller | C | Slot for option module C |
| 4 | Pressure sensors | D | Slot for option module D |
| 5 | Communication interface | M | Available options |
| 6 | Display | M.1 | Inductive limit contacts with binary output (NAMUR) |
| 7 | Rotary pushbutton | | |

3.1 Optional modules

The modular design of the TROVIS 3797 Positioner allows it to be adapted to specific requirements:

- **Pneumatic modules** used to customize the air capacity, direction of action (single or double acting) and the fail-safe action upon power failure (see Table 3-1)

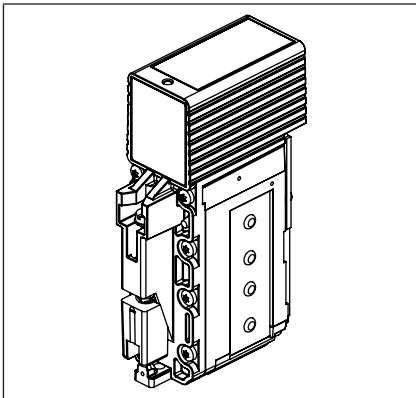

- **Option modules** to integrate additional functions

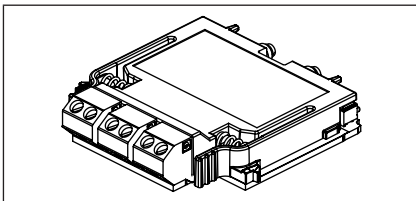

If the positioner is ordered with pneumatic modules and/or option modules, they are ready installed and connected upon delivery.

3.1 Pneumatic modules

The positioner is fitted with a pneumatic module and a dummy module in slots A and B.

Upon delivery, the positioner comes with the pneumatic module ready installed.

Table 3-1: Available pneumatic modules

Article code	Function of the pneumatic module
P3799-0000	Dummy module: it seals the slot connections and must be used when only one pneumatic module is installed.
P3799-0001	Output 138 and Output 238 modules: <ul style="list-style-type: none"> – Single and double acting – In the event of a power failure, the valve moves to its fail-safe position
P3799-0002	Output 138 module: <ul style="list-style-type: none"> – Single-acting – In the event of a power failure, the valve moves to its fail-safe position
P3799-0003	Output 238 module: <ul style="list-style-type: none"> – Single-acting – In the event of a power failure, the valve moves to its fail-safe position
P3799-0004	Output 138 module: fail-in-place function: the valve remains in its last position upon power failure

Design and principle of operation

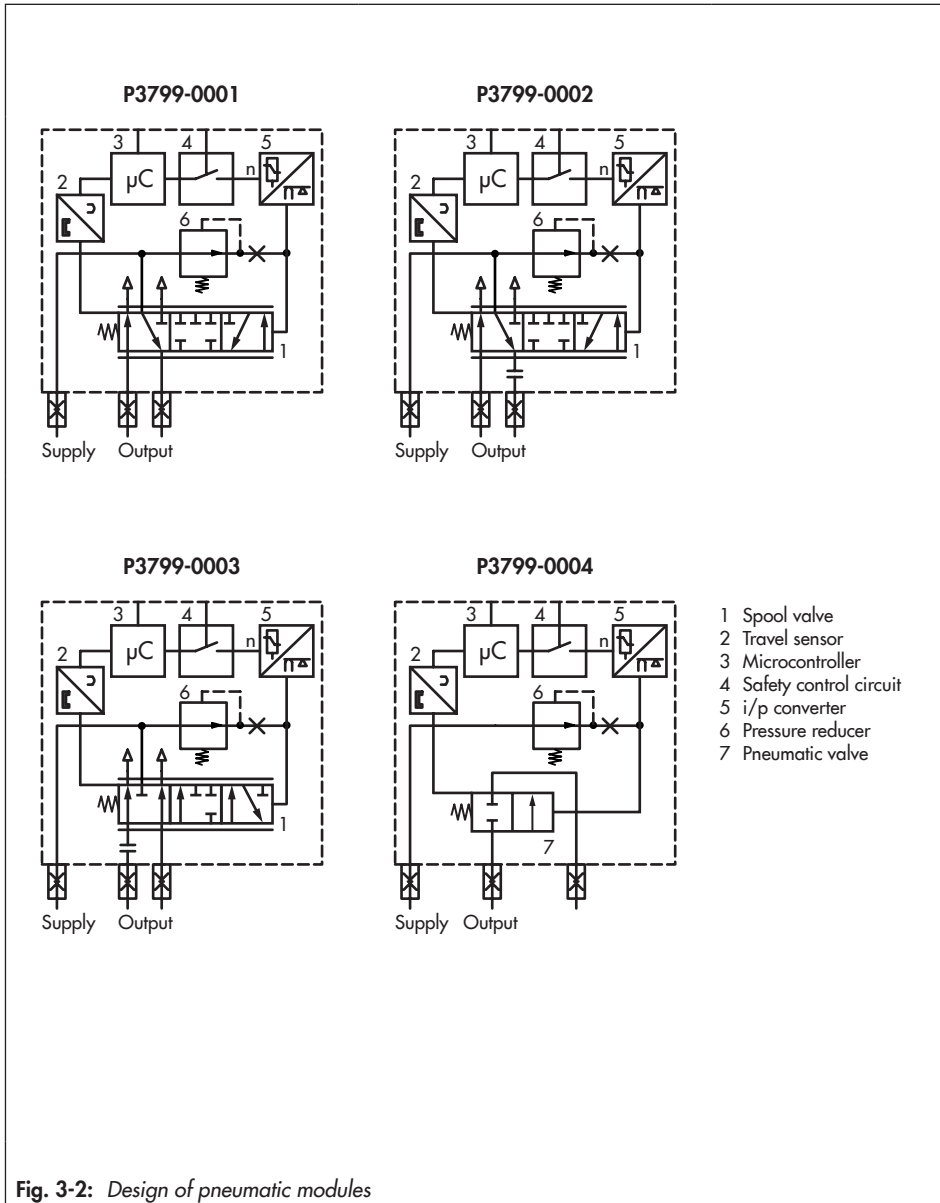

Fig. 3-2: Design of pneumatic modules

Table 3-2: *Permissible combinations of pneumatic modules*

Slot A	Slot B	Function	Air capacity	Fail-safe position	
				Output 138	Output 238
P3799-0001	P3799-0000	Single/double acting	K_{vS} 0.35	Exhaust	Supply
P3799-0001	P3799-0001	Single/double acting	K_{vS} 0.70	Exhaust	Supply
P3799-0002	P3799-0003	Single acting, 2x independent	K_{vS} 0.35	Exhaust	Exhaust
P3799-0003	P3799-0004	Single-acting, fail-in-place	K_{vS} 0.35	Hold position	–

Table 3-3: *Recommended use*

Actuator area of Type 3271/3277	Number of pneumatic modules
120 to 750 cm ² ¹⁾	1x pneumatic module
1000 to 1400-60 cm ²	2x pneumatic modules
1400-120 cm ² or larger	1x pneumatic module plus 1x or more volume boosters

¹⁾ The sizing for the 120 cm² actuator must be performed beforehand.

3.1.1 Option modules

The positioner can be fitted with a maximum of two option modules. The following applies:

- ➔ Do not use option modules with the identical ID code together in one positioner.
- ➔ Check the type of explosion protection of the option modules (see Table 3-4).

Option modules are available for the following additional functions. Table 3-5 lists all option modules.

Hardware limit contacts

Limit contacts with mechanical position pick-up issue a signal to a control system when the valve reaches one of the two adjustable limits.

- Inductive limit contacts: inductive proximity switches are operated by adjustable tags. The operation of the inductive limit contacts requires switching amplifiers to be connected in the output circuit.

Binary output

A fault alarm output signalizes a fault to the control station. The following versions are available:

- Connection to NAMUR switching amplifier acc. to EN 60947-5-6

The binary output can be configured either as a fault alarm output or as a software limit contact.

Table 3-4: Article code of option modules

Option module	Z3799-	x	x	x	x	x
Explosion protection						
Without	0	0	0			
Ex ia	1	1	0			

Table 3-5: Available option modules for the TROVIS 3797 Positioner

Option module		Function		Install and connect option modules (see the 'Installation' chapter)
Article code	Identification	Inductive limit contacts		
Z3799-00000	Dummy module	Binary output		
Z3799-xxx15 ¹⁾	[P]	•	•	

¹⁾ Consisting of an option module and a mechanical assembly unit

3.2 Mounting versions

The TROVIS 3797 Positioner is suitable for the following types of attachment using the corresponding accessories:

- **Direct attachment to Type 3277 Actuator:**

The positioner is mounted on the yoke. The signal pressure is connected to the actuator over a connection block: internally over a hole in the valve yoke for "actuator stem extends" fail-safe action and through an external signal pressure line for "actuator stem retracts" fail-safe action.

- **Attachment to actuators according to IEC 60534-6:**

The positioner is mounted to the control valve using a NAMUR bracket.

- **Attachment to rotary actuators according to VDI/VDE 3845:**

The positioner is mounted to the rotary actuator using the corresponding accessories.

- **Attachment according to VDI/VDE 3847:**

Attachment according to VDI/VDE 3847 using the corresponding accessories allows the positioner to be replaced quickly while the process is running.

3.3 Configuration using the TROVIS-VIEW software

The positioner can be configured with the TROVIS-VIEW software (version 4). For this purpose, the Ethernet port or digital interface, known as the **SAMSON SERIAL INTERFACE (SSP)**, on the positioner is used to connect the USB port of a computer using an adapter cable.

The TROVIS-VIEW software enables the user to easily configure the positioner as well as view process parameters online.

i Note

TROVIS-VIEW can be downloaded free of charge from our website at

► www.samsongroup.com > **DOWNLOADS** > **Software & Drivers** > **TROVIS-VIEW**.

3.4 Technical data

Table 3-6: TROVIS 3797 Electropneumatic Positioner

Travel	
Adjustable travel for	Direct attachment to Type 3277: 3.6 to 30 mm Attachment according to IEC 60534-6 (NAMUR): 5 to 300 mm Attachment according to VDI/VDE 3847-1 5 to 300 mm Attachment according to VDI/VDE 3845 and VDI/ 24 to 100° (170° ¹⁾) VDE 3847-2:
Ethernet APL	
Standard	10BASE-T1L according to IEEE 802.3cg
Transmission rate	10 Mbit/s
Max. connection length	1000 m · Connection at the field switch: spur cable 200 m
Connection	Two-wire, reverse polarity protection 2-WISE according to EN IEC 60079-0:2018, EN 60079-11:2012 and TS IEC 60079-47 Line resistance Rc: 15 to 150 Ω/km Line inductance Le: 0.4 to 1 mH/km Line capacitance: 45 to 200 nF/km The following applies to two-wire/three-wire lines according to EN IEC 60079-14: 200 pF/m and either 1 µH/m or 30 µH/Ω Max. power supply values according to 2-WISE power load APL Port Profile SLAA 15 V DC · 0.54 W
Communication	PROFINET over Ethernet APL
Local	SAMSON SSP interface and serial interface adapter or SSP over APL (software requirements: TROVIS-VIEW with database module 3797)
Supply	
Supply air	2.5 to 10 bar/30 to 150 psi
Air quality acc. to ISO 8573-1	Max. particle size and density: Class 4 Oil content: Class 3 Pressure dew point: Class 3 or at least 10 K below the lowest ambient temperature to be expected
Signal pressure (output)	0 bar up to supply pressure
Hysteresis	≤0.3 %
Sensitivity	≤0.1 %, adjustable by software

Start-up time	After interrupted operation < 300 ms: 100 ms After interrupted operation > 300 ms: ≤2 s
Transit time	Up to 10000 s separately adjustable for exhaust and supply by software
Direction of action	Reversible
Air consumption ²⁾	≤300 l _n /h with 6 bar supply pressure, depending on module
Air output capacity (when Δp = 6 bar)	
Actuator (supply)	32 m _n ³ /h with one pneumatic module (K _{V max (20 °C)} = 0.34)
	60 m _n ³ /h with two pneumatic modules of the same sort (K _{V max (20 °C)} = 0.64)
Actuator (exhaust)	37 m _n ³ /h with one pneumatic module (K _{V max (20 °C)} = 0.40)
	70 m _n ³ /h with two pneumatic modules of the same sort (K _{V max (20 °C)} = 0.75)
Environmental conditions and permissible temperatures	
Permissible environmental conditions according to EN 60721-3	
Storage	1K6 (relative humidity ≤95 %)
Transport	2K4
Operation	4K4 -40 to +85 °C (versions with metal cable glands) Ex version: -40 to 80 °C (with metal cable gland). The limits in the test certificate additionally apply.
Resistance to vibration	
Vibrations (sinusoidal)	According to DIN EN 60068-2-6: 0.15 mm, 10 to 60 Hz; 20 m/s ² , 60 to 500 Hz per axis 0.75 mm, 10 to 60 Hz; 100 m/s ² , 60 to 500 Hz per axis
Bumps (half sine)	According to DIN EN 60068-2-29: 150 m/s ² , 6 ms; 4000 bumps per axis
Noise	According to DIN EN 60068-2-64: 10 to 200 Hz: 1 (m/s ²) ² /Hz 200 to 500 Hz: 0.3 (m/s ²) ² /Hz 4 h/axis
Recommended continuous duty	≤20 m/s ²
Influences	
Temperature	≤0.15 %/10 K
Supply	None

Design and principle of operation

Requirements	
EMC	Complying with EN 61000-6-2, EN 61000-6-3, EN 61326-1 and NAMUR Recommendation NE 21
Degree of protection	IP66
Conformity	
Electrical connections	
Cable glands	Max. four, M20x1.5
Terminals	Screw terminals for 0.2 to 2.5 mm ² wire cross-section
	For option modules: 0.2 to 1.5 mm ²
Communication	
	TROVIS VIEW with SSP/PROFINET
Explosion protection	
	See Table 3-9
Materials	
Housing and cover	Die-cast aluminum EN AC-ALSi12 (Fe) (EN AC-44300) acc. to DIN EN 1706, chromate and powder coating Stainless steel 1.4408
Window	Makrolon® 2807
Cable glands	Nickel-plated brass, stainless steel 1.4305, polyamide
Other external parts	Stainless steel 1.4571 and 1.4404 (316 L)
Weight	
	1.4 to 1.6 kg (depending on version)
	Stainless steel: 3.2 to 3.4 kg (depending on version)

1) On request

2) Based on temperature range -40 to +80 °C

Table 3-7: *Optional additional functions*

Binary output (NAMUR)		
Version	Galvanic isolation, reverse polarity protection, switching output acc. to EN 60947-5-6	
Signal state	Non-conducting	≤1.0 mA
	Conductive	≥2.2 mA
Static destruction limit	32 V DC/24 V AC	

Inductive limit contacts	
Version	For connection to switching amplifier according to EN 60947-5-6, SJ2-SN proximity switches, reverse polarity protection
Measuring plate not detected	≥ 3 mA
Measuring plate detected	≤ 1 mA
Static destruction limit	20 V DC
Permissible ambient temperature	-50 to +85 °C

Table 3-8: Pressure sensors

Pressure sensors	
Pressure range	0 to 10 bar

Table 3-9: Summary of explosion protection approvals

TROVIS 3797	Certification		Type of protection
-110	ATEX	Number BVS 21 ATEX E 080 Date 2024-05-14	II 2 G Ex ia IIC T4/T6 Gb
-111	IECEX	Number IECEX BVS 21.0083 Date 2024-05-21	Ex ia IIC T4/T6 Gb
-112	CCC Ex	Number 2024322307006083 Date 2024-07-15 Valid until 2029-07-15	Ex ia IIC T4/T6 Gb
-112	NEPSI	Number GYJ24.1168 Date 2024-07-07 Valid until 2029-07-06	Ex ia IIC T4/T6 Gb

3.5 Dimensions in mm

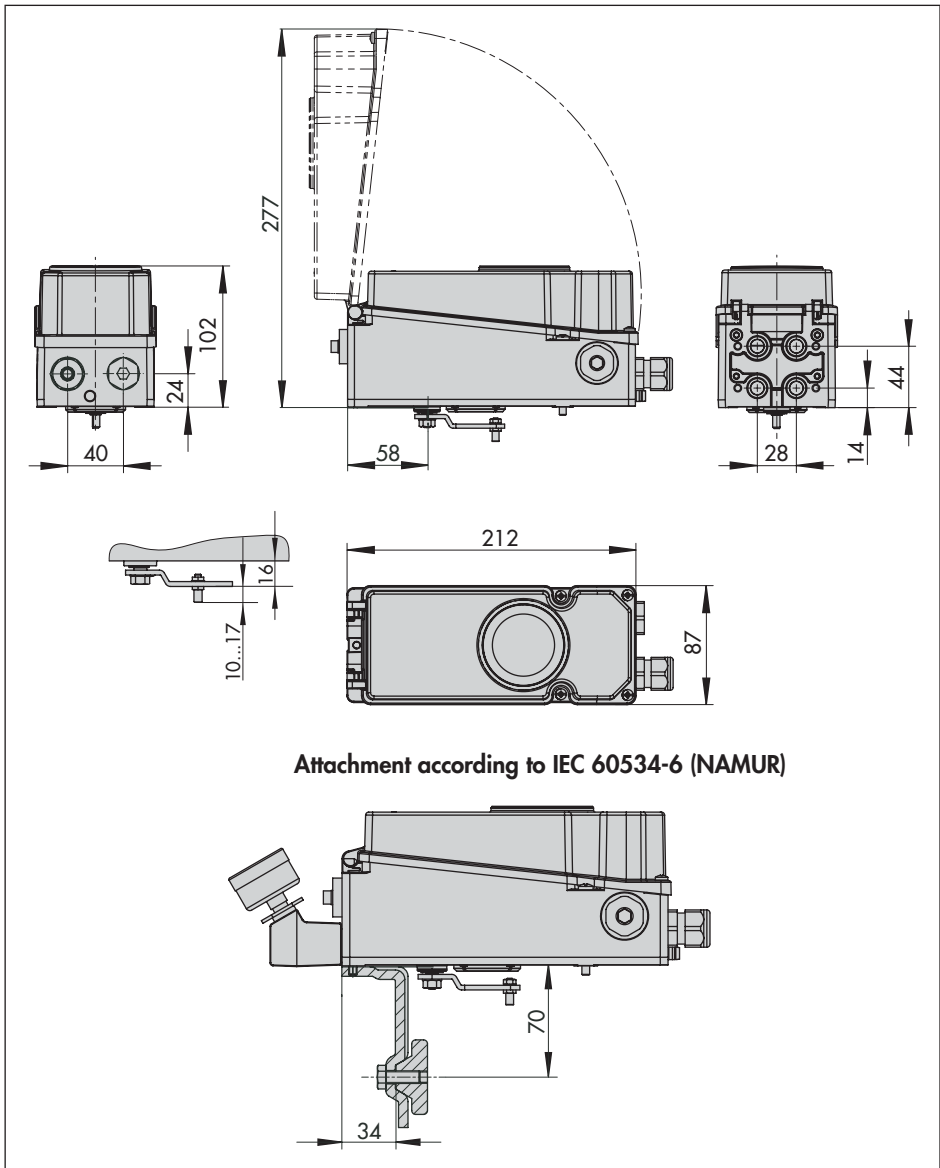

Pressure gauge bracket, two pressure gauges

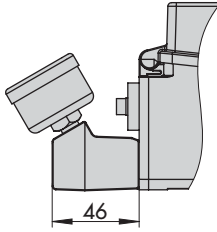

Pressure gauge bracket, three pressure gauges

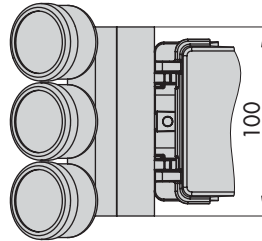
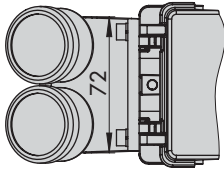
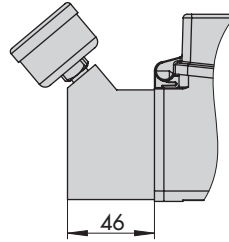

Connecting plate

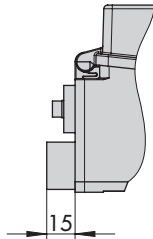

Attachment according to
VDI/VDE 3847-1 onto
Type 3277 Actuator

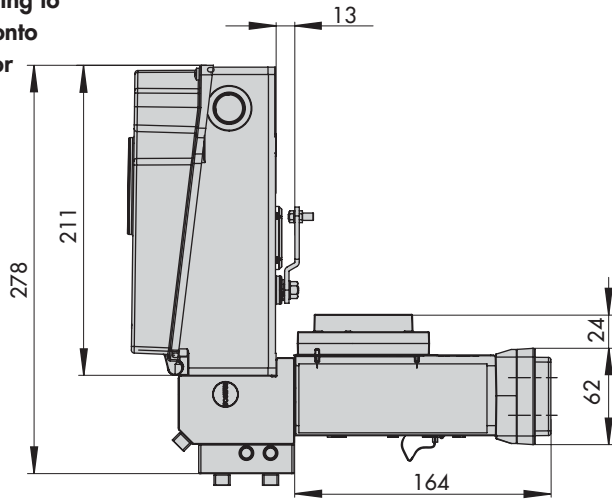

Attachment according to VDI/
VDE 3847-1 to a NAMUR rib

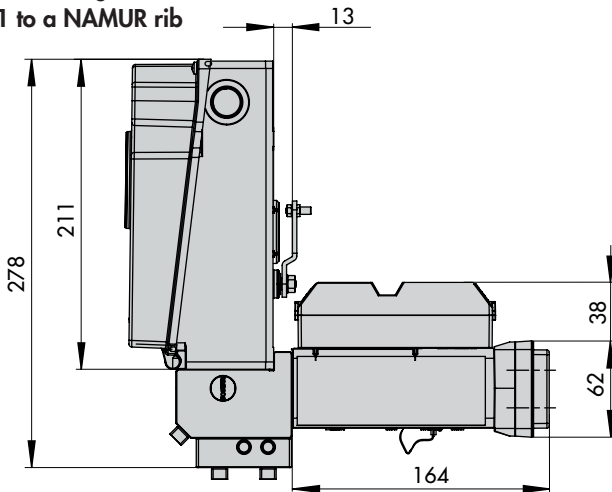

Attachment to rotary actuators according to VDI/VDE 3847-2

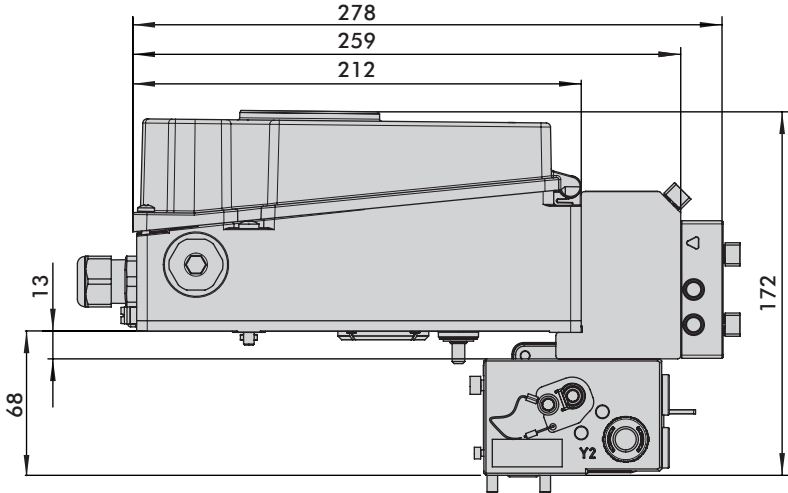

Attachment to rotary actuators according to VDI/VDE 3845

Fixing level 1, AA1 to AA4 size, see the 'Installation' chapter

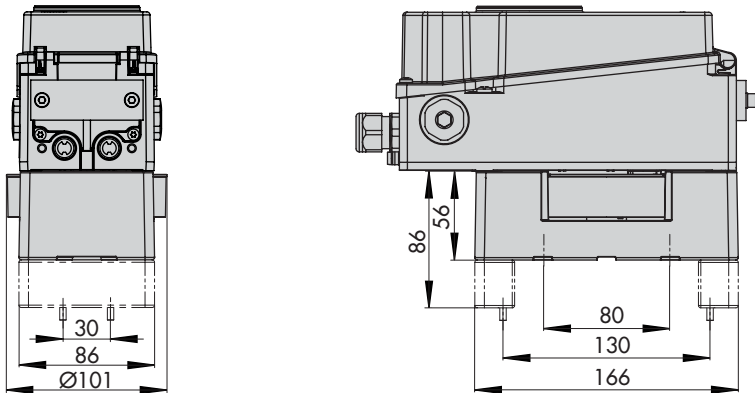

Lever

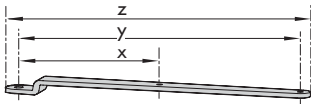

Lever	x	y	z
M	25 mm	50 mm	66 mm
L	70 mm	100 mm	116 mm
XL	100 mm	200 mm	216 mm
XXL	200 mm	300 mm	316 mm

3.6 Fixing levels according to VDI/VDE 3845 (September 2010)

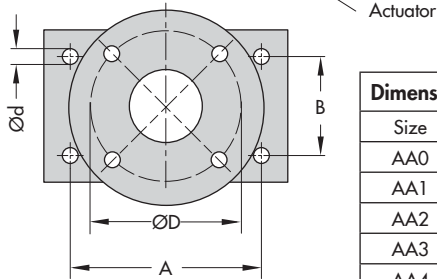
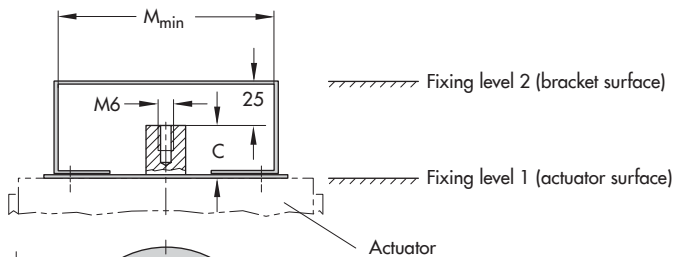

Dimensions in mm						
Size	A	B	C	Ød	M _{min}	D ¹⁾
AA0	50	25	15	5.5 for M5	66	50
AA1	80	30	20	5.5 for M5	96	50
AA2	80	30	30	5.5 for M5	96	50
AA3	130	30	30	5.5 for M5	146	50
AA4	130	30	50	5.5 for M5	146	50
AA5	200	50	80	6.5 for M6	220	50

¹⁾ Flange type F05 acc. to DIN EN ISO 5211

4 Shipment and on-site transport

The work described in this chapter is to be performed only by personnel appropriately qualified to carry out such tasks.

4.1 Accepting the delivered goods

After receiving the shipment, proceed as follows:

1. Check the scope of delivery. Check that the specifications on the nameplate of the positioner match the specifications in the delivery note. See the 'Markings on the device' chapter for nameplate details.
2. Check the shipment for transportation damage. Report any damage to SAMSON and the forwarding agent (refer to delivery note).

4.2 Removing the packaging from the positioner and pneumatic modules

Observe the following sequence:

- Do not remove the packaging until immediately before installing the positioner and pneumatic modules.
- Dispose and recycle the packaging in accordance with the local regulations.

4.3 Transporting the positioner and pneumatic modules

- Pack the positioner and pneumatic modules properly to comply with terms of transportation.

Transport instructions

- Protect the positioner and pneumatic modules against external influences (e.g. impact).
- Protect the positioner and pneumatic modules against moisture and dirt.
- Observe transport temperature depending on the permissible ambient temperature (see the 'Design and principle of operation' chapter).

4.4 Storing the positioner and pneumatic modules

⚠ NOTICE

Risk of damage to the positioner and pneumatic modules due to improper storage.

- *Observe the storage instructions.*
 - *Avoid longer storage periods.*
 - *Contact SAMSON in case of different storage conditions.*
-

⚠ Note

SAMSON recommends to regularly check the device and the prevailing conditions during long storage periods.

Shipment and on-site transport

Storage instructions

- Protect the positioner, pneumatic modules and option modules against external influences (e.g. impact).
- Protect the positioner, pneumatic modules and option modules against moisture and dirt. Store them at a relative humidity of less than 75 %. In damp spaces, prevent condensation. If necessary, use a drying agent or heating.
- Make sure that the ambient air is free of acids or other corrosive media.
- Observe transport temperature depending on the permissible ambient temperature (see the 'Design and principle of operation' chapter).
- Do not place any objects on the positioner, pneumatic modules and option modules.

5 Installation

The work described in this chapter is to be performed only by personnel appropriately qualified to carry out such tasks.

⚠ DANGER

Risk of fatal injury due to the ignition of an explosive atmosphere.

- Observe EN 60079-14 (VDE 0165, Part 1) for work on the positioner in potentially explosive atmospheres.
- Work in potentially explosive atmospheres is to be performed only by personnel who has undergone special training or instructions or who is authorized to work on explosion-protected devices in hazardous areas.

⚠ DANGER

Risk of bursting in the pneumatic actuator due to the use of a fail-in-place module.

Before working on the positioner, actuator or any other valve accessories:

- Depressurize all plant sections concerned and the actuator. Release any stored energy.

⚠ WARNING

Crush hazard arising from actuator and plug stem moving.

- Do not insert hands or finger into the yoke while the air supply is connected to the positioner.

- Before working on the positioner, disconnect and lock the pneumatic air supply.
- Do not impede the movement of the actuator and plug stem by inserting objects into the yoke.

5.1 Installation conditions

Work position

The work position for the positioner is the front view onto the operating controls on the positioner seen from the position of operating personnel.

Operators must ensure that, after installation of the positioner, the operating personnel can perform all necessary work safely and easily access the device from the work position.

Mounting orientation

- See Fig. 5-1 for permissible mounting position.
- Do not seal or restrict the vent opening (see Fig. 5-2) when the device is installed on site.

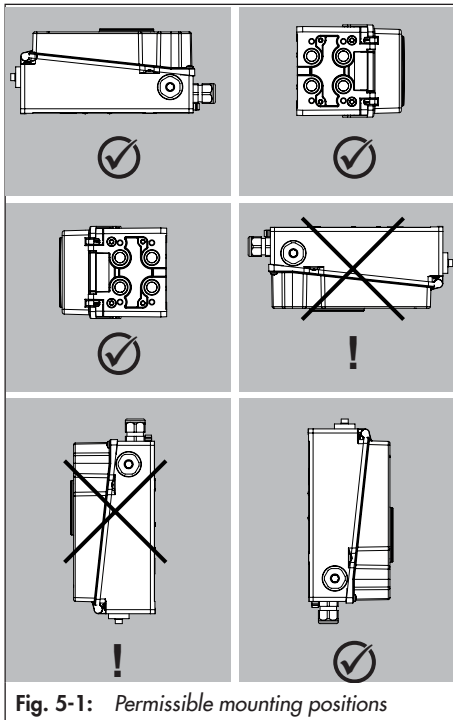

Fig. 5-1: Permissible mounting positions

→ Install the pneumatic modules, option modules and dummy module (see Chapter 5.2.3 and Chapter 5.2.4).

5.2.1 Adjusting the lever and pin position

The positioner is adapted to the actuator and to the rated travel by the lever on the back of the positioner and the pin inserted into the lever.

The travel tables on page 5-4 show the maximum adjustment range at the positioner. The travel that can be implemented at the valve is additionally restricted by the selected fail-safe position and the required compression of the actuator springs.

The positioner is equipped with the M lever (pin position 50) as standard (see Fig. 5-3). If a pin position other than position 50 with the standard M lever is required or an L or XL lever size is required, proceed as follows (see Fig. 5-4):

1. Remove the follower pin (2) from its pin position and move it to the hole for the recommended pin position (according to travel tables on page 5-4) and screw tight. Only use the longer follower pin included in the mounting kit.
2. Place the lever (1) on the shaft of the positioner and fasten it tight using the disk spring (1.2) and nut (1.1). Use a tightening torque of 7.0 ± 1.0 Nm.

5.2 Preparation for installation

Before installation, make sure that the following conditions are met:

- The positioner is not damaged.

Proceed as follows:

- Lay out the necessary material and tools to have them ready during installation work.
- Adjust correct lever and pin position (see Chapter 5.2.1).
- Remove the protective caps from the pneumatic connections.

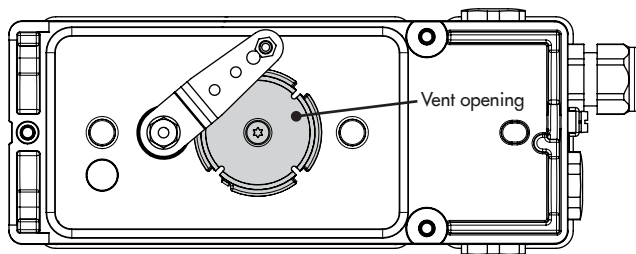

Fig. 5-2: Vent opening (back of the positioner)

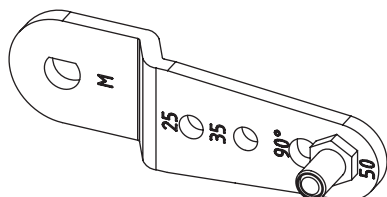

Fig. 5-3: M lever with pin position 50

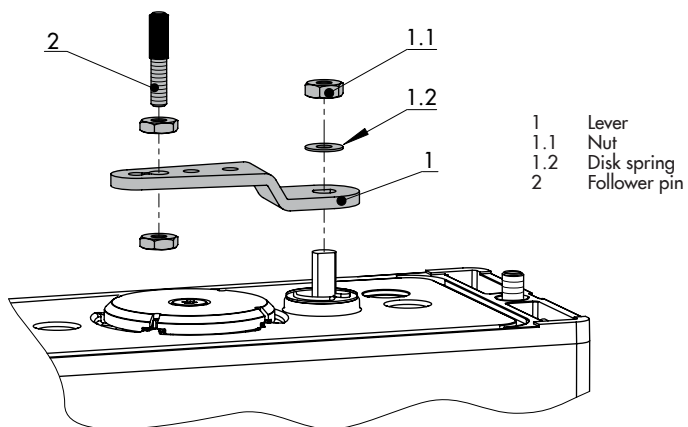

Fig. 5-4: Mounting the lever and follower pin

Installation

Travel tables

i Note

The **M** lever is included in the scope of delivery.

L, **XL**, **XXL** levers for attachment according to IEC 60534-6 (NAMUR) are available as accessories.

Table 5-1: Travel table for direct attachment to Type 3277 Actuator

Actuator size cm ²	Rated travel mm	Adjustment range at positioner Travel [mm]	Required lever	Assigned pin position
120 ¹⁾	7.5	5.0 to 25.0	M	25
120 ¹⁾ /175/240/350	15	7.0 to 35.0	M	35
355/700/750	30	10.0 to 50.0	M	50

¹⁾ Only external air routing possible

Table 5-2: Travel table for attachment according to IEC 60534-6 (NAMUR)

SAMSON valves with Type 3271 Actuator		Adjustment range at positioner Other control valves		Required lever	Assigned pin position
Actuator size cm ²	Rated travel mm	Min. travel mm	Max. travel mm		
240/350/355/ 700/750	7.5 and 15	7.0	35.0	M	35
120/175	7.5	5.0	25.0	M	25
355/700/750	30	10.0	50.0	M	50
1000/1400/2800	30	14.0	70.0	L	70
	60	20.0	100.0	L	100
1400/2800	120	40.0	200.0	XL	200
1400	250	60.0	300.0	XXL	300

Table 5-3: Travel table for attachment to rotary actuators

Opening angle	Required lever	Assigned pin position
24 to 100°	M	90°

5.2.2 Checking the switch position for the dummy module

A dummy module is inserted into slot D to protect the contacts of slots C and D upon delivery of the positioner. The associated switch is switched to the '0' setting.

NOTICE

Risk of positioner damage due to operating the positioner without a module installed in slot D.

- ➔ Do **not** remove the dummy module.
- ➔ Do **not** change the switch position for the dummy module

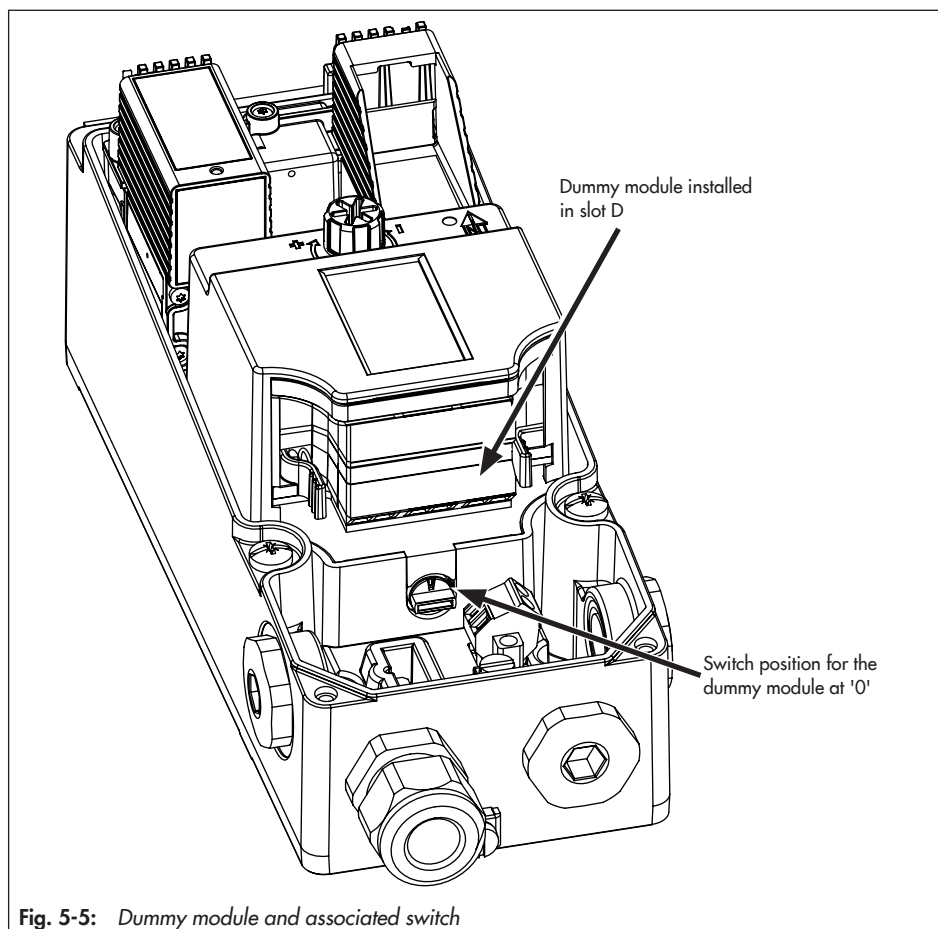

5.2.3 Installing and removing pneumatic modules

- Before installing or removing pneumatic modules, make sure that:
- The air is not yet connected to the positioner or the air supply is disconnected while the modules are being removed or installed.
 - The power is not yet connected to the positioner or the positioner is not powered while the modules are being removed or installed.

Two slots are available for the pneumatic modules in the positioner (see Fig. 5-7).

One pneumatic module together with a dummy module must be installed. A slot without an installed module is not permissible.

Removing the pneumatic/dummy module

1. Unscrew the fastening screw using a flat-blade screwdriver (1.5 turns of the screw).
2. Push the module towards the display and carefully pull it out.
3. Store the module in its packaging.

Installing the pneumatic/dummy module

1. Observe permissible combinations of pneumatic modules specified in Fig. 5-7.
2. Check that the seal on the module is properly seated (see Fig. 5-9): The seal must not protrude out of the groove.
3. Turn the screw to push the wedge downward as far as it will go (see Fig. 5-8).

4. Install the module as shown in Fig. 5-6. Press the module toward the display and insert it along the wedge.
5. Lightly push the module downward, while tightening the fastening screw using a suitable flat-blade screwdriver. Tighten it with a torque of 0.7 ± 0.1 Nm.

If the changes have been made to the pneumatic modules, the positioner must re-initialized (see the 'Start-up' chapter).

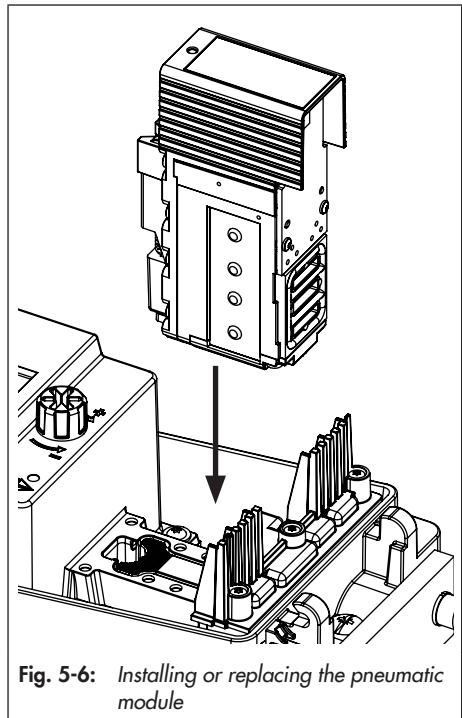
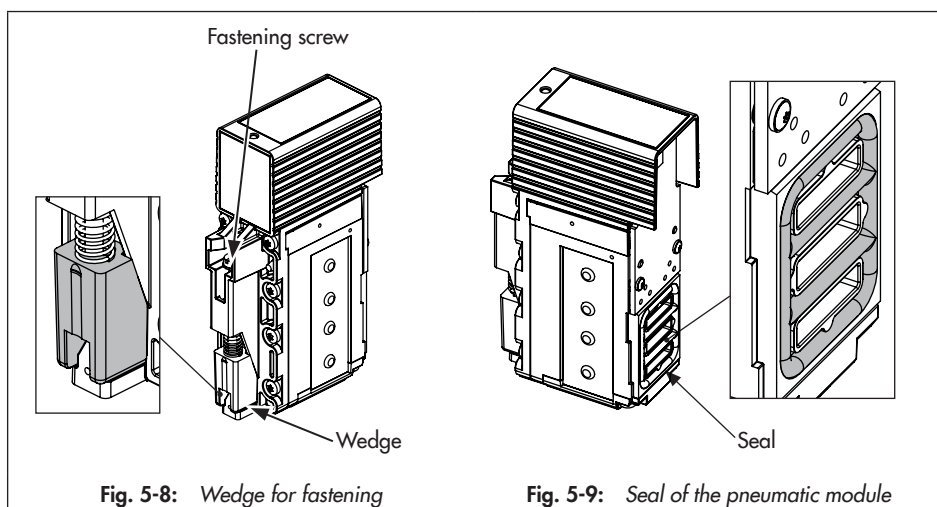
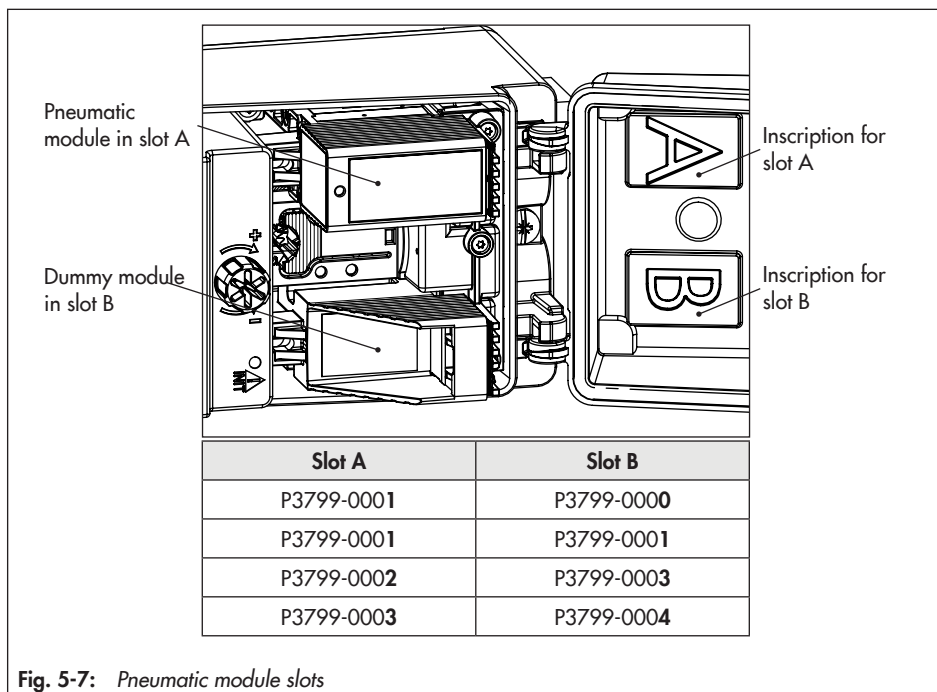

Fig. 5-6: Installing or replacing the pneumatic module



5.2.4 Installing and removing option modules

! NOTICE

Electrostatic discharge will damage the option modules.

- Observe the ESD requirements according to IEC 61340-5-1.
- Only store option modules in their original packaging.

→ Before installing or removing option modules, make sure that:

- The air is not yet connected to the positioner or the air supply is disconnected while the modules are being removed or installed.
- The power is not yet connected to the positioner or the positioner is not powered while the modules are being removed or installed.
- The explosion protection certificate of the option modules used is the same as that of the positioner (see the 'Design and principle of operation' chapter).

Two slots are available for the option modules in the positioner (see Fig. 5-11).

A dummy module is inserted into slot D to protect the slots' contacts upon delivery of the positioner without option modules. Depending on which slot remains free, the dummy module must be adapted to the slot by breaking off the corresponding edges. Break off the edges with a pair of pliers at the predetermined breaking points.

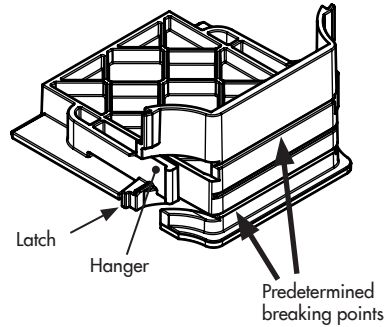

Dummy module in the delivered state

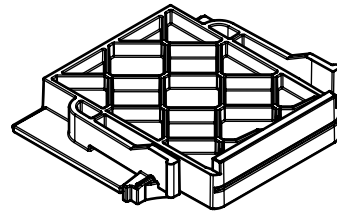

Dummy module adapted for installation in slot C (top and bottom edges snapped off)

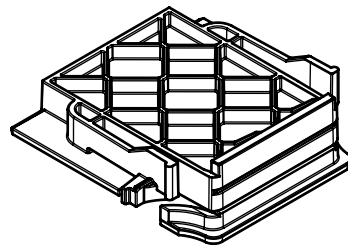

Dummy module adapted for installation in slot D (top edge snapped off)

Fig. 5-10: Dummy module

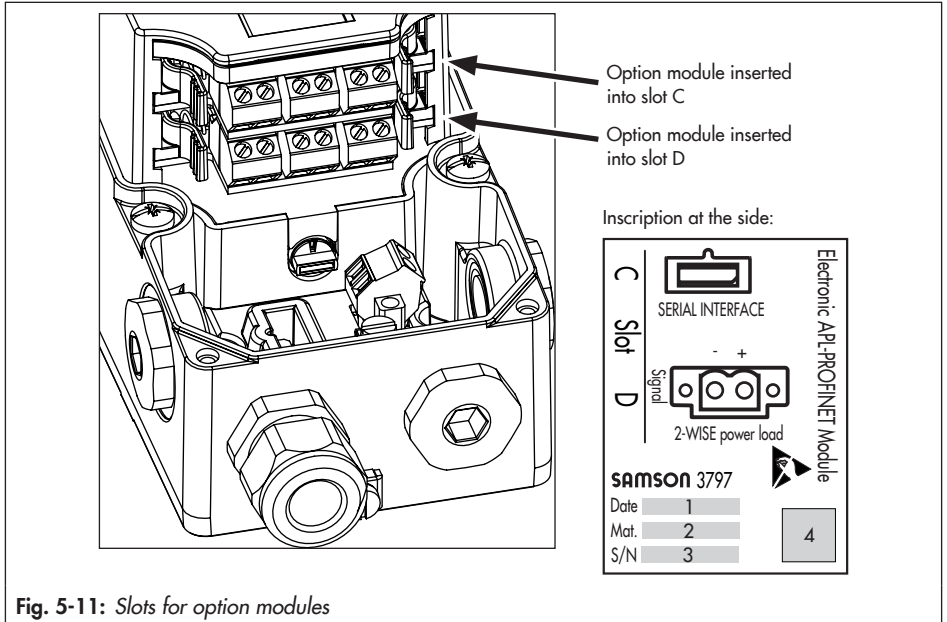

When option modules are used, either two option modules or an option module and a dummy module must be installed. A slot without an installed module is not permissible.

Removing the dummy module

1. Take hold of the dummy module at the tabs.
2. Press the tabs and carefully pull the dummy module out of the slot.

Installing the dummy module

1. Select the right slot for the dummy module.
2. Take hold of the dummy module at the tabs.

3. Press the tabs and carefully push the dummy module into the slot until the latches engage into the recesses intended for them.
4. Release the tabs to allow the latches to engage with a clicking sound.

Installing the option module

1. Select the slot for option module as listed in Table 5-4.
2. Take hold of the option module at the tabs (see Fig. 5-12).
3. Press the tabs and carefully push the option module into the slot until the latches engage into the recesses intended for them.

Installation

4. Release the tabs to allow the latches to engage.
 5. Check to ensure the option module is properly seated.
 6. For option modules [F], [V], [E] and [Y], proceed as described in Chapter 5.2.5.
- ➔ Connect the electrical supply after installing the positioner (see Chapter 5.5).
 - ➔ Set the parameters of the option module after initialization (see the 'Start-up and configuration' chapter).

i Note

After installing the option module, stick the corresponding labels (see the 'Design and principle of operation' chapter) next to the positioner's nameplate on the housing.

➔ Take the label out of the packaging.

Removing the option module

1. Disconnect the connecting cables.
2. Take hold of the option module at the tabs.
3. Press the tabs and carefully pull the option module out of the slot.
4. Store the option module in its packaging.
5. Remove the label from the positioner housing.

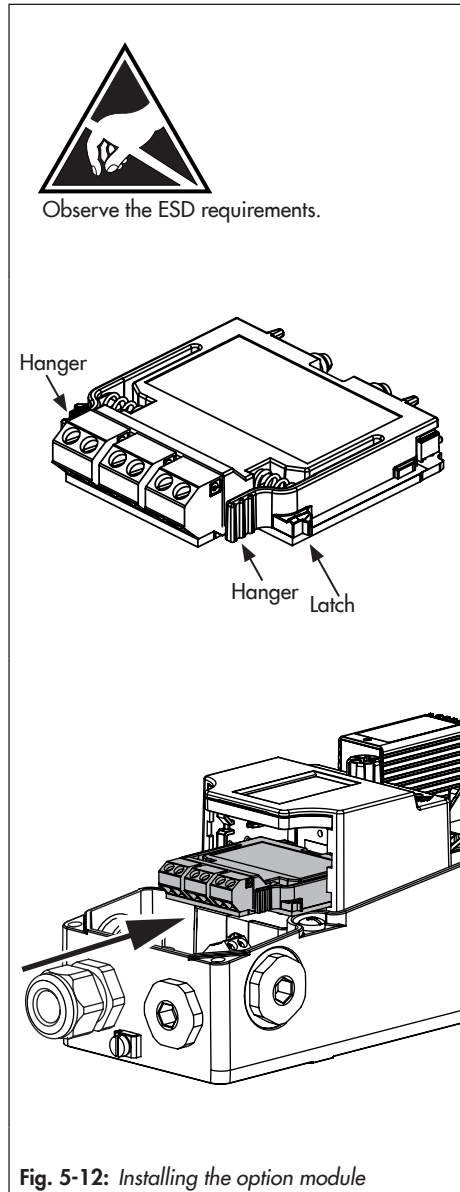

Table 5-4: Permissible slots for option modules

Option module		Function		Permissible slot	
				C	D
Article code	Identification				
Z3799-00000	Dummy module			Yes	Yes
Z3799-xxx15	[P]	•	•	No	Yes

5.2.5 Preparing option modules for use

Before the positioner can be used with option module [P], further action is necessary after the option module has been installed to render it ready for use.

a) Hardware limit contacts (option module [P])

To use the hardware limit contacts (mechanical and inductive limit contacts), the mechanical assembly unit must be installed in addition to the option module [P] or [F] since limit contacts and the option module are connected with each other over signal lines.

NOTICE

Incorrect installation or removal of option modules will damage the positioner.

→ Disconnect the electrical power before installing or removing the option modules.

NOTICE

Electrostatic discharge will damage the option modules.

→ Observe the ESD requirements according to IEC 61340-5-1.

→ Only store option modules in their original packaging.

Installing the hardware limit contact assembly

After the option module has been correctly installed:

1. Guide the mechanical assembly over the display and install it as shown in Fig. 5-13. Make sure that the pinion shaft engages with the gear wheel for transmission of the position pick-up. If it cannot be installed because the gear wheels are in the way, slightly turn the pinion shaft.
 2. Carefully push the mechanical assembly unit down as far as it will go.
 3. Use a suitable screwdriver to tighten the screws using a tightening torque of 1.2 ± 0.2 Nm.
-

Note

If the hardware limit contacts are installed in the positioner for the first time, the screws tap a thread into the boreholes. In this case, it will be more difficult to screw in the screws. If the mechanical limit contacts have been removed, proceed as follows to re-install them:

- Briefly turn the fastening screws counter-clockwise with the screwdriver to engage them into the ready-tapped thread.
 - Tighten the screws applying a tightening torque of 1.2 ± 0.2 Nm.
-

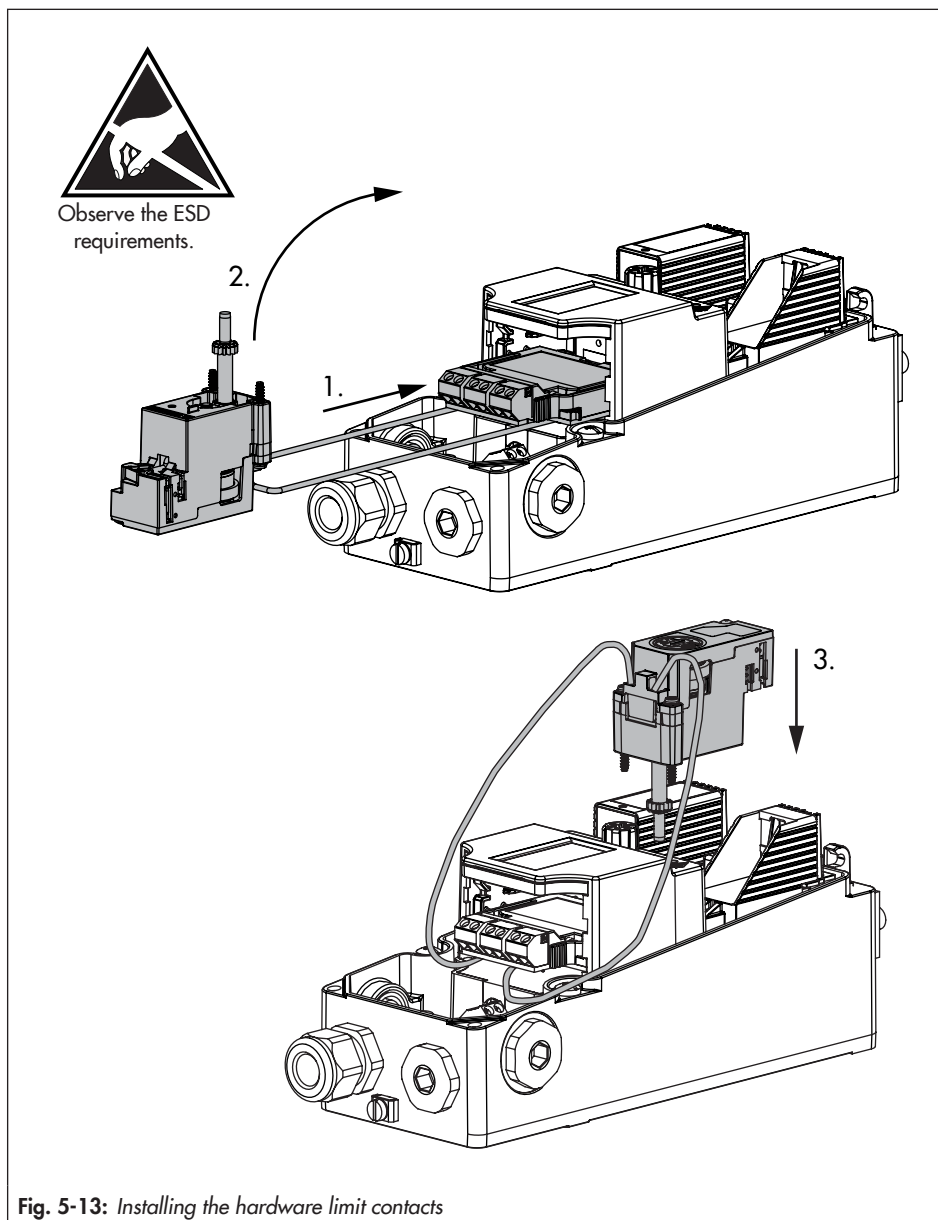

Installation

4. Clamp the two connecting lines between the electronic module and the positioner housing and push them downward (as shown in Fig. 5-14). Make sure that the wires do not project out of the housing and get caught when closing the housing cover.
- ➔ Connect the electrical supply after installing the positioner (see Chapter 5.5).
 - ➔ Adjust the switching points on start-up of the positioner (see the 'Start-up and configuration' chapter).

Shaft locking

To lock the positioner shaft on mounting the positioner on the valve, insert a flat-blade screwdriver into the groove of the limit contact assembly and hold the shaft in position 2 (see Fig. 5-15).

NOTICE

Impermissible turning of the positioner shaft will damage the positioner.

Only adjust the positioner shaft with a flat-blade screwdriver to lock it in place during attachment to the valve.

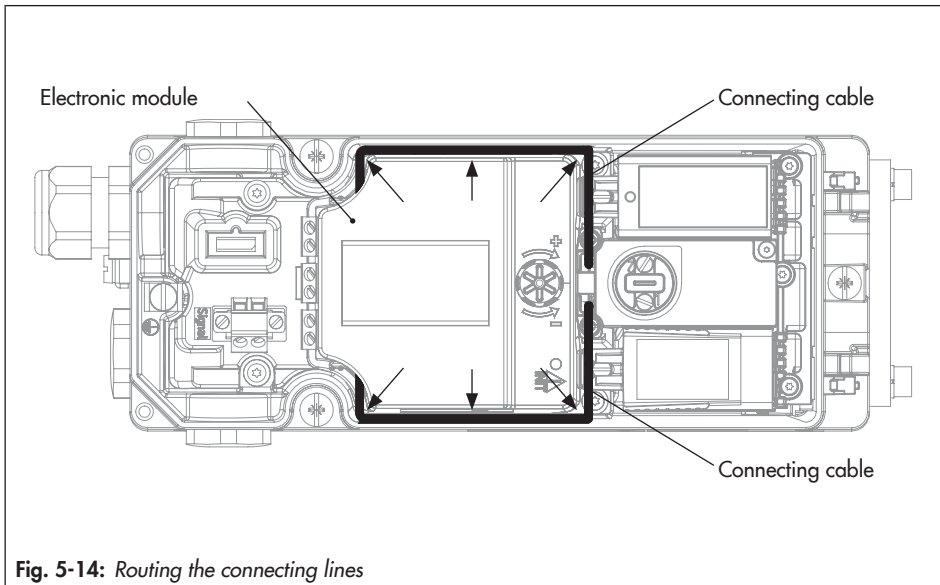

Fig. 5-14: Routing the connecting lines

5.3 Positioner attachment

5.3.1 Mounting on Type 3277 Actuator

- See Fig. 5-15
 - Required mounting parts and accessories: see Chapter 5.6, Table 5-6.
 - Observe travel tables on page 5-4.
 - Read instructions in the gray box at the end of this chapter if the positioner is to be operated with air purging function.
1. Place follower clamp (3) on the actuator stem, align it and screw tight so that the mounting screw is located in the groove of the actuator stem.
 2. Mount cover plate (10) with narrow side of the cut-out pointing towards the signal pressure connection. Make sure that the glued-on flat gasket (14) points towards the actuator yoke.
 3. Check the pin position of the follower pin (2) on M lever (1). Refer to travel tables for type of attachment. If necessary, change the pin position (see Chapter 5.2.1).
 4. Insert molded seal (15) into the groove of the positioner housing.
 5. Turn the lever counterclockwise until the spring force can be felt (position 1). Continue to turn the lever further to position 2 (see Fig. 5-15, bottom right).
 6. Press the shaft lock (see Fig. 5-15, bottom left) to hold the lever in position 2.
 7. Place positioner on the cover plate in such a manner that the follower pin (2) rests on the top of the follower clamp (3). The lever (1) must rest on the follower clamp with spring force.
Fasten the positioner on the cover plate (10) using the three fastening screws.
 8. Make sure that the tip of the gasket (16) projecting from the side of the connection block is positioned to match the actuator symbol for the actuator's fail-safe action "actuator stem extends" or "actuator stem retracts". If this is not the case, unscrew the three fastening screws and lift off the cover. Turn the gasket (16) by 180° and re-insert it.
 9. Place the connection block (12) with the associated seals against the positioner and the actuator yoke and fasten using the screw (12.1). For actuators with fail-safe action "actuator stem retracts", additionally remove the blanking plug (12.2) and mount the external signal pressure pipe.
 10. Mount cover (11) on the other side.
Make sure that the vent plug is located at the bottom when the control valve is installed to allow any condensed water that collects to drain off. The outputs 79 and 238 must be sealed with the dummy plate (see Chapter 5.4).

i Note

This type of attachment is not recommended when two pneumatic modules are used as the connection block reduces the K_v coefficient.

Operation with air purging function for single-acting actuators

To use instrument air leaving the positioner for corrosion protection inside the actuator, proceed as follows:

- **"Actuator stem extends" direction of action:** remove the blanking plug (12.2) at the connection block and make a pneumatic connection to the actuator chamber on the exhaust side. If an obsolete connection block that is no longer available is used (order no. 1400-8811 or 1400-8812), read the attachment instructions described in Chapter 5.3.2.
- The air purging function exists automatically for **"actuator stem retracts" direction of action.**

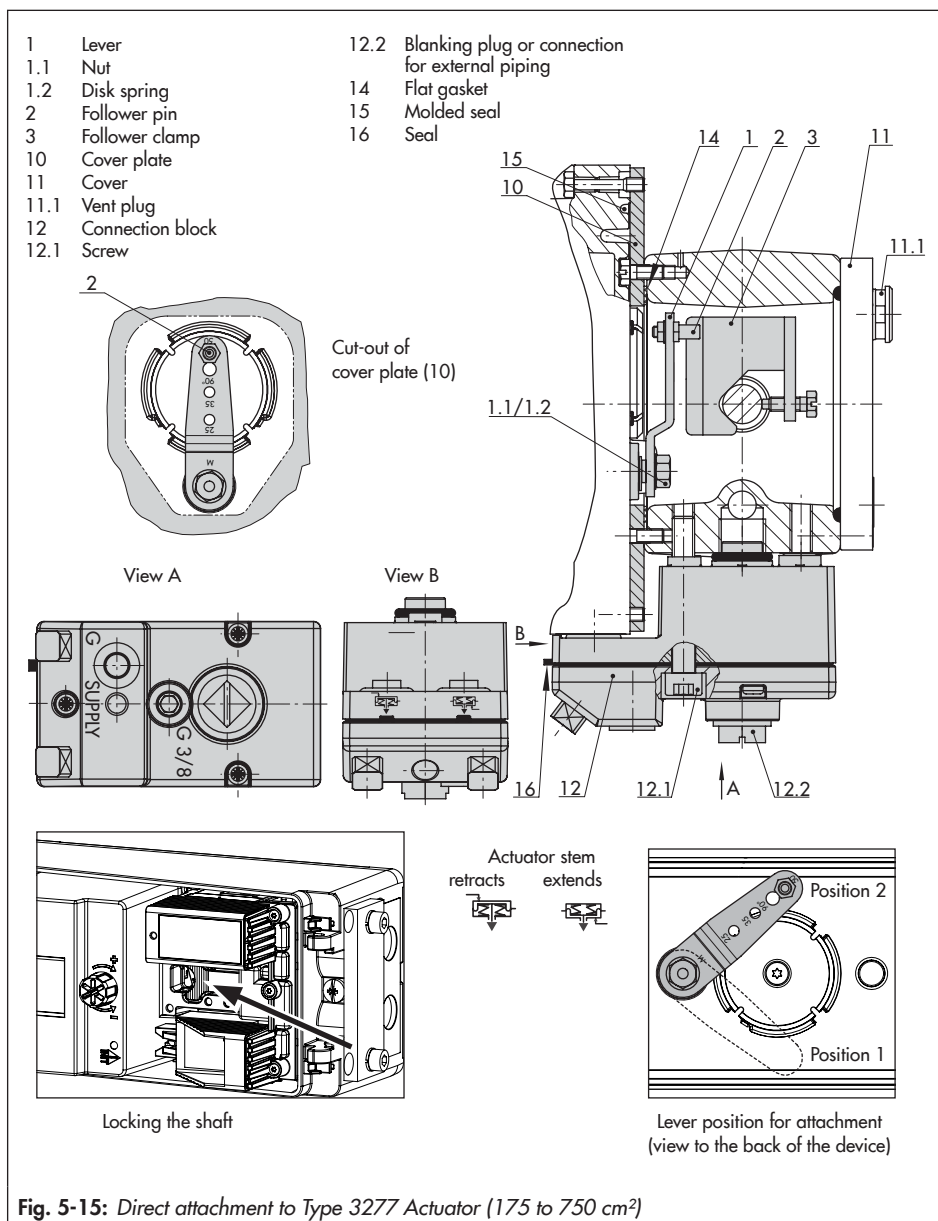

Fig. 5-15: Direct attachment to Type 3277 Actuator (175 to 750 cm²)

5.3.2 Attachment according to IEC 60534-6

- ➔ See Fig. 5-16
- ➔ Required mounting parts and accessories: see Chapter 5.6, Table 5-7.
- ➔ Observe travel tables on page 5-4.
- ➔ Read instructions in the gray box at the end of this chapter if the positioner is to be operated with air purging function.

1. Screw the two bolts (14) to the bracket (9.1) of the stem connector (9), place the follower plate (3) on top and use the screws (14.1) for fastening.

Actuator sizes 2800 cm² and 1400 cm² with 120 mm travel:

2. Mount the NAMUR bracket (10):
 - Mount connecting plate (6) or pressure gauge bracket (7) with pressure gauges (8) on the positioner. Make sure that the two seals (6.1) are seated properly.
 - Select required lever (1) **M**, **L** or **XL** and pin position according to the actuator size and valve travel (see Chapter 5.2.1).
3. Place positioner on the NAMUR bracket in such a manner that the follower pin (2) rests in the slot of the follower plate (3, 3.1). Adjust the lever (1) correspondingly.
Screw the positioner to the NAMUR bracket using the three fastening screws.

Operation with air purging function for single-acting actuators

To use instrument air leaving the positioner for corrosion protection inside the actuator, proceed as follows:

1. Mount the connecting plate and connect output 79 to the actuator's spring chamber.
2. Seal output 238 in single-acting actuators.

Should other valve accessories be used which vent the actuator (e.g. solenoid valve, volume booster, quick exhaust valve), this exhaust air must also be included in the purging function. The connection at the positioner must be protected with a check valve (e.g. screw fitting with restriction G 1/4, order no. 1991-5777) or 1/4 NPT (order no. 1992-3178) mounted in the piping. Otherwise the pressure in the positioner housing would rise above the ambient pressure and damage the positioner when the exhausting components respond suddenly.

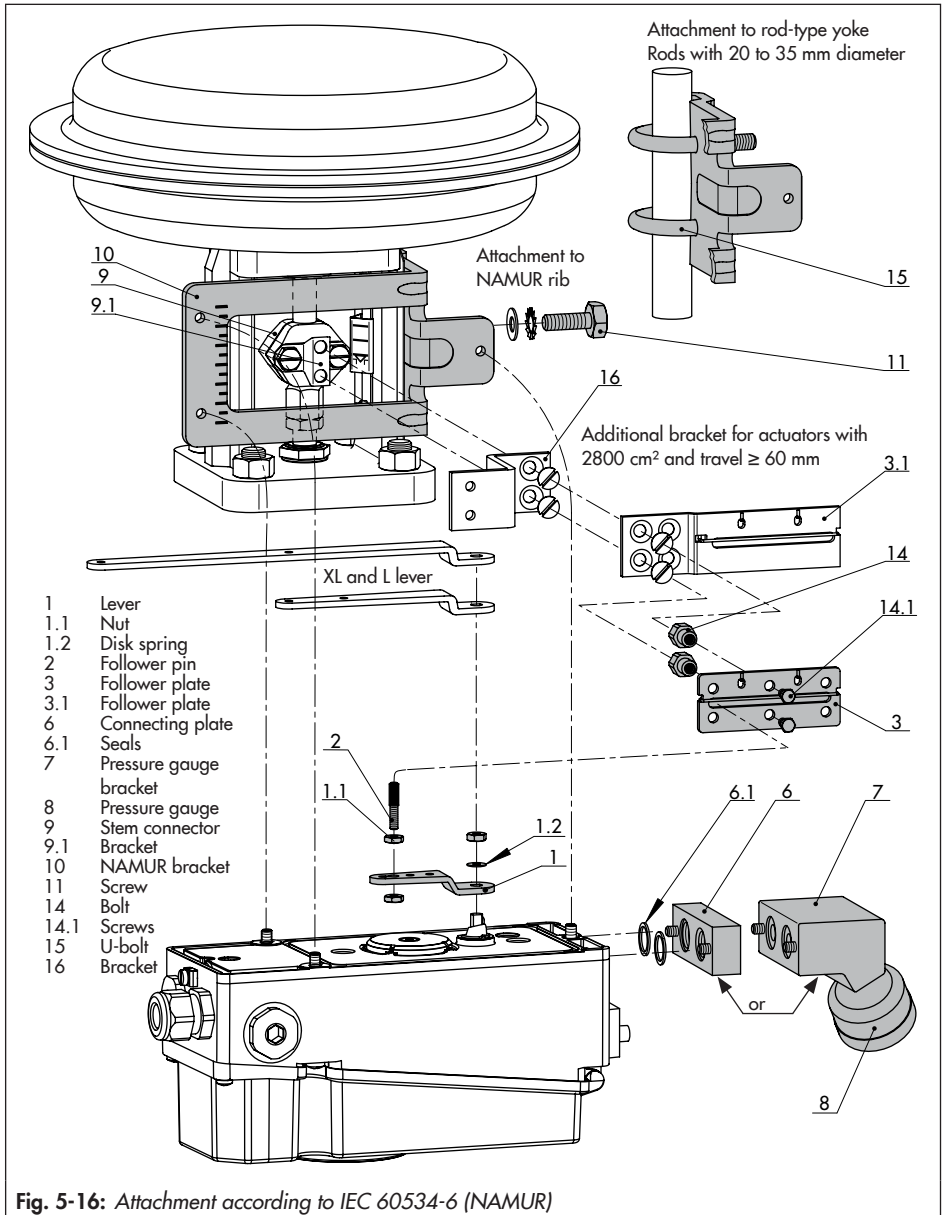

5.3.3 Attachment according to VDI/VDE 3847

Attachment according to VDI/VDE 3847 allows the positioner to be replaced quickly while the process is running by blocking the air in the actuator.

Note

This type of attachment is not recommended when two pneumatic modules are used as the connection block reduces the K_V coefficient.

Tip

To monitor the supply air and signal pressure, SAMSON recommends mounting pressure gauges (see Chapter 5.6).

a) Attachment to linear actuators (VDE/VDE 3847-1)

The positioner can be attached directly to linear actuators (Type 3277 Actuator) or according to IEC 60534-6 (NAMUR).

The actuator must be blocked in position before the positioner can be changed (see Fig. 5-17)

1. Unscrew the red retaining screw (20).
2. Turn the air blocker (19) on the bottom of the adapter block according to the inscription.

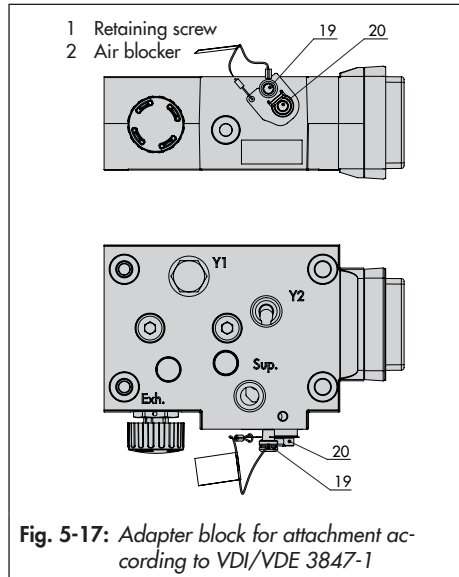
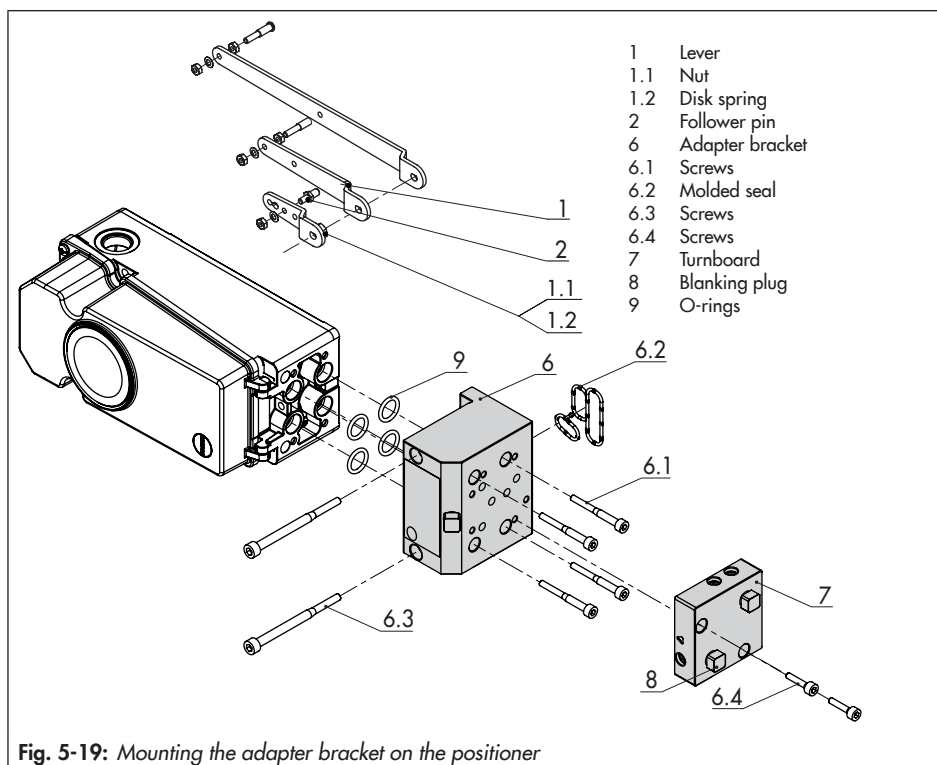
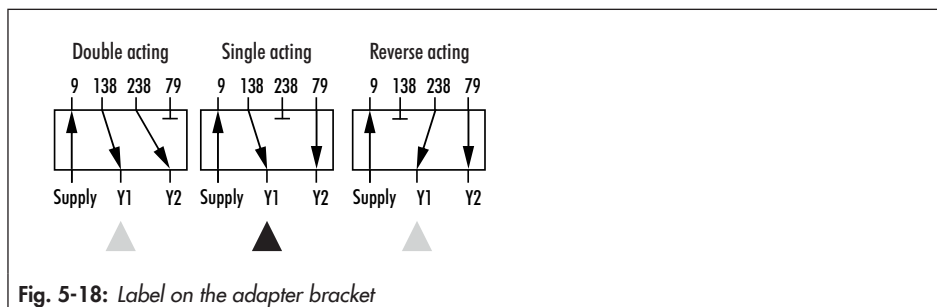

Fig. 5-17: Adapter block for attachment according to VDI/VDE 3847-1

Preparing the positioner for attachment

→ See Fig. 5-19

1. Unscrew the dummy plate (if installed) from the top pneumatic connections of the positioner.
2. Unfasten the turnboard (7) from the adapter bracket (6).
3. Place the adapter bracket (6) on the positioner and mount using the screws (6.1). Make sure that the O-rings are correctly seated.
4. Place the turnboard (7) on the adapter bracket (6). Make sure that the O-rings are correctly seated.
5. Select the required switching function from Fig. 5-18 by turning the turnboard: an arrow on the turnboard points to the



Installation

corresponding switching function (see Fig. 5-18).

6. Insert the molded seal (6.2) in the groove of the adapter bracket (6).
7. Select required lever size (1) M, L or XL and pin position according to the actuator size and valve travel (see travel tables on page 5-4).

Mounting the positioner

→ Required mounting parts and accessories: see Chapter 5.6, Table 5-8.

→ See Fig. 5-20

Mount the positioner on the yoke. The signal pressure is routed to the actuator over the connecting plate (12), for actuators with fail-safe action "actuator stem extends" internally through a bore in the valve yoke and for "actuator stem retracts" through external piping.

Only the Y1 port is required for positioner attachment. The Y2 port can be used for air purging of the spring chamber.

1. Place follower clamp (3) on the actuator stem, align it and screw tight so that the mounting screw is located in the groove of the actuator stem.
2. Insert the molded seal (17.1) into the turnboard (17) and mount the turnboard to the adapter block (13) using the screws (17.2).
3. Mount the dummy plate (18) to the turnboard (17) using the screws (18.1). Make sure that the seals are correctly seated.

i Note

A solenoid valve can also be mounted in place of the dummy plate (18). The orientation of the turnboard (17) determines the mounting position of the solenoid valve. Alternatively, a restrictor plate can be mounted (▶ AB 11).

4. Insert the screws (13.1) through the middle holes of the adapter block (13).
5. Place the connecting plate (12) together with the seal (12.1) onto the screws (13.1) corresponding to the fail-safe action "actuator stem extends" or "actuator stem retracts". The fail-safe action that applies is determined by aligning the groove of the adapter block (13) with the groove of the connecting plate (12).
6. Mount the adapter block (13) together with the connecting plate (12) to the actuator using the screws (13.1).
7. Insert the vent plug (11.1) into the **Exh.** connection.
8. For fail-safe action "actuator stem extends", seal the Y1 port with a blanking plug.
For fail-safe action "actuator stem retracts", connect the Y1 port to the signal pressure connection of the actuator.
9. Press the shaft lock of the prepared positioner (see Fig. 5-15, bottom left) and hold the lever in position 2.
10. Place positioner in such a manner that the follower pin (2) rests on the top of the

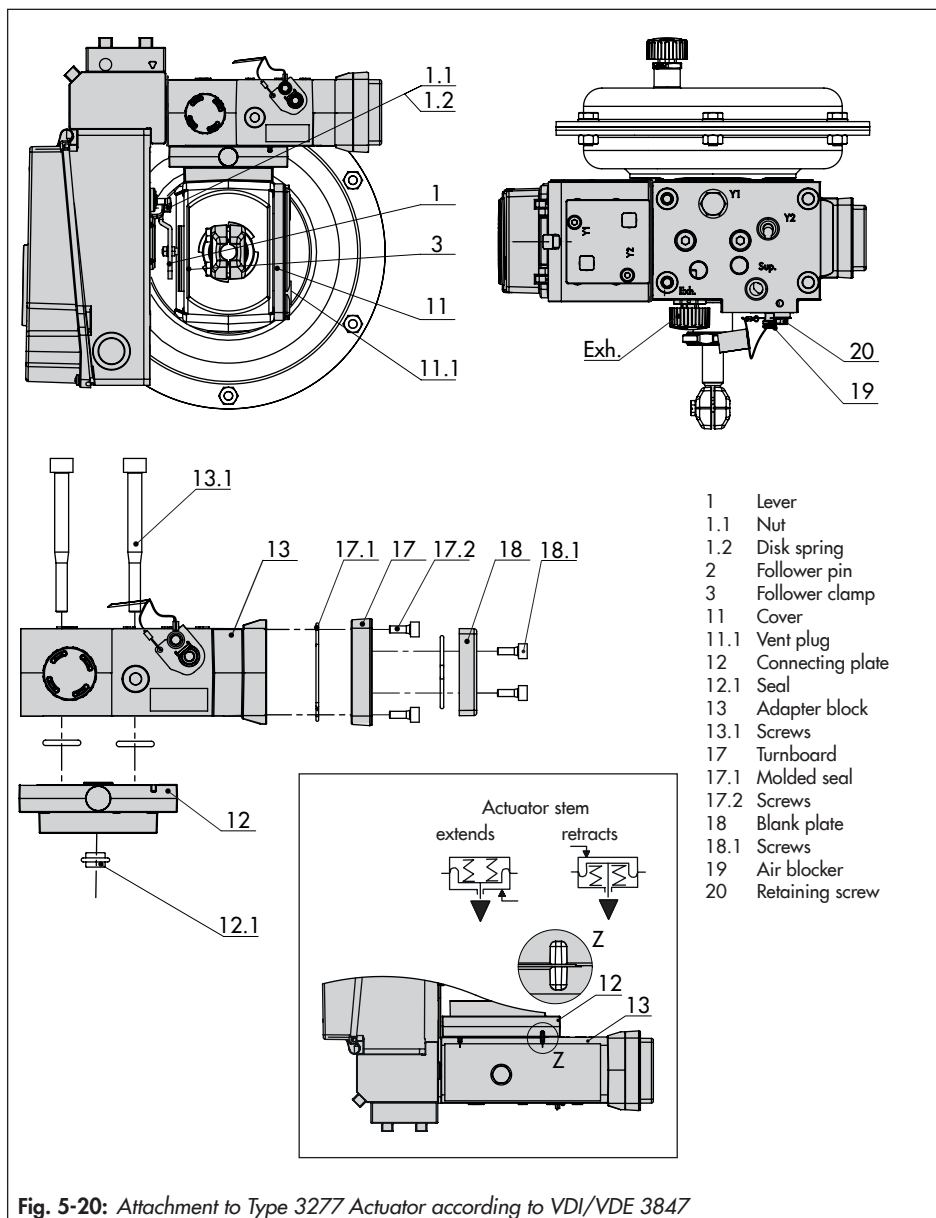

Fig. 5-20: Attachment to Type 3277 Actuator according to VDI/VDE 3847

follower clamp (3). The lever (1) must rest on the follower clamp with spring force.

11. Fasten the positioner to the adapter block (13) using the two fastening screws (6.3). Make sure the molded seal (6.2) is properly seated (see Fig. 5-20).

12. Mount cover (11) on the other side.

Make sure that the vent plug is located at the bottom when the control valve is installed to allow any condensed water that collects to drain off.

Attachment according to IEC 60534-6 (NAMUR)

→ Required mounting parts and accessories: see Chapter 5-40, Table 5-8.

→ Observe travel tables on page 5-4.

→ See Fig. 5-21

1. **Series 240 Valves, actuator size up to 1400-60 cm²:** Screw the two bolts (14) to the bracket of the stem connector or directly to the stem connector (depending on the version), place the follower plate (3) on top and use the screws (14.1) to fasten it.

Type 3251 Valve, 350 to 2800 cm²:

Screw the longer follower plate (3.1) to the bracket of the stem connector or directly to the stem connector (depending on the version).

Type 3254 Valve, 1400-120 to 2800 cm²:

Screw the two bolts (14) to the bracket (16). Fasten the bracket (16) onto the stem connector, place the follower plate (3) on top and use the screws (14.1) to fasten it.

2. For **attachment to the NAMUR rib**, fasten the NAMUR connection block (10) directly into the existing yoke bore using the screw and toothed lock washer (11). Align the marking on the NAMUR valve connection (on the side marked '1') to 50 % travel.

For attachment to **valves with rod-type yokes** using the formed plate (15), which is placed around the yoke: screw the four studs into the NAMUR connection block (10). Place the NAMUR connection block (10) on the rod and position the formed plate (15) on the opposite side. Use the nuts and toothed lock washers to fasten the formed plate onto the studs. Align the marking on the NAMUR valve connection (on the side marked '1') to 50 % travel.

3. Insert the molded seal (17.1) into the turnboard (17) and mount the turnboard to the adapter block (13) using the screws (17.2).

4. Mount the dummy plate (18) to the turnboard using the screws (18.1). Make sure that the seals are correctly seated.

i Note

A solenoid valve can also be mounted in place of the dummy plate (18). The orientation of the turnboard (17) determines the mounting position of the solenoid valve. Alternatively, a restrictor plate can be mounted (▶ AB 11).

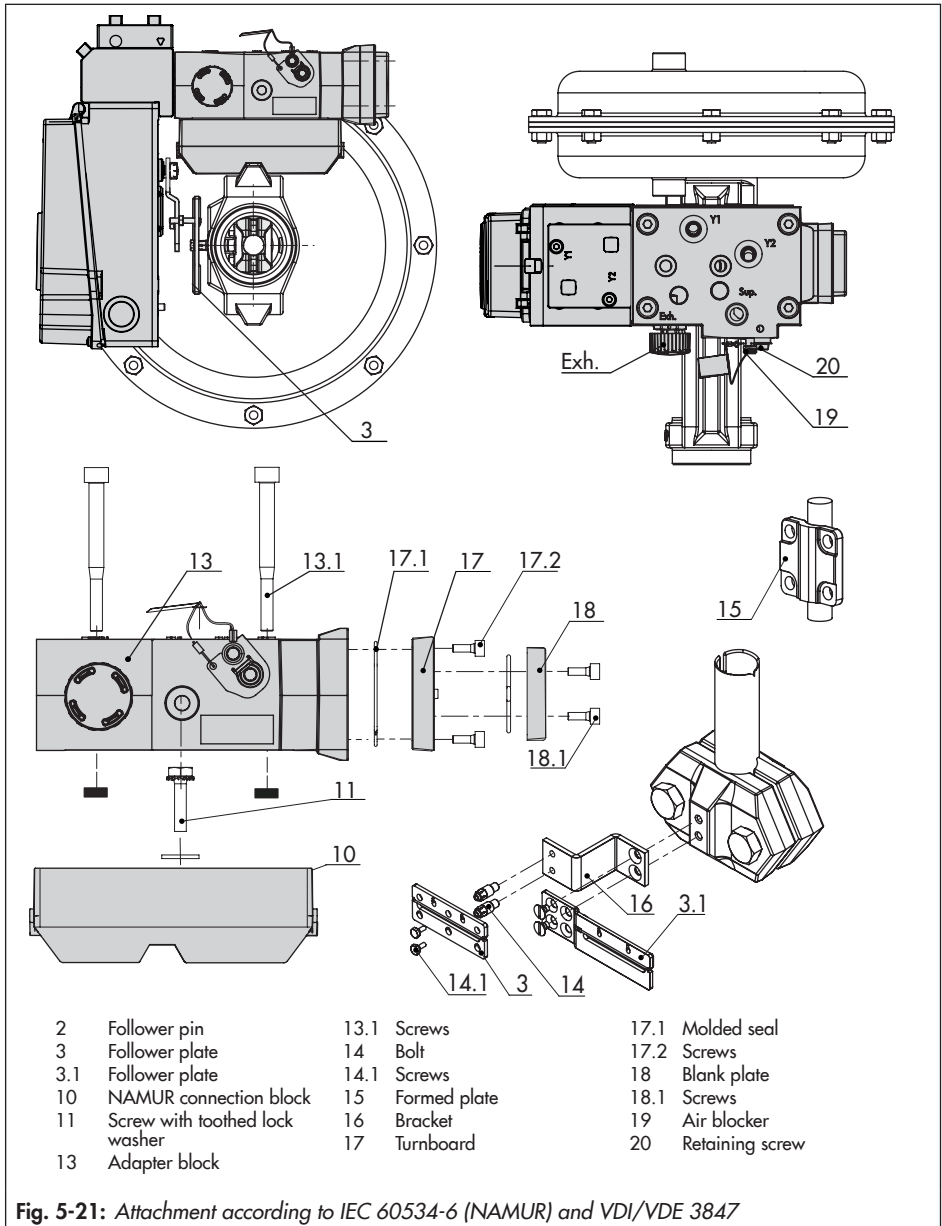

Installation

5. Fasten the adapter block (13) to the NAMUR connection block using the screws (13.1).
6. Insert the vent plug into the Exh. connection.
7. Place the positioner on the adapter block (13) in such a manner that the follower pin (2) rests on the top of the follower plate (3, 3.1). Adjust the lever (1) correspondingly.
8. Select required lever size (1) M, L or XL and pin position according to the actuator size and valve travel (see travel tables on page 5-4).
9. Fasten the positioner to the adapter block (13) using the two fastening screws (6.3). Make sure the molded seal (6.2) is properly seated.
10. For **single-acting actuators without air purging**, connect the Y1 port of the adapter block to the signal pressure connection of the actuator. Seal the Y2 port with a blanking plug.

For **double-acting actuators and actuators with air purging**, connect the Y2 port of the adapter block to the signal pressure connection of the second actuator chamber or spring chamber of the actuator. Seal the Exh. connection in the adapter block with a blanking plug.

b) Attachment to rotary actuators (VDI/VDE 3847-2)

The actuator must be blocked in position before the positioner can be changed (see Fig. 5-22)

1. Unscrew the red retaining screw (1).
2. Turn the air blocker (2) on the bottom of the adapter block according to the inscription.

Preparing the positioner for attachment

→ See Fig. 5-24

1. Unscrew the dummy plate (if installed) from the top pneumatic connections of the positioner.
2. Unfasten the turnboard (7) from the adapter bracket (6).
3. Place the adapter bracket (6) on the positioner and mount using the screws (6.1). Make sure that the O-rings are correctly seated.
4. Place the turnboard (7) on the adapter bracket (6). Make sure that the O-rings are correctly seated.
5. Select the required switching function from Fig. 5-23 by turning the turnboard: an arrow on the turnboard points to the corresponding switching function (see Fig. 5-18).
6. Take follower pin on the lever (M) out of its pin position and place in position 90°.

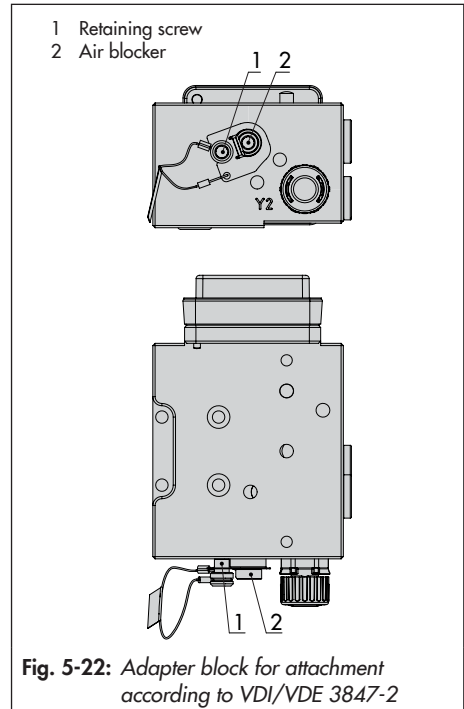

Fig. 5-22: Adapter block for attachment according to VDI/VDE 3847-2

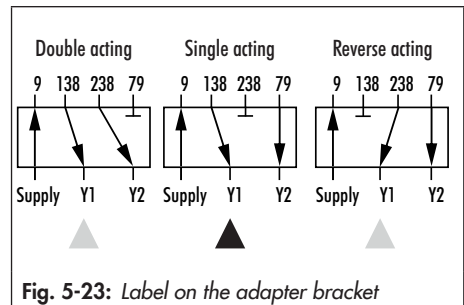
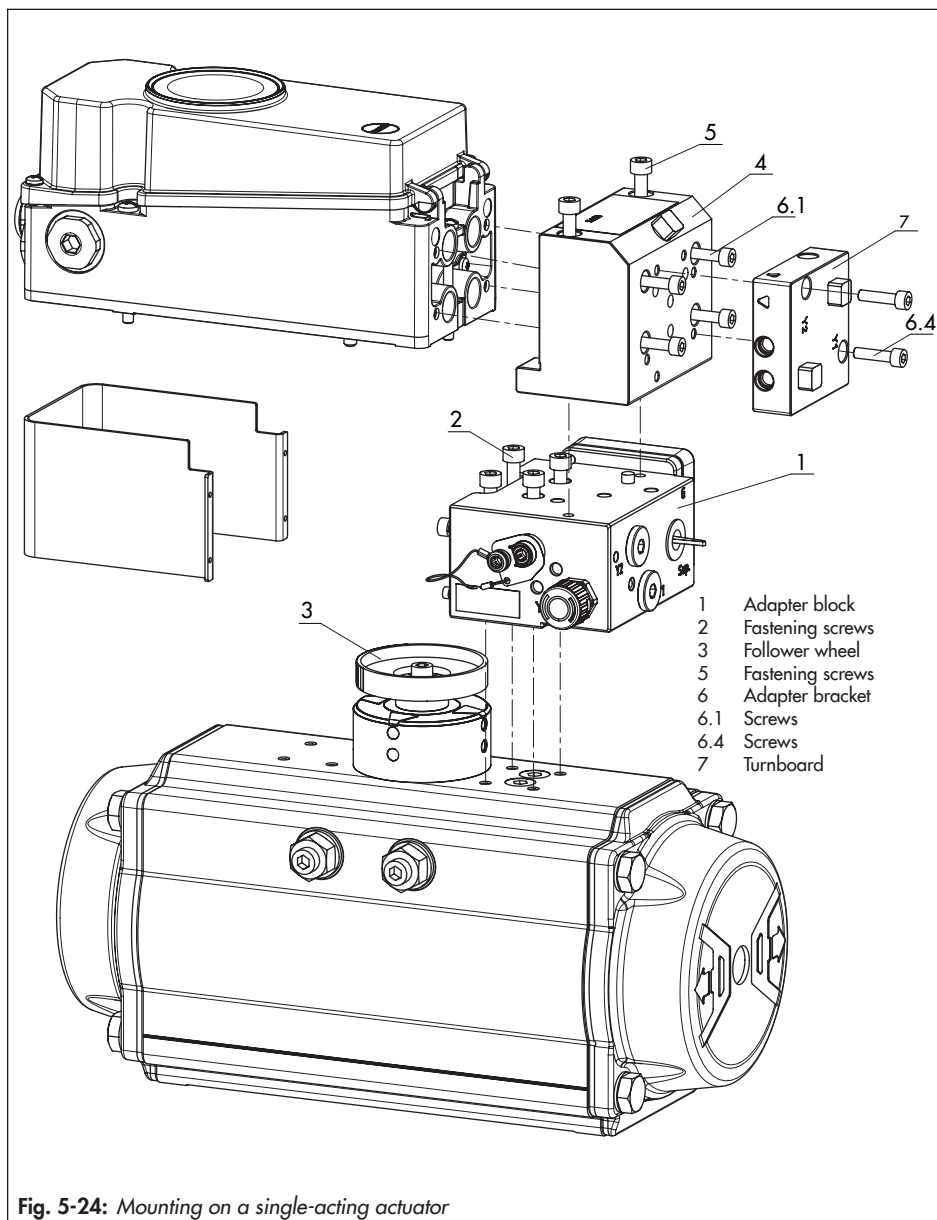

Fig. 5-23: Label on the adapter bracket

Installation

Mounting the positioner

- Required mounting parts and accessories: see Chapter 5.6, Table 5-9.
 - See Fig. 5-24
1. Fasten the adapter block (1) to the actuator's NAMUR interface using the four fastening screws (2). Make sure that the seals are correctly seated.
 2. Mount the follower wheel (3) onto the actuator shaft. Use the matching shaft adapter (see Chapter Table 5-9, 5.6).
 3. Place the adapter bracket (4) onto the adapter block (1) and fasten it using the fastening screws (5). Make sure that the seals are correctly seated.
 4. Insert and fasten the follower pin in the 90° position on the positioner's lever. Only use the longer follower pin included in the mounting kit.
 5. Align the positioner on the adapter bracket (1) in such a way that the follower pin engages into the actuator's follower wheel (3).
 6. Fasten the positioner onto the adapter bracket (6.4) using the fastening screws (6). Make sure that the seals are correctly seated.
 7. Fasten the protective cover between the actuator and positioner to enclose the follower wheel.



Installation

Mounting a solenoid valve

→ See Fig. 5-25

A solenoid valve (13) can also be mounted in place of the dummy plate (12). The orientation of the turnboard (14) determines the mounting position of the solenoid valve. Alternatively, a restrictor plate can be mounted. Further information can be found in the document ► AB 11 (Accessories for Solenoid Valves).

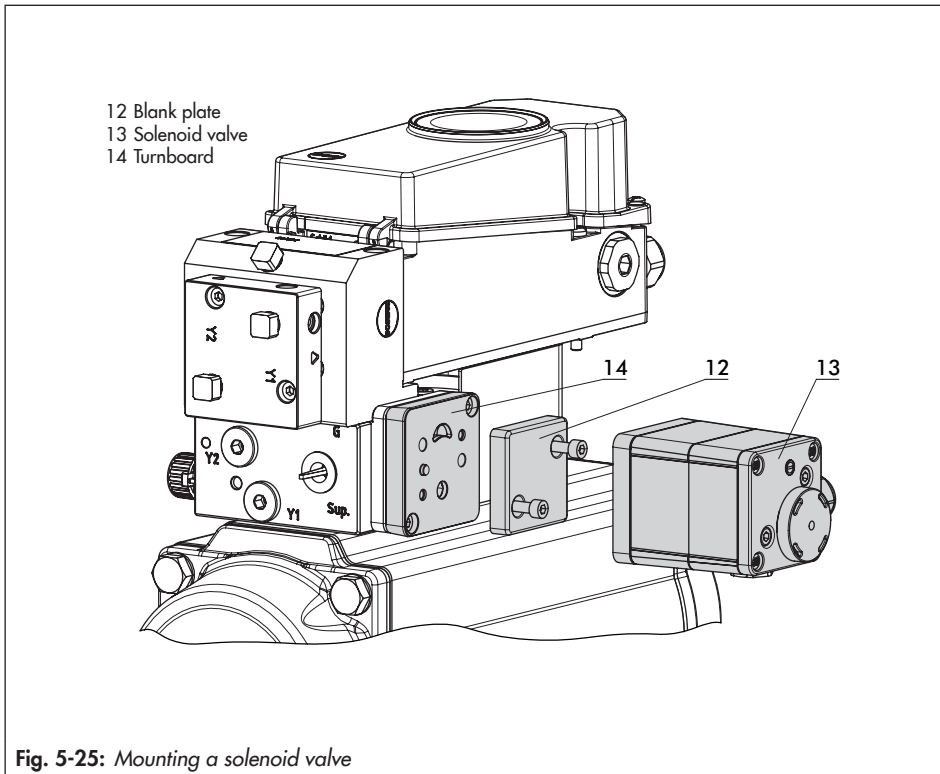

Fig. 5-25: Mounting a solenoid valve

5.3.4 Attachment according to VDI/VDE 3845 and to Type 3278, VETEC S160 and R

→ See Fig. 5-27

NOTICE

Risk of positioner damage due to incorrect direction of rotation of the rotary actuator.

→ Observe the actuator's direction of rotation on attaching the positioner as described below.

- Required mounting parts and accessories: see Chapter 5.6, Table 5-10.
 - Prepare actuator and mount possibly required adapter supplied by the actuator manufacturer.
1. Mount the housing (10) onto the rotary actuator. In case of VDI/VDE attachment, place spacers (11) underneath, if necessary. Details and dimensions for the fixing levels with VDI/VDE 3845 can be found in the 'Design and principle of operation' chapter.
 2. For **SAMSON Type 3278 and VETEC S160 Rotary Actuators**, fasten the adapter (5) onto the free end of the shaft and for VETEC R Actuator, place on the adapter (5.1). For Type 3278, VETEC S160 and VETEC R Actuators, place on the adapter (3). For VDI/VDE version, this step depends on the actuator size.
 3. Stick adhesive label (4.3) onto the coupling wheel in such a manner that the

yellow part of the sticker is visible in the window of the housing when the valve is OPEN (adhesive labels with explanatory symbols are enclosed and can be stuck on the housing, if required).

4. Fasten coupling wheel (4) on the slotted actuator shaft or adapter (3) using screw (4.1) and disk spring (4.2).
5. Unscrew the standard follower pin (2) from the positioner's M lever (1). Attach the follower pin (Ø5 mm) included in the mounting kit to pin position 90°.
6. Place positioner on housing (10) and screw it tight. Taking the actuator's direction of rotation into account, adjust lever (1) so that it engages in the correct slot with its follower pin (see Fig. 5-26).

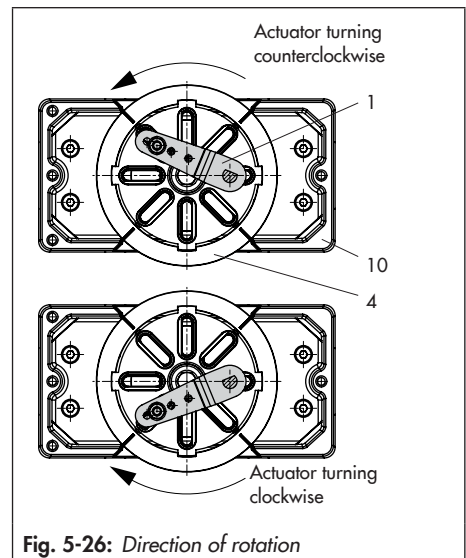

Installation

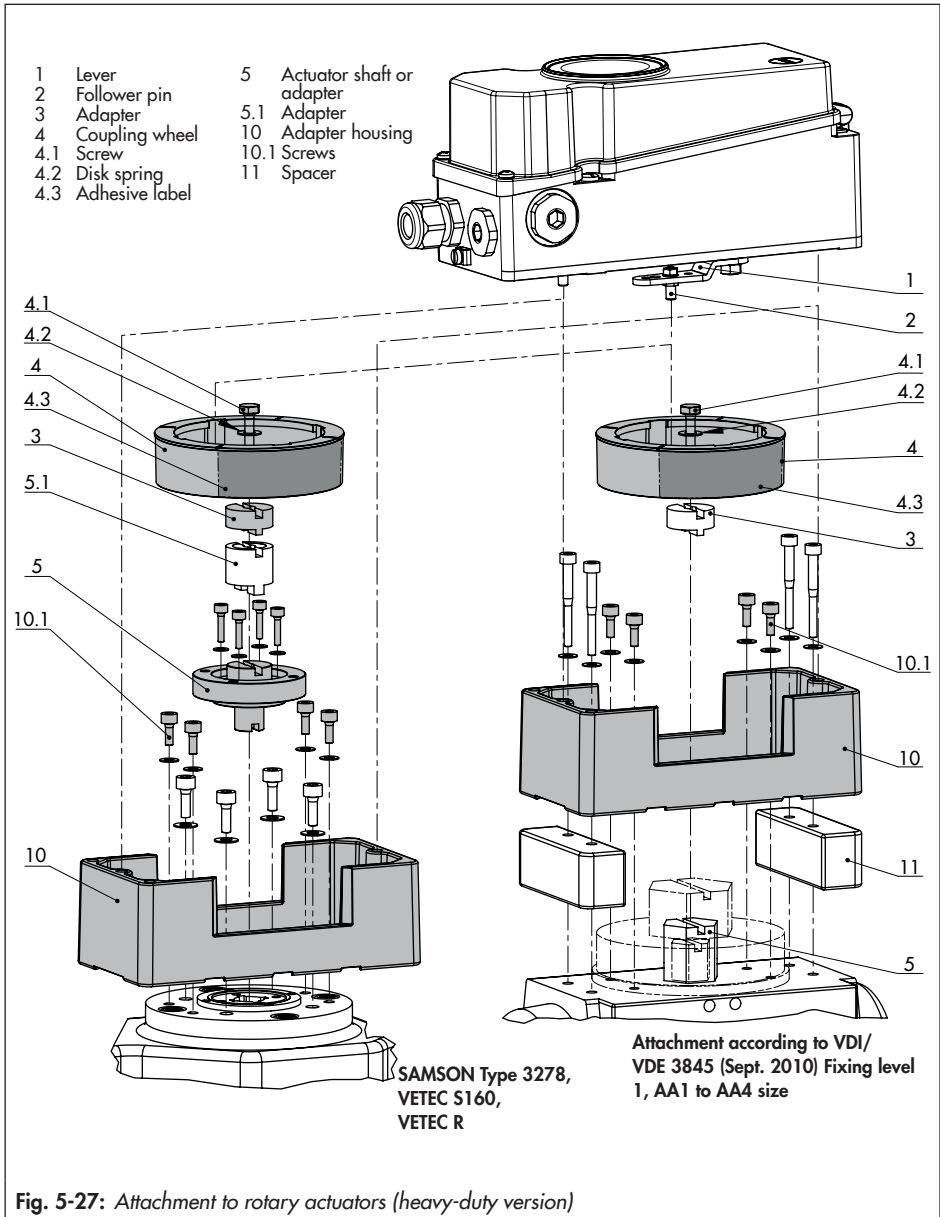

Fig. 5-27: Attachment to rotary actuators (heavy-duty version)

5.4 Pneumatic connection

NOTICE

Incorrect pneumatic connection will damage the positioner and lead to malfunction.

→ Screw the screw fittings into the connecting plate, pressure gauge mounting block or connection block from the accessories.

NOTICE

Risk of malfunction due to failure to comply with air quality requirements.

- Only use supply air that is dry and free of oil and dust.
- Read the maintenance instructions for upstream pressure reducing stations.
- Blow through all air pipes and hoses thoroughly before connecting them.

The four pneumatic outputs are located on the back of the positioner (see Fig. 5-28).

The availability of the Outputs 138 and 238 depends on the pneumatic module combination.

Note

If **one** pneumatic module is used, the entire air passage (screw fitting, pipe, mounting plate etc.) must have a minimum inside diameter of 5.9 mm.

If **two** pneumatic modules are used, the entire air passage (screw fitting, pipe, mounting plate etc.) must have a minimum inside diameter of 7 mm.

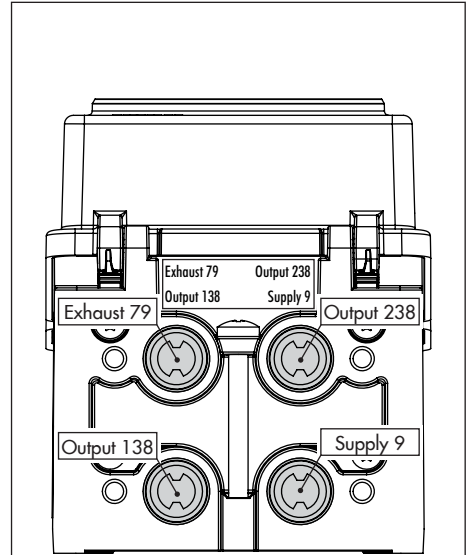

Fig. 5-28: Pneumatic outputs

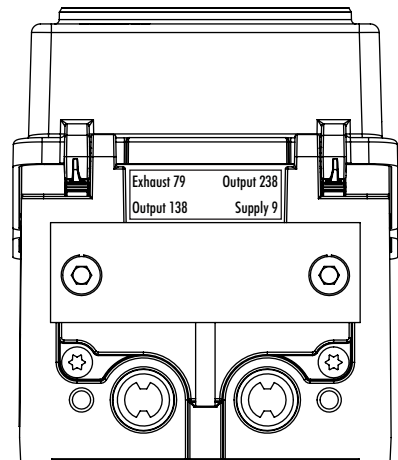

Fig. 5-29: Output 238 and Exhaust 79 sealed with dummy plate

We recommend using a larger inside diameter as the air capacity is further reduced by any turns and kinks in the air passage.

Connecting the supply air

Before performing the pneumatic connection, make sure the following conditions are met:

- The positioner is properly mounted onto the control valve.

If this is the case:

- Seal Output 238 and Exhaust 79 with a dummy plate (see Fig. 5-29) if only one pneumatic output is available.
- Perform the pneumatic connections in the connecting plate, pressure gauge mounting block and connection block (optionally designed as a bore with ¼ NPT or G ¼ thread). Customary fittings for metal or copper tubing or plastic hoses can be used.

5.4.1 Signal pressure connection

The signal pressure connection depends on how the positioner is mounted onto the actuator:

Type 3277 Actuator

- The signal pressure connection is fixed.

Attachment according to IEC 60534-6

- For "actuator stem retracts" fail-safe action: connect the signal pressure to the connection on top of the actuator.

- For "actuator stem extends" fail-safe action: connect the signal pressure to the connection on bottom of the actuator.

Rotary actuators (heavy-duty version)

- For rotary actuators, the manufacturer's specifications for connection apply.

5.4.2 Output pressure display

Tip

To monitor the supply air and signal pressure, SAMSON recommends mounting pressure gauges (see Chapter 5.6).

Mounting the pressure gauges:

- See Chapter 5.3.2 and Fig. 5-16

5.4.3 Supply pressure

The required supply air pressure depends on the bench range and the actuator's direction of action (fail-safe action).

The bench range is written on the nameplate either as the bench range or signal pressure range depending on the actuator. The direction of action is marked FA or FE or by a symbol.

Actuator stem extends FA (AIR TO OPEN)

Fail-close (for globe and angle valves):

- Required supply pressure = Upper bench range value + 0.2 bar, at least 2.5 bar.

Actuator stem retracts FE (AIR TO CLOSE)

Fail-open (for globe and angle valves):

For tight-closing valves, the maximum signal pressure p_{st_max} is roughly estimated as follows:

$$p_{st_{max}} = F + \frac{d^2 \cdot \pi \cdot \Delta p}{4 \cdot A} \text{ bar}$$

- d = Seat diameter (cm)
- Δp = Differential pressure across the valve (bar)
- A = Actuator area in cm²
- F = Upper bench range value of the actuator (bar)

If there are no specifications, calculate as follows:

→ Required supply pressure = Upper bench range value + 1 bar, at least 2.5 bar.

5.4.4 Typical applications and hook-ups

Typical applications and hook-ups of the TROVIS 3797 Positioner are listed below. Besides mounting the positioner onto a pneumatic actuator, the possible combinations of pneumatic modules must be taken into account. The permissible possible combinations listed in Fig. 5-7 apply in this case.

Typical application with single-acting actuators

The signal at output 138 is used to control a single-acting pneumatic actuator. The outputs 238 and 79 are sealed (see Fig. 5-29). The air capacity can be doubled by using two pneumatic modules.

In this case, the positioner is fitted with the following pneumatic modules:

Combination	Slot A	Slot B	Air capacity
Combination 1	P3799-0001 module (single and double acting)	P3799-0000 module (dummy module)	K _{Vs} 0.35
Combination 2	P3799-0001 module (single and double acting)	P3799-0001 module (single and double acting)	K _{Vs} 0.70

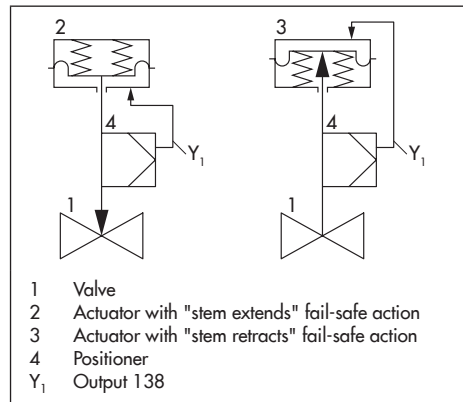

Installation

Typical application with double-acting actuator

The two outputs of the positioner are used to control a double-acting pneumatic actuator. Output 79 is sealed by a blanking plug. The output 138 is vented and the output 238 is supplied with air during fail-safe action. The air capacity can be doubled by using two pneumatic modules.

In this case, the positioner is fitted with the following pneumatic modules:

Combination	Slot A	Slot B	Air capacity
Combination 1	P3799-0001 module (single and double acting)	P3799-0000 module (dummy module)	$K_{VS} 0.35$
Combination 2	P3799-0001 module (single and double acting)	P3799-0001 module (single and double acting)	$K_{VS} 0.70$

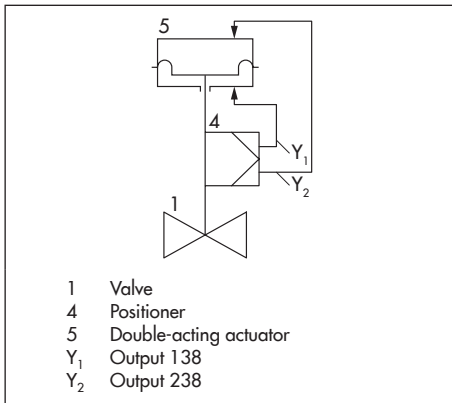

Single-acting with air purging of the actuator's spring chamber

The signal at output 138 is used to control a single-acting pneumatic actuator. The actuator's spring chamber is additionally purged with instrument air over the output 79 (Exhaust) of the positioner to protect the inside of the actuator against corrosion. Output 238 must be sealed by a blanking plug. The air capacity can be doubled by using two pneumatic modules.

In this case, the positioner is fitted with the following pneumatic modules:

Combination	Slot A	Slot B	Air capacity
Combination 1	P3799-0001 module (single and double acting)	P3799-0000 module (dummy module)	$K_{VS} 0.35$
Combination 2	P3799-0001 module (single and double acting)	P3799-0001 module (single and double acting)	$K_{VS} 0.70$

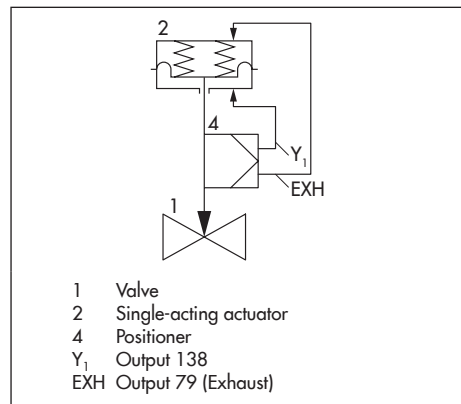

Large-signal/small-signal mode

Large-signal/small-signal mode can be used when faster actuating times with a high control accuracy are required. In this case, a small signal is supplied directly to the actuator over output 138. For large step changes, output 238 of the positioner is used to pass on the signal to one or more valve accessories (e.g. volume booster). Output 79 is used for air purging of the actuator's spring chamber or can be sealed by a blanking plug.

Advantages of this model include:

- Short actuating times
- Less overshooting
- Shorter settling times
- Smaller set point deviation
- Larger and faster steps
- Exact control for small step changes

The use of the large-signal/small-signal mode is only possible with single-acting actuators. In this case, the positioner is fitted with the following pneumatic modules:

Combination	Slot A	Slot B	Air capacity
Combination 3	P3799-0002 module (single acting)	P3799-0003 module (single acting)	K_{Vs} 0.35

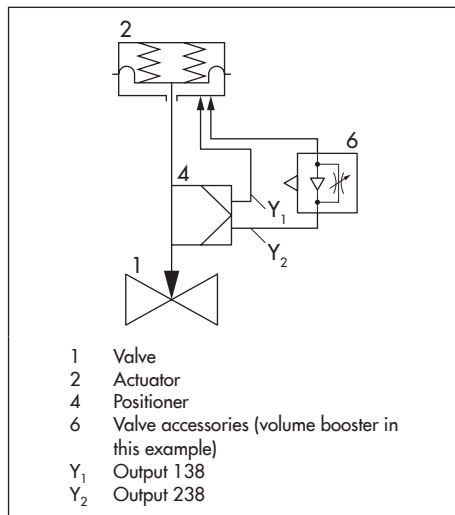

5.5 Electrical connection

⚠ WARNING

Incorrect electrical connection will render the explosion protection unsafe.

- Do not undo the enameled screws.
- Do not exceed the maximum permissible values specified in the EC type examination certificates when interconnecting intrinsically safe electrical equipment (U_i or U_{o_i} , I_i or I_{o_i} , P_i or P_{o_i} , C_i or C_o and L_i or L_o).

The positioner is powered over the Ethernet-APL connection. **No other** current or voltage source is required.

Installation

Selecting cables and wires

- Observe the relevant clauses of EN 60079-14 for installation of intrinsically safe circuits.
- Seal cable entries left unused with plugs.
- Fit equipment used in ambient temperatures below $-20\text{ }^{\circ}\text{C}$ with metal cable entries.

The wires are connected using screw terminals (terminal $-/+$) with a wire cross-section from 0.2 to 2.5 mm^2 . The tightening torque is 0.5 to 0.6 Nm .

Cable entry with cable gland

The enclosure of the positioner has four threaded boreholes, which can be fitted with cable glands as required.

- The cable gland version depends on the ambient temperature range (see technical data in the 'Design and principle of operation' chapter).
- See Chapter 5.6 for available cable glands.
- The screw terminals are designed for wire cross-sections of 0.2 to 2.5 mm^2 (tightening torque 0.5 Nm).

If connection over an equipotential bonding conductor is required, it can be connected inside or outside of the device.

Supplying the positioner with energy

Before performing the pneumatic connection, make sure the following conditions are met:

- The positioner is properly mounted onto the control valve.
- The air supply is properly connected.

If this is the case:

- Connect the positioner to Ethernet-APL by inserting the connector of the two-wire Ethernet cable into the port intended for it on the positioner.

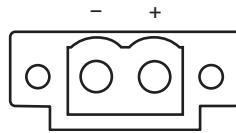

Fig. 5-30: Port for Ethernet-APL connection (2-WISE according to EN IEC 60079-0: 2018, EN 60079-11:2012 and TS IEC 60079-47)

Z3799-xxx15 [P] · Inductive limit contacts and binary output (NAMUR)									
Slot	Terminal assignment								
D	<table border="1"> <thead> <tr> <th>Description</th> <th>Terminal</th> </tr> </thead> <tbody> <tr> <td>Binary output (NAMUR)</td> <td>P +83 -84</td> </tr> <tr> <td>Inductive limit contact 1</td> <td>P +41 -42</td> </tr> <tr> <td>Inductive limit contact 2</td> <td>P +51 -52</td> </tr> </tbody> </table> <p>The diagram shows three terminal blocks, each with two terminals. The connections are as follows:</p> <ul style="list-style-type: none"> Block 1: Terminal 1 (top) connects to +83; Terminal 2 (bottom) connects to -84. Block 2: Terminal 1 (top) connects to +41; Terminal 2 (bottom) connects to -42. Block 3: Terminal 1 (top) connects to +51; Terminal 2 (bottom) connects to -52. 	Description	Terminal	Binary output (NAMUR)	P +83 -84	Inductive limit contact 1	P +41 -42	Inductive limit contact 2	P +51 -52
Description	Terminal								
Binary output (NAMUR)	P +83 -84								
Inductive limit contact 1	P +41 -42								
Inductive limit contact 2	P +51 -52								
<p>NOTICE! Do not insert the module into slot C. The option module will be damaged.</p>									

5.6 Mounting accessories

Table 5-5: *General accessories*

Designation	Order no.	
Aluminum dummy plate for pneumatic connections	1402-1079	
Stainless steel dummy plate for pneumatic connections	1402-1438	
M20x1.5 cable gland	Black plastic (6 to 12 mm clamping range)	8808-1011
	Blue plastic (6 to 12 mm clamping range)	8808-1012
	Nickel-plated brass (6 to 12 mm clamping range)	1890-4875
	Nickel-plated brass (10 to 14 mm clamping range)	1992-8395
	Stainless steel 1.4305 (8 to 14.5 mm clamping range)	8808-0160
Adapter M20x1.5 to ½ NPT	Powder-coated aluminum	0310-2149
	Stainless steel	1400-7114
M lever	0510-0510	
L lever	0510-0511	
XL lever	0510-0512	
XXL lever	0510-0525	
TROVIS-VIEW 6661 (download available: ► www.samsongroup.com > DOWNLOADS > Software & Drivers > TROVIS-VIEW)		
Isolated USB interface adapter (SAMSON SSP interface to USB port on a computer)	1400-9740	
Set of spare parts, consisting of: 2x Molded seal for pneumatic interface 4x Filter 2x Cover hinge clip	1402-1582	

Table 5-6: Direct attachment to Type 3277 Actuator

Mounting parts/accessories	Order no.	
Std. mounting kit for direct attachment to actuators (175, 240, 350, 355, 700, 750 cm ²)	1400-7453	
Connection block with seals and screw	G ¼	1400-8819
	¼ NPT	1402-0901
Pressure gauge mounting kit up to max. 6 bar (output/supply)	Stainless steel/brass	1402-0938
	Stainless steel/stainless steel	1402-0939
Piping with screw fittings ¹⁾	Order no.	
Actuator (175 cm ²), steel	G ¼/G ¾	1402-0970
	¼ NPT/¾ NPT	1402-0976
Actuator (175 cm ²), stainless steel	G ¼/G ¾	1402-0971
	¼ NPT/¾ NPT	1402-0978
Actuator (240 cm ²), steel	G ¼/G ¾	1400-6444
	¼ NPT/¾ NPT	1402-0911
Actuator (240 cm ²), stainless steel	G ¼/G ¾	1400-6445
	¼ NPT/¾ NPT	1402-0912
Actuator (350 cm ²), steel	G ¼/G ¾	1400-6446
	¼ NPT/¾ NPT	1402-0913
Actuator (350 cm ²), stainless steel	G ¼/G ¾	1400-6447
	¼ NPT/¾ NPT	1402-0914
Actuator (355 cm ²), steel	G ¼/G ¾	1402-0972
	¼ NPT/¾ NPT	1402-0979
Actuator (355 cm ²), stainless steel	G ¼/G ¾	1402-0973
	¼ NPT/¾ NPT	1402-0980
Actuator (700 cm ²), steel	G ¼/G ¾	1400-6448
	¼ NPT/¾ NPT	1402-0915
Actuator (700 cm ²), stainless steel	G ¼/G ¾	1400-6449
	¼ NPT/¾ NPT	1402-0916
Actuator (750 cm ²), steel	G ¼/G ¾	1402-0974
	¼ NPT/¾ NPT	1402-0981
Actuator (750 cm ²), stainless steel	G ¼/G ¾	1402-0975
	¼ NPT/¾ NPT	1402-0982

¹⁾ For "actuator stem retracts" direction of action; with air purging of the top diaphragm chamber; air purging of the spring chamber for "actuator stem extends" direction of action

Installation

Table 5-7: Attachment to NAMUR rib or attachment to rod-type yokes ¹⁾ acc. to IEC 60534-6

Travel in mm	Lever	For actuator	Order no.
7.5	S	Type 3271-5 with 60/120 cm ² on Type 3510 Micro-flow Valve	1402-0478
5 to 50	M ²⁾	Actuators from other manufacturers and Type 3271 (240 to 750 cm ²)	1400-7454
14 to 100	L	Actuators from other manufacturers and Type 3271 (1000 and 1400-60 cm ²)	1400-7455
30 or 60	L	Type 3271 (1400-120 and 2800 cm ² with 30/60 mm travel)	1400-7466
		Mounting brackets for Emerson and Masoneilan linear actuators (in addition, a mounting kit according to IEC 60534-6 is required depending on the travel). See rows above.	1400-6771
		Valtek Type 25/50	1400-9554
40 to 200	XL	Actuators from other manufacturers and Type 3271 (1400-120 and 2800 cm ² with 120 mm travel)	1400-7456
60 to 300	XXL	Actuators from other manufacturers and Type 3271 (1400-250 with 250 mm travel)	1402-0806
Accessories			Order no.
Connecting plate, aluminum		G ¼	1402-1434
		¼ NPT	1402-1435
Connecting plate, stainless steel		G ¼	1402-1436
		¼ NPT	1402-1437
Pressure gauge bracket, two pressure gauges, aluminum		G ¼	1402-1599
		¼ NPT	1402-1600
Pressure gauge bracket, two pressure gauges, stainless steel		G ¼	1402-1601
		¼ NPT	1402-1602
Pressure gauge bracket, three pressure gauges, aluminum		G ¼	1402-1578
		¼ NPT	1402-1579
Pressure gauge bracket, three pressure gauges, stainless steel		G ¼	1402-1580
		¼ NPT	1402-1581
Pressure gauge mounting kit, with two pressure gauges up to 6 bar		Stainless steel/brass	1402-0938
		Stainless steel/stainless steel	1402-0939
Pressure gauge mounting kit, with two pressure gauges up to 10 bar			1402-1583
Pressure gauge mounting kit, with three pressure gauges up to 10 bar			1402-1528

¹⁾ 20 to 35 mm rod diameter

²⁾ M lever is mounted on basic device (included in the scope of delivery)

Table 5-8: Attachment according to VDI/VDE 3847-1

Mounting parts	Order no.
Interface adapter ¹⁾ VDI/VDE 3847 for TROVIS 3797	1402-1527
Pressure gauge mounting kit, with three pressure gauges up to 10 bar	1402-1528
Mounting kit for attachment to SAMSON Type 3277 Actuator with 175 to 750 cm ²	1402-0868
Mounting kit for attachment to SAMSON Type 3271 Actuator or third-party actuators	1402-0869
Travel pick-off for valve travel up to 100 mm	1402-0177
Travel pick-off for 100 to 200 mm valve travel (SAMSON Type 3271 Actuator only)	1402-0178

¹⁾ Alternatively, the interface adapter (1402-0257) for Series 3730 Positioners can be used for mounting the TROVIS 3797 Positioner. The following restrictions apply on using it:

- Air purging of the actuator's spring chamber is not possible.
- Only single-acting function can be implemented.
- The top outputs (79 and 238, see Chapter 5.4) must be sealed with the dummy plate.

Table 5-9: Attachment according to VDI/VDE 3847-2

Designation	Order no.	
Mounting parts	Mounting block for PFEIFFER Type 31 a (edition 2020+) Rotary Actuators with dummy plate for solenoid valve interface	1402-1645
	Dummy plate for solenoid valve interface (sold individually)	1402-1290
	Adapter bracket (VDI/VDE 3847)	1402-1527
Accessories for actuator	Shaft adapter AA1	1402-1617
	Shaft adapter AA2	1402-1616
	Shaft adapter AA4	1402-1888

Table 5-10: Attachment to rotary actuators

Mounting parts/accessories		Order no.	
Attachment according to VDI/VDE 3845 (September 2010), actuator surface corresponds to fixing level 1			
Size AA1 to AA4, heavy-duty version		1400-9244	
Size AA5, heavy-duty version (e.g. AIR TORQUE 10 000)		1400-9542	
Bracket surface corresponds to fixing level 2, heavy-duty version		1400-9526	
Attachment to SAMSON Type 3278 (160 cm ²) and to VETEC Type S160, Type R and Type M, heavy-duty version		1400-9245	
Attachment to SAMSON Type 3278 (320 cm ²) and to VETEC Type S320, heavy-duty version		1400-5891 and 1400-9526	
Attachment to Camflex II		1400-9120	
Accessories	Connecting plate, aluminum	G 1/4	1402-1434
		1/4 NPT	1402-1435
	Connecting plate, stainless steel	G 1/4	1402-1436
		1/4 NPT	1402-1437
	Pressure gauge bracket, two pressure gauges, aluminum	G 1/4	1402-1599
		1/4 NPT	1402-1600
	Pressure gauge bracket, two pressure gauges, stainless steel	G 1/4	1402-1601
		1/4 NPT	1402-1602
	Pressure gauge bracket, three pressure gauges, aluminum	G 1/4	1402-1578
		1/4 NPT	1402-1579
	Pressure gauge bracket, three pressure gauges, stainless steel	G 1/4	1402-1580
		1/4 NPT	1402-1581
	Pressure gauge mounting kit, with two pressure gauges up to 6 bar	Stainless steel/brass	1402-1637
		Stainless steel/stainless steel	1402-1638
Pressure gauge mounting kit, with two pressure gauges up to 10 bar		1402-1583	
Pressure gauge mounting kit, with three pressure gauges up to 10 bar		1402-1528	

6 Operation

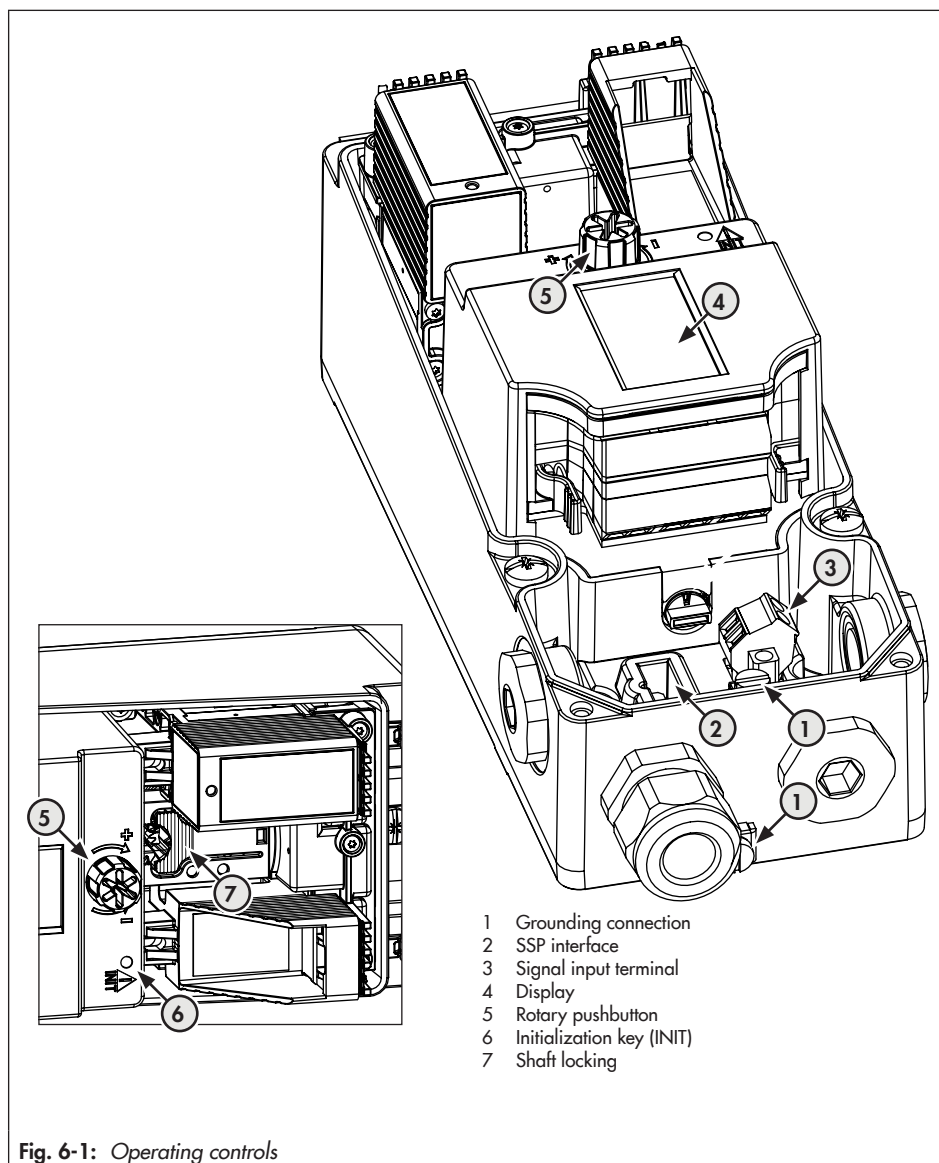





Fig. 6-1: Operating controls

6.1 Rotary pushbutton

The rotary pushbutton for on-site operation is located next to the display (right or left, depending on the mounting position).

-  Turn: select menu item, parameters or values.
-  Press: confirm selection.
-  Keep pressed down for two seconds: return to menu level (*ESC* with progress bar appears).

6.2 Initialization key (INIT)

WARNING

Crush hazard arising from actuator and plug stem moving.

- *Do not insert hands or finger into the yoke while the air supply is connected to the positioner.*
- *Do not impede the movement of the actuator and plug stem by inserting objects into the yoke.*

NOTICE

The process is disturbed by the movement of the actuator or valve.

Do not perform the initialization while the process is running. First isolate the plant by closing the shut-off valves.

For normal operation, simply start initialization by pressing the INIT key after mounting the positioner on the valve. In this case, the initialization is performed using the MAX initialization mode with ATO fail-safe position (see the 'Start-up and configuration' chapter). Additionally, the default settings in the parameter list (see configuration instructions in Appendix A) apply.

Proceed as follows for fast initialization:

1. Mount the positioner on the valve.
2. Connect the supply air.
3. Connect the electrical power.

→ During the first start-up, the wizard is displayed.

4. Use a thin object to press the initialization key (INIT).

6.3 Display



i Note

The display's operating range is from -30 to $+65$ °C. The readability of the display is restricted outside this temperature range.

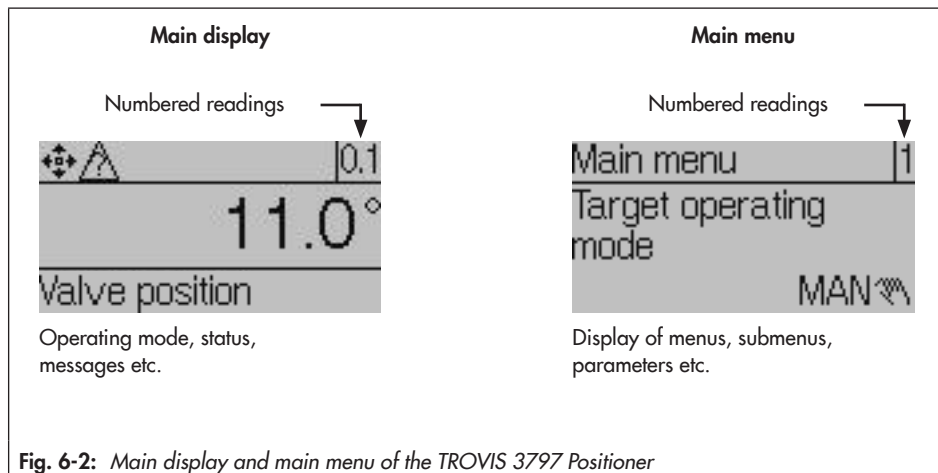
As soon as the positioner is powered over the Ethernet-APL connection, the wizard is displayed during the first start-up and, in all other cases, the main display (Fig. 6-2, left) appears, which is marked by the reading number 0.1 to 0.99 (at the top right-hand corner of the display). Displayed icons provide information on the operating mode, status etc. (see Chapter 6.3.2). Press the \otimes key to go from the main display to the menu level (Fig. 6-2, right). All settings can be made and functions executed in the menu level. The 'Start-up and configuration' chapter contains a description of the basic start-up settings. A list of the menu structure and parameters for on-site operation is included in Appendix A (configuration instructions).













Operation

- Turn  clockwise to scroll through from reading 0.1 to 0.99. Readings 0.0 to 0.99 are hidden or shown depending on the positioner's operating mode, configuration, status etc.
- Press  to go from the **main display** to the **menu level**.







6.3.1 Menu structure

The following menu structure contains the parameters and main folders. The folders are named correspondingly. The readings shown for individual parameters and folders depend on the state of the positioner (initialized or not yet initialized) and hardware and software configuration of the positioner (e.g. installed pneumatic modules, parameter settings). Appendix A (configuration instructions) contains a full list of all parameters that can appear on the display.

Main display

	Valve position in degrees
	Valve position in %
	Set point in %
	Set point deviation in %
	Supply pressure in bar
	Status of pneumatic module in slot A ¹⁾
	Status of pneumatic module in slot B ¹⁾
	Messages ²⁾
	Press  to go the main menu.

Main menu



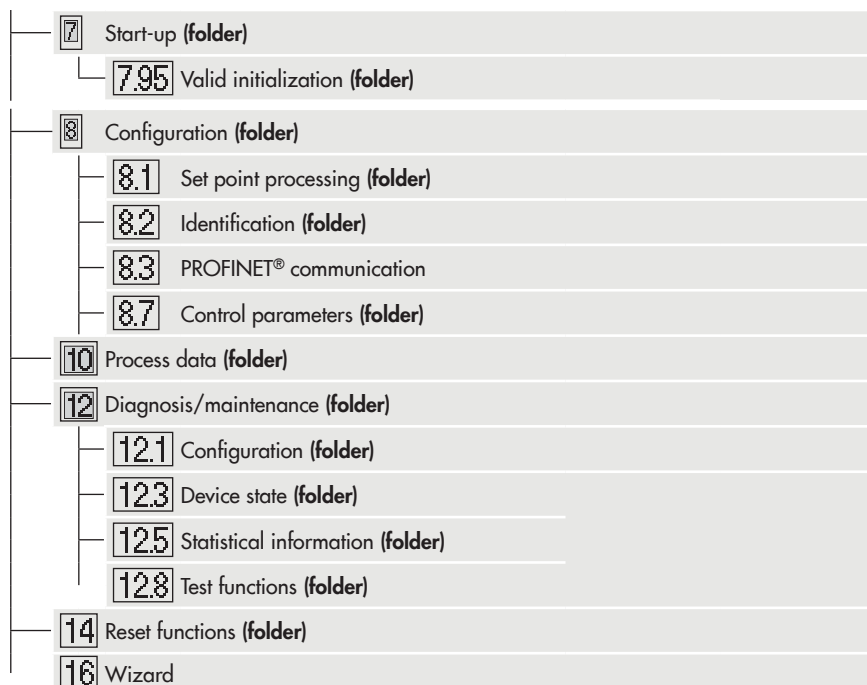



	Target operating mode
	Set point (open-loop control)
	Manual set point (MAN)
	Reason for fail-safe position
	Change reading direction
	User level



- 1) Reading only in the event of an error
- 2) Some of the messages can be confirmed: in this case, select the message and press  (only possible when the configuration is enabled, see the 'Start-up and configuration' chapter).

6.3.2 Display icons

Table 6-1: *Operating modes*

Icon	Operating mode	Description
	Automatic mode	The positioner is in closed-loop operation and follows the control signal.
	Automatic mode with communication with the process control system	The positioner is in closed-loop operation and communicates with the process control system.
	Manual mode	The positioner follows the manual set point instead of the control signal.
	SAFE (fail-safe position)	The pneumatic outputs of the positioner are either vented or supplied with air depending on the combination of the pneumatic modules.
	Open-loop control mode ¹⁾	The open-loop control mode allows the valve position to be adjusted manually (even when the positioner has not been initialized).
	Function mode	The positioner is being initialized or a test is in progress.

¹⁾ The open-loop control mode cannot be directly selected. It acts the same as the manual mode when the positioner has not yet been initialized.

Table 6-2: *NAMUR status*















Icon	Meaning
	Failure
	Function check
	Out of specification
	Maintenance demanded
	OK (no message)

Table 6-3: Other icons

Icon	Meaning
	Write protection
	Option installed in Slot C
	Option installed in Slot D
	Binary contact 1 active
	Binary contact 2 active
	Binary contact 3 active

6.3.3 Changing the reading direction of the display

The reading direction of the display can be adapted to the mounting situation (turned 180°) at any time.

1. Press  (in start screen) to go to the main menu.
2. Turn  until 'Change reading direction [5]' appears.
3. Press  to change reading direction.

6.4 PROFINET® communication

Note

*If complex functions are started in the positioner, which require a long calculation time or lead to a large quantity of data being saved in the volatile memory of the positioner, the alert 'busy' is issued by the configuration tool (e.g. FDI). This alert is **not an error message** and can be simply confirmed.*

6.4.1 GSD files

To integrate the positioner into the bus system, the PROFINET system must describe the positioner parameters, such as output and input data as well as data format and quantity. The GSD file contains configuration data, parameters, modules, diagnostics and alarms as well as the manufacturer and device ID. The GSD file has the XML file format and is created in the data description language GSDML.

A PROFINET General Station Description-(GSD) file describes an IO device provided by the device manufacturer. Configuration data, parameters, modules, diagnostics and alarms as well as the manufacturer and device ID contained in the GSD file. The manufacturer ID (Vendor ID) is a unique number assigned by PI (PROFIBUS & PROFINET International) to each manufacturer. Furthermore, the device manufacturer assigns a device ID for unique identification of each device family.

GSDML

Originally, PROFIBUS GSD files were ASCII text files with language-based extensions (GSD for German files and GSE for English files). In contrast, PROFINET uses XML as the data description language, which enables a data structure and numerous languages to be used. The PROFINET GSD file is termed "GSDML2 since it is written in XML format and has XML as the file extension. The GSD file for the positioner is structured as follows:

GSDML	- V2.42	- SAMSON	- TROVIS3797	- 20220420
Data description language	Specification version	Manufacturer	Product information	Date of issue yyyymmdd

Device description file

Device ID	
Profile	0xB341
SAMSON	0x0010
Vendor ID	
Profile	0xF100
Manufacturer	0x0042
Device type	TROVIS 3797
PA Profile specification version	4.02

The device driver software (GSD/FDI package) can be downloaded from our website (► www.samsongroup.com > Downloads > Software & Drivers > Device integration > 3797).

i Note

SAMSON supports various third-party operating tools (e.g. ABB, Siemens). SAMSON's TROVIS-VIEW software can also be used. The software can be downloaded free of charge from our website (► www.samsongroup.com > Downloads > Software & Drivers > TROVIS-VIEW).

6.5 First start-up

- ➔ Use a suitable start-up tool to assign a device name and IP address to the positioner. The corresponding tool of the process control system or a tool, such as Siemens PRONETA (see Chapter 6.5.1) or SAMSON's TROVIS-VIEW software, can be used as the start-up tool.
- ➔ Integrate the positioner with its device name and IP address into the process control system.
- ➔ Use the profile or provided GSD file to select a module. The following Actuator Function Block modules are available:
 - SP_SETPOINT
 - SETPOINT + CHECK_BACK
 - SETPOINT + READBACK + POS_D
 - SETPOINT + READBACK + POS_D + CHECK_BACK

Operation

- Initialize the positioner using an integration tool or by pressing the initialization button (see Chapter 6.2).

Note

The FDI package must be installed to be able to configure the positioner with an integration tool, such as ABB FIM or Siemens PDM.

After initialization is completed, the positioner is ready for use. The first set point can be entered over the 'Set point' parameter and 'Good - OK' assigned as the set point status.

6.5.1 Start-up using Siemens PRONETA

- Select the network adapter to match the required IP range.



- Select the 'Network analysis' option to find the positioner based on its MAC address.

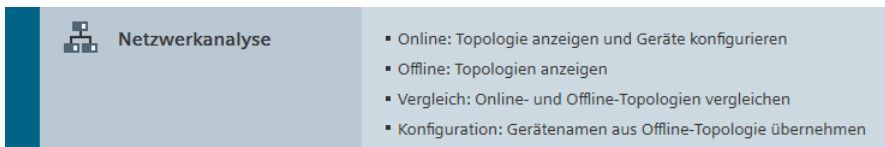

- Start scan.

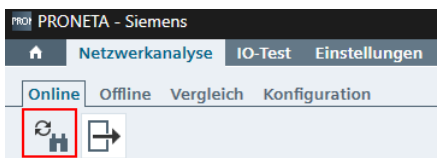

After the scan is completed, all devices in the network are shown.

- Right-click the positioner and select 'Set Network Parameters'.

**Tip**

The MAC address column can be sorted to find the MAC address of the positioner quicker (SAMSON devices always start with 00:e0:99).



→ Enter the device name and IP address.

The screenshot shows the 'Netzwerkparameter setzen' configuration window. It contains the following fields and options:

- Gerätename: trovis3797
- IP-Konfiguration:
 - Statische IP-Konfiguration
 - IP-Adresse: 172. 47. 11. 81
 - Subnetzmaske: 255. 255. 255. 0
 - Router als Gateway verwenden: 172. 29. 189. 53

The positioner is ready for use and can be integrated into the process control system.

6.6 Diagnostics

6.6.1 Profile diagnostic messages

The profile diagnostic messages provide detailed information on the positioner (coded bit-wise). They allow diagnosis flags, which are specified in NAMUR Recommendation NE 107, and general device diagnostics to be set. The device model-specific diagnostics are assigned to the corresponding Transducer Block (module/submodule), which mainly characterizes the device model.

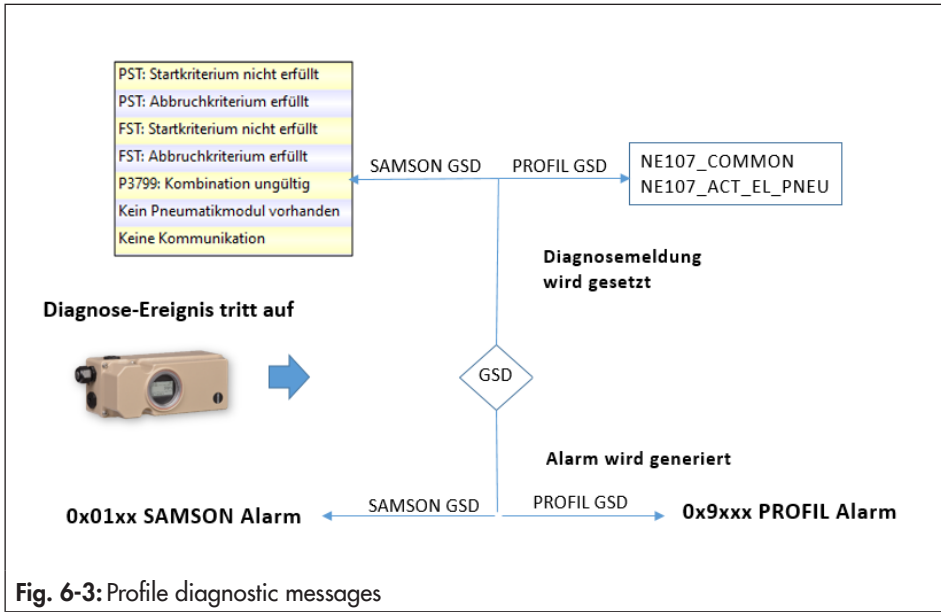

Fig. 6-3: Profile diagnostic messages

If a diagnostic event occurs in the positioner, a diagnostic alarm is generated depending on the GSD file used:

- When the GSD profile is used, only a generic diagnostic message (NE107_COMMON and NE107_ACT_EL_PNEU) and a corresponding diagnostic alarm are generated.
- When SAMSON's manufacturer-specific GSD file is used, a detailed diagnostic message and a corresponding diagnostic alarm are generated.



Table 6-4: NE107_COMMON alarms

Octet	Bit	Profinet Channel Error Number	Message
1	3	0x9003	Sensor element error
1	4	0x9004	Actuator element error
1	6	0x9006	Parameter setting error
1	1	0x9001	Evaluation electronics error
3	3	0x9013	Impermissible ambient temperature
3	6	0x9016	Auxiliary medium missing
4	4	0x901C	Communication failed



Table 6-5: NE107_ACT_EL_PNEU alarms

Octet	Bit	Profinet Channel Error Number	Message
1	2	0x925A	Supply pressure out of specification
2	4	0x9278	Changed friction
3	3	0x926B	Positioner temperature out of specification
3	5	0x926D	Error in the pneumatic unit
5	2	0x927A	Offset
5	3	0x927B	Impermissible dynamic load
5	4	0x927C	Mounting error
6	5	0x9285	Status message on operating mode
6	6	0x9286	Valve position histogram
6	7	0x9287	Zero and end position shift
7	1	0x9289	Analysis of internal signals
7	4	0x928C	Travel counter, total valve travel
7	5	0x928D	Step response diagnosis
3	6	0x926E	Incorrect travel measurement

6.6.2 Assignment of NAMUR status to READBACK STATUS

	Classification: NAMUR status	Description	Value	READBACK status
F 	Failure	An operational error exists.	0x24...0x27	BAD – maintenance alarm
C 	Function check	The device performs test and calibration procedures.	0x3C...0x3F	Good – function check / local override
S 	Out of specification	The device is being operated outside its technical specification (e.g. during start-up or cleaning).	0x78...0x7B	UNCERTAIN – process related, no maintenance

Operation

M 	Maintenance required	Maintenance is required.	0xA4...0xAB	UNCERTAIN – maintenance demanded
	No message	No message exists		GOOD



PB.NE107_STATUS



AO_TRD.FEEDBACK.STATUS



AO.READBACK.STATUS
AO.POS_D.STATUS

6.6.3 Alarms



Alarms are really helpful for the 0.1 % of communication needs that cannot be handled in the predefined cyclic format. They are event-driven. As a result, a PROFINET device will only send them if an event happens that the PROFINET controller needs to know about.

Alarms are activated by the positioner when a fault occurs. They are automatically deactivated again when the causes of the fault are remedied. A diagnostic message only triggers an alarm over PROFINET when its NAMUR status is not 'Good'.

An alarm communicated over PROFINET must contain the following information:

- Severity
- ChannelErrorType
- Qualifier

Table 6-6: *Readback status PROFINET mapping (severity and qualifier) · Severity and qualifier depend on the classification of the diagnostic message*

NAMUR status	PROFINET Severity	PROFINET Qualifier
Failure 	Fault	Qualifier_30
Function check 	Maintenance Demanded	Qualifier_24
Maintenance required 	Maintenance Demanded	Qualifier_22
Out of specification 	Advice	Qualifier_5





Meaning	READBACK STATUS	NAMUR status	PROFINET Severity	PROFINET Qualifier
AOFB mode is out of service	BAD - passivated	–	–	–
NAMUR status -> Failure	BAD - maintenance alarm	F 	Fault	Qualifier_30
NAMUR status -> Function check	BAD – function check / local override	C 	Maintenance Demanded	Qualifier_24
Fail-safe position set by the process control system	UNCERTAIN - initial value	–	–	–
NAMUR status -> Out of specification	UNCERTAIN - process related, no maintenance	S 	Advice	Qualifier_5
NAMUR status -> Maintenance required	UNCERTAIN – maintenance demanded	M 	Maintenance Demanded	Qualifier_22
NAMUR status -> No messages	GOOD - ok	–	–	–
Local operation enabled	GOOD - local override	–	–	–
Used to start a PST.	GOOD - function check	–	–	–

Table 6-7: Severity

Severity	Meaning
Fault	Immediate action. The channel no longer functions.
Maintenance demanded	Maintenance needs to be performed as soon as possible
Maintenance required	Maintenance needs to be performed soon
Advice	Normal operation. However, the process informs the user.
Good	Normal operation. This is shown when one of the above is not shown.

Operation

Table 6-8: *Process Value Status*

Process Value Status and substatus	Meaning
BAD - non specific	This is set by 'Fail Safe' under the condition that FSAFE_TYPE = fail-safe position and indicates that the device fail to communicate.
BAD - not connected	Communication failure
BAD - passivated	The current AOFB mode is out of service
BAD - maintenance alarm	NAMUR status -> Failure
BAD – function check / local override	NAMUR status -> Function check
Initial Fail Safe or communication failure	Fail-safe position active or communication failure
UNCERTAIN - initial value	First valid set point does not exist yet or no valid measured data exist during start-up
UNCERTAIN – maintenance demanded	NAMUR status -> Maintenance required
UNCERTAIN - process related, no maintenance	NAMUR status -> Out of specification
GOOD - ok	NAMUR status -> No messages
GOOD - initiate fail safe	Fail-safe position set by the process control system
GOOD - function check	This status is used to start a PST over the process control system.
GOOD - local override	Local operation enabled

These states only apply to parameters transmitted over cyclic communication. The process control system writes the status.

SP

BAD – XXX (status equal to BAD, independent of substatus)

UNCERTAIN – Initial Value

GOOD – initiate fail safe

GOOD – function check

These states apply to internal process parameters which are passed on to the valve for use by the valve.

OUT and POSITIONING_VALUE

BAD – non specific

BAD – passivated

UNCERTAIN – substitute set

GOOD – ok

GOOD – local override

READBACK and POS_D

BAD – passivated

BAD – maintenance alarm

BAD – function check / local override

UNCERTAIN – initial value

UNCERTAIN – process related, no maintenance

UNCERTAIN – maintenance demanded

GOOD – ok

GOOD – local override

GOOD – function check

FEEDBACK_VALUE and SIMULATE_STATUS

BAD – maintenance alarm

UNCERTAIN – process related, no maintenance

UNCERTAIN – maintenance demanded

BAD – function check / local override

GOOD – ok

GOOD – local override¹⁾

GOOD – function check

¹⁾ 'GOOD – local override' does not apply to the SIMULATE_STATUS parameter.

6.7 Write protection

The write protection function is used to control the access to parameters to change or activate them. The following write protection options are available depending on the method of communication:

- On-site operation locked (see ID 48313 for special rules)
- Bus communication locked (see ID 134920 for special rules)

Depending on the selected write protection option, observe the conditions for changing parameters (see Chapters 6.7.1 to 6.7.3).

6.7.1 Write protection for bus communication

The 'Write protection' parameter is used to protect write access to parameters over bus communication. As a result, this parameter can only be written over on-site operation (8.40.5) or TROVIS-VIEW (over serial interface).

There are three different types of write protection:

- Hardware write protection
All parameters that are accessed over cyclic communication are not affected by this write protection option.
- Hardware write protection with exceptions
All parameters that are accessed over cyclic communication are not affected by this write protection option except for the following parameters:
 - Target Mode (AOFB)
 - Target operating mode
 - OUT
 - The set point can be entered in the MAN mode.
 - The set point can be entered in the automatic mode (open-loop control).
- Password write protection
This setting is identical to the 'Hardware write protection' option, except that this write protection option can only be deactivated after entering the correct password (see Chapter 6.7.3, 'Password configuration' parameter)

6.7.2 Write protection for on-site operation

The 'Activate password' parameter allows the on-site operation to be protected by a four-figure PIN.

Enabling on-site operation in 'User level' [6] is locked by an active on-site write protection and can only be unlocked by entering the PIN. Once the correct PIN is entered over the on-site operation, operation is enabled for 10 minutes. After ten minutes, the on-site operation is automatically locked again. The PIN entry is locked for ten minutes after an incorrect PIN has been entered three times.

If bus communication fails longer than 30 seconds, the on-site operation is automatically enabled.

6.7.3 Password configuration

This parameter can be used to change the password.

The new password is immediately valid. Users must have their own individual password.

The default password is '1234'.

7 Start-up and configuration

The work described in this chapter is to be performed only by personnel appropriately qualified to carry out such tasks.

⚠ WARNING

Crush hazard arising from actuator and plug stem moving.

- Do not insert hands or finger into the yoke while the air supply is connected to the positioner.
- Do not impede the movement of the actuator and plug stem by inserting objects into the yoke.

Before start-up, make sure the following conditions are met:

- The positioner is properly mounted according to the instructions.
- The pneumatic and electrical connections are performed according to the instructions.

After the positioner is put into operation for the first time after shipment, the wizard starts automatically after the electrical power is connected. It assists users to set the display's reading direction and the menu language (English upon first start-up). The reading direction of the display depends on the mounting position (position of the pneumatic modules, right or left of the display).

1. Turn **⊗**: determine the reading direction of the display (mounting position with pneumatic modules on the right or left of the display).

2. Press **⊗** twice: Confirm reading direction.

3. Turn **⊗**: Select language.

4. Press **⊗** three times: Confirm language.

→ Afterwards, the display automatically changes to the main display.

→ When **ESC** is selected in the wizard, you can navigate through the displays of the wizard 1/3 (mounting position), 2/3 (language) and 3/3 (exit wizard) by selecting forward (**>**) and back (**<**).

→ If no settings are entered within five minutes, the positioner automatically returns to the main display.

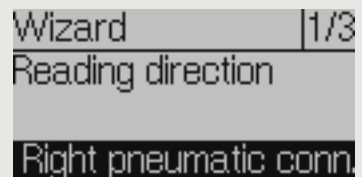







Start-up and configuration

Sequence for start-up:

Action	Chapter
1. Enable configuration.	7.1
2. Set start-up parameters: Actuator type, pin position, initialization mode, fail-safe position, pneumatic primary output, software restriction	7.2
3. Initialize the positioner.	7.3
4. Configuring option modules	7.4

7.1 Enabling configuration



The  icon indicates that configuration has not yet been enabled.

1. Press  (in start screen) to go to the main menu.
 2. Turn  until 'User level [6]' appears.
 3. Press and turn  until 'On-site: write' appears.
 4. Press  to confirm.
 5. Keep  pressed down for two seconds to return to the start screen.
- Configuration is enabled when the  icon is no longer visible on the display.

Configuration is locked again if no settings are entered within 5 minutes.

7.2 Setting start-up parameters



The start-up parameters listed in this chapter are set in the 'Start-up' menu. To access the 'Start-up' menu, proceed as follows:

1. Enable configuration as described in Chapter 7.1.
2. Press  (in start screen) to go to the main menu.
3. Turn  until 'Start-up [7]' appears.
4. Press  to go to the 'Start-up' menu.

7.2.1 Actuator type



Three different parameters are available for selection:

- Linear actuator
- Rotary actuator
- Linear actuator (expert) with separate setting options for pin position and nominal range

1. Turn  (within 'Start-up [7]' menu) until 'Actuator [7.1]' appears.
2. Press and turn  to set the actuator type.
3. Press  to confirm the setting.

7.2.2 Operation with small actuators

The 'Small actuator volume' setting must be selected beforehand for operation with small actuators. The setting is performed at the positioner by selecting the [7.2] menu item or over the integration. A special initialization routine is run when the setting for small actuators is selected. It adapts the positioner to the smaller actuator volume.

1. Turn  (within 'Start-up [7]' menu) until 'Small actuator volume (≤ 0.36) [7.2]' appears.
2. Press and turn  to set 'Yes'.
3. Press  to confirm the setting.

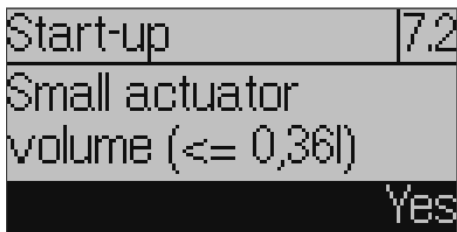

Start-up and configuration

Configuration in TROVIS-VIEW

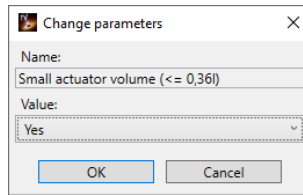
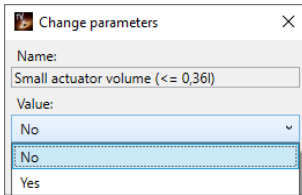

Name		Value	Unit	Code	Comment
Start-up					
Actuator	⊟	Linear actuator		7.1	
Small actuator volume (<= 0,36l)	⊟	No		7.2	
Pin position	⊟	35 mm		7.5	
Nominal range	⊟	10,0	mm	7.10	
Max. nom. range	⊟	10,0	mm	7.16	
Failure position	⊟	Close		7.20	ACTUATOR_ACTION
Initialization mode	⊟	NOM		7.24	
Mounted device	⊟	No device		7.50	
Output P3799 (primary)	⊟	OUTPUT 138		7.53	
Pressure limit	⊟	7,0	bar	7.58	
Automatic software restriction setting	⊟	Not active		7.62	
Software restriction (supply)	⊟	100 %		7.64	
Software restriction (exhaust)	⊟	100 %		7.65	
Init. with valve signature	⊟	Yes		7.68	



7.2.3 Pin position

The setting options depend on the entered actuator type:

- For linear actuator: 'Pin position [7.2]: 'None', 17, 25, 35, 50, 70, 100, 200 or 300 mm
- For rotary actuator: 'Pin position [7.3]': 90° and 'No lever'
- For linear actuator (expert): 'Pin position [7.4]: 10 to 655 mm



1. Turn  (within 'Start-up [7]' menu) until 'Pin position [7.2/7.3/7.4]' appears.
2. Press and turn  to enter the pin position to match how the actuator is mounted.
3. Press  to confirm the setting.

i Note

A pin position needs to be entered for the **NOM** and **SUB** initialization modes (see Chapter 7.2.5).

7.2.4 Nominal range

The possible adjustment range depends on the entered pin position.

1. Turn  (within 'Start-up [7]' menu) until 'Nominal range [7.10/7.11/7.12]' appears.
2. Press and turn  to set the nominal range.
3. Press  to confirm the setting.

i Note

If no pin position has been entered, 'Nominal range' is only available for the 'Linear actuator (expert)' actuator type.

7.2.5 Initialization mode

During initialization, the positioner adapts itself optimally to the friction conditions and the signal pressure required by the control valve. The type and extent of autotuning depends on the initialization mode selected. The following initialization modes are available:

MAX: Maximum range

The positioner determines travel/angle of rotation of the closing member from the closed position to the opposite travel stop and adopts this travel/angle of rotation as the operating range from 0 to 100 %.

NOM: Nominal range · Initialization mode for all globe valves

The calibrated sensor allows the exact valve travel to be measured very accurately. During initialization, the positioner checks whether the control valve can move through the indicated nominal range (travel or angle) without collision. If this is the case, the indicated nominal range is adopted as the operating range.

MAN: Manually selected end positions · Initialization mode for globe valves

Before starting initialization, move the control valve manually to the end positions. The positioner calculates the travel/angle difference from the two positions that the valve moved to and adopts it as the operating range. This initialization mode can only be started when the valve position differs in the end positions and the positioner has not yet been initialized.



SUB: Substitute calibration · To replace a positioner while the plant is running

A complete initialization procedure takes several minutes and requires the valve to move through its entire travel range several times. In the SUB initialization mode, the control parameters are estimated and not determined by an initialization procedure. As a result, a high level of accuracy cannot be expected. A different initialization mode should be selected if the plant allows it.

The substitute calibration is used to replace a positioner while the process is running. For this purpose, the control valve is usually blocked mechanically in a certain position or pneumatically by means of a pressure signal which is routed to the actuator externally. The blocking position ensures that the plant continues to operate with this valve position. The blocking position can also be the fail-safe position when this condition is beneficial for the temporary phase.

Perform a reset before re-initializing the positioner if the substitute positioner has already been initialized (see the 'Operation' chapter).

Setting the MAX and NOM initialization modes:

1. Turn  (within 'Start-up [7]' menu) until 'Initialization mode [7.24]' appears.
2. Press and turn  to set the **MAX** or **NOM** initialization mode.
3. Press  to confirm the setting.













i Note

*A pin position needs to be entered for the **NOM** initialization mode.*

Setting the **MAN** initialization mode

i Note

The **MAN** initialization mode can only be started when the valve position differs in the end positions and the positioner has not yet been initialized.













1. Turn  (within 'Start-up [7]' menu) until 'Initialization mode [7.24]' appears.
2. Press and turn  to set the **MAN** initialization mode.
3. Press  to confirm the setting.
4. Turn  until 'Set point (open-loop control) [7.28]' appears.
5. Press and turn  to move the valve to the first end position. Enter a value from -90 to 90° .
6. Press  to confirm the value (first end position).
7. Turn  until 'Adopt valve position 1 [7.29]' appears.
8. Press  to confirm the entered first valve position as valve position 1.
9. Turn  until 'Set point (open-loop control) [7.28]' appears.
10. Press and turn  to move the valve to the second end position. Enter a value from -90 to 90° .
11. Press  to confirm the value (second end position).
12. Turn  until 'Adopt valve position 2 [7.31]' appears.
13. Press  to confirm the entered second valve position as valve position 2.

Setting the **SUB** initialization mode:

i Note

The **SUB** initialization mode is a substitute calibration, which can be selected to replace a positioner while the process is running. In this mode, the control parameters are estimated and not determined by an initialization procedure. As a result, a high level of accuracy cannot be expected. A different initialization mode should be selected if the plant allows it. The **SUB** initialization mode can only be started when the positioner has not yet been initialized.

Start-up and configuration

1. Write down the current valve position in %.
2. Turn  (within 'Start-up [7]' menu) until 'Initialization mode [7.24]' appears.
3. Press and turn  to set the **SUB** initialization mode.
4. Press  to confirm the setting.
5. Turn  until 'Pin position [7.2/7.3/7.4]' appears.
6. Press and turn  to enter the pin position to match how the actuator is mounted.
7. Press  to confirm the setting.
8. Turn  until 'Nominal range [7.10/7.11/7.12]' appears.
9. Press and turn  to set the actuator's nominal range.
10. Press  to confirm the setting.
11. Turn  until 'Current valve position [7.35]' appears.
12. Press and turn  to set the current valve position in % (see step 1), at which the valve is currently blocked.
13. Turn  until 'Direction of rotation [7.36]' appears.
14. Press and turn  to set the direction of rotation so that the lever's direction of rotation matches the valve's closing direction.

Example:

The valve closes when the plug stem moves downward. This action causes the positioner's lever to turn counterclockwise (when looking at the display, the pneumatic module on the right).

→ Setting: Counterclockwise



Note

After performing the SUB initialization, the control parameters can be changed ('Configuration [8]'/ 'Control parameters [8.4]', see Appendix A).

7.2.6 Fail-safe action

Define the fail-safe position of the valve taking the valve type and the actuator's direction of action into account:



Fail-safe position	Description
AIR TO OPEN (closing)	Signal pressure opens the valve, e.g. for a fail-close valve The AIR TO OPEN setting always applies to double-acting actuators.
AIR TO CLOSE (opening)	Signal pressure closes the valve, e.g. for a fail-open valve

1. Turn  (within 'Start-up [7]' menu) until 'Fail-safe position [7.20]' appears.
2. Press  and turn it to set the fail-safe position AIR TO OPEN or AIR TO CLOSE.
3. Press  to confirm the setting.

For checking purposes: after initialization is completed, the positioner display must read 0 % when the valve is closed.

7.2.7 Pneumatic primary output

Which pneumatic signal on which the diagnostics or valve signature is to be based upon must be defined. OUTPUT 138 is set by default.

1. Turn  (within 'Start-up [7]' menu) until 'Output P3799 (primary) [7.53]' appears.
2. Press and turn  to assign 'OUTPUT 138' or 'OUTPUT 238'.
3. Press  to confirm the setting.

7.2.8 Software restriction

Note

The positioner must be re-initialized if the software restriction settings are changed after initialization.

Tip

We recommend setting the software restriction for supply and exhaust to a value of 50 % for actuators with diaphragm areas $\leq 240 \text{ cm}^2$.

Start-up and configuration









Positioner with pneumatic module combination P3799-0001, P3799-0002, P3799-0003 and P3799-0004

If the pneumatic module combinations P3799-0003 and P3799-0004 are installed in the positioner, the software restriction automatically adapts the air capacity to the actuator size during initialization.

i Note







The automatic software restriction setting must be deactivated when a pneumatic volume booster is mounted on the control valve.

If you want to set the software restriction manually, proceed as follows:

1. Turn  (within 'Start-up [7]' menu) until 'Automatic software restriction setting [7.62]' appears.
2. Press and turn  to set 'Not active'.
3. Press  to confirm the setting.
4. Turn  until 'Software restriction (supply) [7.64]' appears.
5. Press and turn  to set the value (25 to 100 %).
6. Press  to confirm the setting.
7. Turn  until 'Software restriction (exhaust) [7.65]' appears.
8. Press and turn  to set the value (25 to 100 %).
9. Press  to confirm the setting.

Positioner with two pneumatic modules P3799-0001







If the pneumatic module combination P3799-0001 and P3799-0001 is installed in the positioner, no automatic adaptation by the software restriction takes place. The control response to small step changes can be corrected by manually adjusting the software restriction after initialization. To do this, proceed as follows:

1. Turn  (within 'Configuration [8]' menu) until 'Software restriction (supply) [8.7.30]' appears.
2. Press and turn  to set the value (25 to 100 %).
3. Press  to confirm the setting.
4. Turn  until 'Software restriction (exhaust) [8.7.32]' appears.
5. Press and turn  to set the value (25 to 100 %).
6. Press  to confirm the setting.

If the air output capacity is generally too large for the actuator, remove the pneumatic module P3799-0001 at slot B and replace it with pneumatic module P3799-0000 (dummy module).

Positioner with pneumatic module combination P3799-0002 and P3799-0003

If the pneumatic module combination P3799-0002 and P3799-0003 is installed in the positioner, no automatic adaptation by the software restriction takes place. The control response to small step changes can be corrected by manually adjusting the software restriction after initialization. To do this, proceed as follows:

1. Turn  (within 'Configuration [8]' menu) until 'Software restriction (supply) [8.7.30]' appears.
2. Press and turn  to set the value (25 to 100 %).
3. Press  to confirm the setting.
4. Turn  until 'Software restriction (exhaust) [8.7.32]' appears.
5. Press and turn  to set the value (25 to 100 %).
6. Press  to confirm the setting.

If the air output capacity is generally too large for the actuator, change the hook-up. In case, after changing the hook-up, there are no longer any valve accessories (e.g. volume booster, quick exhaust valve) installed, change the pneumatic module combination to two P3799-0001 modules.

7.3 Initializing the positioner

Once all settings have been made according to Chapter 7.2, the positioner initialization can be started.

! NOTICE

The process is disturbed by the movement of the actuator or valve.

→ Do not perform the initialization while the process is running. First isolate the plant by closing the shut-off valves.



i Note

The initialization can only be started over the menu after configuration has been enabled.



When the positioner is fitted with pressure sensors, a valve signature can be recorded automatically after initialization is completed. In this case, the signal pressure is recorded together with the valve position and saved in the positioner as a reference value.

More details on the valve signature can be found in the Operating Instructions ► EB 8389-4.



The function is activated by default. To change the 'Initialization with valve signature' setting, proceed as follows:



1. Turn  (within 'Start-up [7]' menu) until 'Init. with valve signature [7.68]' appears.
2. Press and turn  to select the 'Yes' or 'No'.
3. Press  to confirm the setting.

Start initialization:

1. Turn  (within 'Start-up [7]' menu) until 'Start initialization [7.75]' appears.
2. Press  to start initialization.
3. Confirm warning with OK.
4. Wait until the initialization process is completed.

After initialization, the positioner remains in the 'Start initialization [7.75]' menu item.

- Keep  pressed down for two seconds to return to the main menu.
- Keep  pressed down again for two seconds to return to the start screen.

The valve position appears in % on the display. The positioner is in the automatic mode ( icon), the NAMUR status is OK () and configuration is still enabled.

→ **The positioner is ready for use.**



Initialization can also be started by pressing the initialization key (INIT).

7.4 Configuring option modules

→ Set parameters of option modules:

- [8.10.22] to [8.10.24] for slot C, see Appendix A (configuration instructions)
- [8.10.32] to [8.10.34] for slot D, see Appendix A (configuration instructions)

8 Operation

The work described in this chapter is to be performed only by personnel appropriately qualified to carry out such tasks.

DANGER

Risk of fatal injury due to the ignition of an explosive atmosphere.

- Observe EN 60079-14 (VDE 0165, Part 1) for work on the positioner in potentially explosive atmospheres.
- Work in potentially explosive atmospheres is to be performed only by personnel who has undergone special training or instructions or who is authorized to work on explosion-protected devices in hazardous areas.

WARNING





Crush hazard arising from actuator and plug stem moving.

- Do not insert hands or finger into the yoke while the air supply is connected to the positioner.
- Before working on the positioner, disconnect and lock the pneumatic air supply.
- Do not impede the movement of the actuator and plug stem by inserting objects into the yoke.

The positioner can be operated after mounting and start-up have been completed. After initialization, the positioner switches to closed-loop operation (automatic mode).



8.1 Changing operating mode

The following operating modes can be set at the positioner:

- **Automatic mode:** the positioner is in closed-loop operation and follows the control signal (indicated by the  icon). If the communication for open-loop control is active, the icon changes to .
- **Fail-safe position:** the pneumatic outputs of the positioner are either vented (exhaust) or supplied with air (supply) depending on the combination of the pneumatic modules (indicated by the  icon).
- **Manual mode:** the positioner follows the 'Manual set point [MAN 3]' instead of the control signal. Manual mode is indicated by the  icon.

Operation

Setting the target operating mode:

1. Turn  (in start screen) until 'Target operating mode [1]' appears.
2. Press and turn  to select the target operating mode.
3. Press  to confirm the setting.

8.2 Performing zero calibration

In case of inconsistencies in the closed position of the valve, e.g. with soft-seated plugs, it might be necessary to recalibrate zero. During zero calibration, the valve moves once to the closed position.



NOTICE

The process is disturbed by the movement of the actuator or valve.

→ Do not perform the zero calibration while the process is running. First isolate the plant by closing the shut-off valves.

Note

A zero calibration is not possible if there is zero point shift of more than 5 %.

1. Turn  (within 'Start-up [7]' menu) until 'Start zero calibration [7.76]' appears.
2. Press  to start zero calibration.
3. Confirm warning with OK.
4. Wait until zero calibration is completed.

After zero calibration, the positioner remains in the 'Start zero calibration [7.76]' menu item.





→ Keep  pressed down for two seconds to return to the main menu.

→ Keep  pressed down again for two seconds to return to the start screen.

8.3 Resetting the positioner

A reset allows the positioner to be reset to the default settings. The TROVIS 3797 Positioner has the following reset options:

Reset function	Description	Sample application
Reset diagnosis	Resets all diagnostic functions including graphs and histograms.	Diagnosis analyses of operating hours in the past are no longer relevant.
Reset (standard)	Resets the positioner to the state as upon delivery. Actuator and valve-specific settings remain unchanged.	Positioner has been repaired or modified. The diagnosis data are no longer relevant. The positioner must be re-initialized.
Reset (advanced)	All parameters will be reset to their defaults adjusted upon delivery.	Positioner is mounted on another actuator/valve.
Restart	The positioner is shut down and restarted.	Putting the device back into operation after failure
Reset initialization	All parameters for the start-up settings (see the 'Start-up and configuration' chapter) are reset. The positioner needs to be re-initialized afterwards.	Changes to the start-up settings are necessary.
Reset reports	Reset all reports and graphs/diagrams generated by the partial stroke (PST) and full stroke (FST) tests.	The existing test results and assessments are no longer relevant.
Reset communication	Reset network configuration (IPv4 address, IPv4 mask and device name)	The positioner is removed from the control valve and there are no plans to remount it on the same valve.
Reset application	Resets the positioner to the state as upon delivery. Actuator and valve-specific settings remain unchanged.	

1. Turn  (within main menu) until 'Reset functions [14]' appears.
2. Press  to go to the menu.
3. Turn  to select a reset function.
4. Press  to perform the reset function.
5. Confirm warning with OK.
6. Wait until the reset function is completed.

9 Malfunction

⚠ DANGER

Risk of fatal injury due to the ignition of an explosive atmosphere.

- Observe EN 60079-14 (VDE 0165, Part 1) for work on the positioner in potentially explosive atmospheres.
- Work in potentially explosive atmospheres is to be performed only by personnel who has undergone special training or instructions or who is authorized to work on explosion-protected devices in hazardous areas.

⚠ DANGER

Risk of bursting in the pneumatic actuator due to the use of a fail-in-place module.

Before working on the positioner, actuator or any other valve accessories:

- Depressurize all plant sections concerned and the actuator. Release any stored energy.

⚠ WARNING

Crush hazard arising from actuator and plug stem moving.

- Do not insert hands or finger into the yoke while the air supply is connected to the positioner.
- Before working on the positioner, disconnect and lock the pneumatic air supply.

- Do not impede the movement of the actuator and plug stem by inserting objects into the yoke.





Malfunctions and errors are indicated on the display by error messages in conjunction with an icon for status classification (see Table 9-1) and an error ID. Table 9-2 lists possible error messages and recommended action.

i Note

- Contact SAMSON's After-sales Service for malfunctions not listed in the table.
- The status classification of error messages can be changed in SAMSON's TROVIS-VIEW software.







Malfunction

Table 9-1: Status classification

Icon	Meaning
	Failure
	Function check
	Out of specification
	Maintenance demanded













9.1 Troubleshooting

Table 9-2: Troubleshooting

Error ID	Status	Message	Recommended action
1		Init: rated travel not achieved	→ Check attachment and pin position.
2		Init: travel too small	→ Check start-up settings. → Check attachment.
3		Init: no movement	→ Check positioner mounting, pin position and supply air. Check piping and configuration of the mounting parts. Move the positioner out of the fail-safe position.
21		Init: pin position	→ Check pin position.
26		Timeout for detection of zero	→ Check attachment. → Check supply pressure.
27		Positioner not initialized	→ Perform an initialization.
29		Init: incorrect operating mode	The positioner cannot perform the function that has been started because it is in the wrong mode. This message appears for example, when a test is started while the positioner is in the automatic mode (the manual mode is required to perform tests).

¹⁾ Highest classification

²⁾ The pneumatic module (A or B) affected is also indicated in addition to the error ID.

Error ID	Status	Message	Recommended action
31		Init: canceled externally	→ Check input signal.
36		Zero calibration shift >>	→ Check attachment. → Check supply pressure.
50		PST: start criteria not met	→ Check the configuration of the test parameter (see Operating Instructions ► EB 8389-4)
51		PST: cancellation criteria met	→ Check the configuration of the test parameter (see Operating Instructions ► EB 8389-4)
56		FST: start criteria not met	→ Check the configuration of the test parameter (see Operating Instructions ► EB 8389-4)
57		FST: cancellation criteria met	→ Check the configuration of the test parameter (see Operating Instructions ► EB 8389-4)
100		P3799: combination invalid	→ Check configuration. Install the correct pneumatic modules.
101		No pneumatic module	→ Install pneumatic module (at least one pneumatic module must be installed).
144		Temperature inside device below min. limit	→ Check the installation of the control valve concerning possible environmental and ambient influences. If necessary, protect the control valve better against environmental influences.
145		Max. limit temperature exceeded	
146		Test in progress	The positioner is in the test mode (e.g. initialization process, partial stroke test etc.). → Wait until the test is completed or cancel it.
150		Operating mode not AUTO	The positioner does not follow the control signal because it is not in automatic mode. The message no longer appears as soon as the positioner changes back to automatic mode.
155		Dynamic stress factor >>	→ Check the state of the valve packing.

¹⁾ Highest classification









²⁾ The pneumatic module (A or B) affected is also indicated in addition to the error ID.

Malfunction

Error ID	Status	Message	Recommended action
156		Limit for total valve travel exceeded	→ Check valve and attachment for signs of wear.
194		Set point deviation	→ Check attachment. → Check air supply. → Check air lines/connections.
195		Lower end position shifted	→ Check seat and plug.
196		Upper end position shifted	→ Check seat and plug.
206		Valve signature recording failed	→ Check configuration. → Restart valve signature. → Initialize positioner with setting 'Init. with valve signature' = Yes.
207		No supply pressure	→ Check air supply. → Check air lines/connections.
208		Low supply pressure	→ Check air supply. → Check supply pressure regulator. → Check air lines/connections.
209		Pressure sensors failed	→ Check the supply pressure. → Check input signal.
210		Supply pressure > 10 bar	→ Check air supply. → Check supply pressure regulator.
211		Emergency mode active	→ Check travel measurement.
212		Friction change (mid-pos.)	The friction conditions have changed. → Check the control valve's mechanical functions and setup.
213		Friction change (open pos.)	
214		Friction change (closed pos.)	
215		Logging suspended	The positioner's functioning is not impaired. The message no longer appears after the positioner starts logging again.

¹⁾ Highest classification



²⁾ The pneumatic module (A or B) affected is also indicated in addition to the error ID.

Error ID	Status	Message	Recommended action
222		Operating range in CLOSED position	<ul style="list-style-type: none"> ➔ Check attachment. ➔ Check supply pressure. ➔ Check whether another valve can be used.
223		Operating range in max. OPEN position	<ul style="list-style-type: none"> ➔ Check attachment. ➔ Check supply pressure. ➔ Check whether another valve can be used.
224		Operating range shifting towards CLOSED position	➔ Rethink the working range.
225		Operating range shifts towards max. OPEN position	➔ Rethink the working range.
226		Limited working range: lower range	<ul style="list-style-type: none"> ➔ Check that pneumatic installations and connections are tight. ➔ Check supply pressure. ➔ Check plug stem for external influences that could be blocking it.
227		Limited working range: upper range	<ul style="list-style-type: none"> ➔ Check that pneumatic installations and connections are tight. ➔ Check supply pressure. ➔ Check plug stem for external influences that could be blocking it.
232		Fail-in-place module	Fail-in-place module has been activated. No action possible. The error message is cleared as soon as the conditions that caused the status messages to be generated no longer prevail.
233		Fail-in-place module	➔ Contact SAMSON's After-sales Service.
2641	¹⁾	Init: canceled (control accuracy)	➔ Check attachment.
2643	¹⁾	Init: angle limitation	<ul style="list-style-type: none"> ➔ Check start-up settings. ➔ Check attachment.
2644	¹⁾	Init: low control accuracy	➔ Check attachment.
2645	¹⁾	Init: timeout	<ul style="list-style-type: none"> ➔ Check start-up settings. ➔ Check attachment. ➔ Check supply pressure.

¹⁾ Highest classification

²⁾ The pneumatic module (A or B) affected is also indicated in addition to the error ID.

Malfunction

Error ID	Status	Message	Recommended action
3331	1)	P3799: failure ²⁾	<ul style="list-style-type: none"> ➔ Check air quality. ➔ Contact SAMSON's After-sales Service.
3332	1)	P3799: movement impaired ²⁾	<ul style="list-style-type: none"> ➔ Check air supply. ➔ Contact SAMSON's After-sales Service.
3333	1)	P3799: maintenance required ²⁾	➔ Check air supply.
3329	1)	P3799: initialization error ²⁾	➔ Contact SAMSON's After-sales Service.
1369		AMR signal outside range	➔ Check attachment.
2653		Hardware fault	<ul style="list-style-type: none"> ➔ Confirm error and select AUTO operating mode. ➔ Re-initialize the positioner.
2642	1)	Angle limitation	➔ Check attachment.

1) Highest classification

2) The pneumatic module (A or B) affected is also indicated in addition to the error ID.

Table 9-3: *Further troubleshooting*

Error description	Action
No reading on the display	<ul style="list-style-type: none"> → Check electrical connection and power supply. → Check the ambient temperature (the display's operating range is from -30 to +65 °C).
Actuator moves too slowly	<ul style="list-style-type: none"> → Check the supply pressure. → Deactivate software restriction. → Correct setting for filter (transit time). → Install second pneumatic module. → Check the cross-section of the piping and screw fittings. → Check the configuration of the mounting parts.
Actuator moves in the wrong direction.	<ul style="list-style-type: none"> → Check the characteristic setting. → Check the setting for OUTPUT. → Check the piping. → Check the configuration of the mounting parts.
Strong leakage from the device.	<ul style="list-style-type: none"> → Check the installation of the pneumatic modules. → Check attachment. → Check the seals in the connecting plate.
Limit contact does not work properly	<ul style="list-style-type: none"> → Check the mounting and cabling. → Check polarity of signal wires.

9.2 Emergency action

Upon failure of the air supply, the positioner vents the actuator, causing the valve to move to the fail-safe position determined by the actuator. If a fail-in-place module is installed, it causes the pneumatic actuator to move to a position between the operating point and fail-safe position depending on the actuator size and the pressure range. As a result, emergency venting of the actuator is not guaranteed.

Upon failure of the electrical signal, the pneumatic outputs of the positioner are either vented or supplied with air. If a fail-in-place module is installed, it causes the pneumatic actuator to remain in its last position.

Plant operators are responsible for emergency action to be taken in the plant.



Tip

Emergency action in the event of valve failure is described in the associated valve documentation.

10 Servicing

The work described in this chapter is to be performed only by personnel appropriately qualified to carry out such tasks.

⚠ DANGER

Risk of fatal injury due to the ignition of an explosive atmosphere.

- Observe EN 60079-14 (VDE 0165, Part 1) for work on the positioner in potentially explosive atmospheres.
- Work in potentially explosive atmospheres is to be performed only by personnel who has undergone special training or instructions or who is authorized to work on explosion-protected devices in hazardous areas.

⚠ DANGER

Risk of bursting in the pneumatic actuator due to the use of a fail-in-place module.

Before working on the positioner, actuator or any other valve accessories:

- Depressurize all plant sections concerned and the actuator. Release any stored energy.

⚠ WARNING

Crush hazard arising from actuator and plug stem moving.

- Do not insert hands or finger into the yoke while the air supply is connected to the positioner.
- Before working on the positioner, disconnect and lock the pneumatic air supply.

- Do not impede the movement of the actuator and plug stem by inserting objects into the yoke.

The positioner was checked by SAMSON before it left the factory.

- The product warranty becomes void if service or repair work not described in these instructions is performed without prior agreement by SAMSON's After-sales Service.
- Only use original spare parts by SAMSON, which comply with the original specifications.

10.1 Cleaning the cover window

ⓘ NOTICE

Incorrect cleaning will damage the window.

The window is made of Makrolon® and will be damaged when cleaned with abrasive cleaning agents or agents containing solvents.

- Do not rub the window dry.
- Do not use any cleaning agents containing chlorine or alcohol or abrasive cleaning agents.
- Use a non-abrasive, soft cloth for cleaning.

10.2 Firmware updates

Contact your local SAMSON engineering and sales office or subsidiary (▶ www.samsongroup.com > *About SAMSON > Sales offices*) to request a firmware update.

Required specifications





Please submit the following details on requesting a firmware update:

- Type
- Serial number
- Material number
- Current firmware version
- Required firmware version

10.3 Periodic inspection and testing of the positioner

SAMSON recommends inspection and testing according to Table 10-1 at the minimum.

Table 10-1: *Recommended inspection and testing*

Inspection and testing	Action to be taken in the event of a negative result
Check the markings, labels and nameplates on the positioner for their readability and completeness.	Contact SAMSON when nameplates or labels are damaged, missing or incorrect to renew them.
	Clean any inscriptions that are covered with dirt and are illegible.
Check the positioner and leakage sensor (if installed) to ensure they are mounted firmly.	Tighten the any loose mounting screws.
Check the pneumatic connections.	Tighten any loose male connectors of the screw fittings.
	Renew any air pipes or hoses that leak.
Check the electric power wires.	Tighten any loose cable glands.
	Make sure that the stranded wires are pushed into the terminals and tighten any loose screws on the the terminals.
	Renew damaged wires.
Check error messages on the display (indicated by the  ,  ,  and  icons).	Troubleshooting (see the 'Malfunctions' chapter).

11 Decommissioning

The work described in this chapter is to be performed only by personnel appropriately qualified to carry out such tasks.

DANGER

Risk of fatal injury due to the ignition of an explosive atmosphere.

- *Observe EN 60079-14 (VDE 0165, Part 1) for work on the positioner in potentially explosive atmospheres.*
- *Work in potentially explosive atmospheres is to be performed only by personnel who has undergone special training or instructions or who is authorized to work on explosion-protected devices in hazardous areas.*

DANGER

Risk of bursting in the pneumatic actuator due to the use of a fail-in-place module.

Before working on the positioner, actuator or any other valve accessories:

- *Depressurize all plant sections concerned and the actuator. Release any stored energy.*

NOTICE

Interrupting closed-loop control will disturb the process.

- *Do not mount or service the positioner while the process is running and only after isolating the plant by closing the shut-off valves.*

To put the positioner out of operation, proceed as follows:

1. Disconnect and lock the air supply and signal pressure.
2. Open the positioner cover and disconnect the wires for the control signal.

12 Removal

The work described in this chapter is to be performed only by personnel appropriately qualified to carry out such tasks.

⚠ DANGER

Risk of fatal injury due to the ignition of an explosive atmosphere.

- *Observe EN 60079-14 (VDE 0165, Part 1) for work on the positioner in potentially explosive atmospheres.*
 - *Work in potentially explosive atmospheres is to be performed only by personnel who has undergone special training or instructions or who is authorized to work on explosion-protected devices in hazardous areas.*
-

1. Put the positioner out of operation (see the 'Decommissioning' chapter).
2. Disconnect the wires for the control signal from the positioner.
3. Disconnect the lines for supply air and signal pressure (not required for direct attachment using a connection block).
4. To remove the positioner, loosen the three fastening screws on the positioner.

13 Repairs

A defective positioner must be repaired or replaced.

! NOTICE

Risk of positioner damage due to incorrect service or repair work.

- *Do not perform any repair work on your own.*
 - *Contact SAMSON's After-sales Service for service and repair work.*
-

13.1 Returning devices to SAMSON

Defective positioners can be returned to SAMSON for repair.

Proceed as follows to return devices to SAMSON:

1. Put the positioner out of operation (see the 'Decommissioning' chapter).
2. Remove the positioner (see the 'Removal' chapter).
3. Proceed as described on the Returning goods page of our website
 - ▶ www.samsongroup.com > SERVICE > After-sales Service > Returning goods

14 Disposal



SAMSON is a producer registered in Europe, agency in charge

▶ <https://www.ewrn.org/national-registers/national-registers>.

WEEE reg. no.

DE 62194439/FR 025665

- Observe local, national and international refuse regulations.
- Do not dispose of components, lubricants and hazardous substances together with your other household waste.



On request, SAMSON can appoint a service provider to dismantle and recycle the product.

15 Certificates

The following certificates are included on the next pages:

- EU declaration of conformity for TROVIS 3797-110
- EU type examination certificate for TROVIS 3797
- IECEx certificate for TROVIS 3797
- CCC-Ex certificate for TROVIS 3797

The certificates shown were up to date at the time of publishing. The latest certificates can be found on our website:

► www.samsongroup.com > PRODUCTS > Valve accessories > TROVIS 3797

EU DECLARATION OF CONFORMITY TRANSLATION



This declaration of conformity is issued under the sole responsibility of the manufacturer.

Manufacturer:

SAMSON AKTIENGESELLSCHAFT
Weismüllerstraße 3
60314 Frankfurt am Main
Deutschland

Product designation:

TROVIS 3797-110 Smart Positioner (PROFINET®)
Hardware Version 2.00.xx

The product described above is in conformity with the relevant Union harmonisation legislation:

EU Directive	Standards / Technical Specifications
2014/30/EU	EN 61000-6-2:2005 EN 61000-6-3:2007/A1:2011 EN 61326-1:2013
2014/34/EU	EN 60079-0:2018 EN 60079-11:2012 IEC TS 60079-47: Edition 1.0
2011/65/EU	EN IEC 63000:2018

Additional information to EU directive 2014/34/EU (ATEX):

The notified body:

DEKRA Testing and Certification GmbH / Identification number 0158
Handwerkstraße 15
70565 Stuttgart
Deutschland

performed the EU Type Approval and issued the certificate BVS 21 ATEX E 080.

Signed for and on behalf of:

Frankfurt am Main, 2024-04-29

A handwritten signature in black ink, appearing to read "Fabio Roma".

Fabio Roma
Vice President Smart Products & Components

A handwritten signature in blue ink, appearing to read "i.v. J. Bieger".

Jens Bieger
Director Development Electronics



Translation

EU-Type Examination Certificate

Directive 2014/34/EU of the European Parliament and of the Council of 26 February 2014

EU-Type Examination Certificate Number: **BVS 21 ATEX E 080** Issue: **02**

Equipment: **Positioner type TROVIS 3797**

Manufacturer: **SAMSON AG**

Address: **Weismüllerstraße 3, 60314 Frankfurt am Main, Germany**

This product and any acceptable variations thereto are specified in the appendix to this certificate and the documents referred to therein.

DEKRA Testing and Certification GmbH, Notified Body number 0158, in accordance with Article 17 of Directive 2014/34/EU of the European Parliament and of the Council, dated 26 February 2014, certifies that this product has been found to comply with the Essential Health and Safety Requirements relating to the design and construction of products intended for use in potentially explosive atmospheres given in Annex II to the Directive.

The examination and test results are recorded in the confidential Report No. BVS PP 21.2142 EU. This issue of the EU-Type Examination Certificate replaces the previous issue of the EU-Type Examination Certificate BVS 21 ATEX E 080 issue 01.

Compliance with the Essential Health and Safety Requirements has been assured by compliance with:

EN IEC 60079-0:2018	General requirements
EN 60079-11:2012	Intrinsic Safety "i"
IEC TS 60079-47, Ed. 1.0	Equipment protection by 2-wire intrinsically safe Ethernet concept (2-WISE)

If the sign "X" is placed after the certificate number, it indicates that the product is subject to the "Specific Conditions of Use" listed under item 17 of this certificate.

This EU-Type Examination Certificate relates only to the technical design of the specified product in accordance with the Directive 2014/34/EU. Further requirements of the Directive apply to the manufacturing process and supply of this product. These are not covered by this certificate.

The marking of the product shall include the following:

 **II 2G Ex ia IIC T4/T6 Gb**

DEKRA Testing and Certification GmbH
Bochum, 2024-05-14

Signed: Oliver Brumm

Managing Director





IECEX Certificate of Conformity

INTERNATIONAL ELECTROTECHNICAL COMMISSION IEC Certification System for Explosive Atmospheres

for rules and details of the IECEX Scheme visit www.iecex.com

Certificate No.:	IECEX BVS 21.0083	Page 1 of 4	<u>Certificate history:</u> Issue 1 (2023-03-08) Issue 0 (2021-12-10)
Status:	Current	Issue No: 2	
Date of Issue:	2024-05-21		
Applicant:	SAMSON AG Weismüllerstraße 3 60314 Frankfurt am Main Germany		
Equipment:	Positioner type TROVIS 3797		
Optional accessory:			
Type of Protection:	Intrinsic Safety "I", 2-wire intrinsically safe Ethernet concept (2-WISE)		
Marking:	Ex ia IIC T4/T6 Gb		

Approved for issue on behalf of the IECEX
Certification Body:

Dr Franz Eickhoff

Position:

**Senior Lead Auditor, Certification Manager and officially
recognised expert**

Signature:
(for printed version)

Date:
(for printed version)

1. This certificate and schedule may only be reproduced in full.
2. This certificate is not transferable and remains the property of the issuing body.
3. The Status and authenticity of this certificate may be verified by visiting www.iecex.com or use of this QR Code.



Certificate issued by:

DEKRA Testing and Certification GmbH
Certification Body
Dinnendahlstrasse 9
44809 Bochum
Germany





IECEX Certificate of Conformity

Certificate No.: **IECEX BVS 21.0083**

Page 2 of 4

Date of issue: 2024-05-21

Issue No: 2

Manufacturer: **SAMSON AG**
Weismüllerstraße 3
60314 Frankfurt am Main
Germany

Manufacturing locations: **SAMSON AG**
Weismüllerstraße 3
60314 Frankfurt am Main
Germany

This certificate is issued as verification that a sample(s), representative of production, was assessed and tested and found to comply with the IEC Standard list below and that the manufacturer's quality system, relating to the Ex products covered by this certificate, was assessed and found to comply with the IECEx Quality system requirements. This certificate is granted subject to the conditions as set out in IECEx Scheme Rules, IECEx 02 and Operational Documents as amended

STANDARDS :

The equipment and any acceptable variations to it specified in the schedule of this certificate and the identified documents, was found to comply with the following standards

[IEC 60079-0:2017](#) Explosive atmospheres - Part 0: Equipment - General requirements
Edition:7.0

[IEC 60079-11:2011](#) Explosive atmospheres - Part 11: Equipment protection by intrinsic safety "i"
Edition:6.0

[IEC TS 60079-47:2021](#) Explosive atmospheres – Part 47: Equipment protection by 2-wire intrinsically safe Ethernet concept (2-WISE)
Edition:1.0

This Certificate **does not** indicate compliance with safety and performance requirements other than those expressly included in the Standards listed above.

TEST & ASSESSMENT REPORTS:

A sample(s) of the equipment listed has successfully met the examination and test requirements as recorded in:

Test Report:

[DE/BVS/ExTR21.0083/02](#)

Quality Assessment Report:

[DE/TUN/QAR06.0011/12](#)



IECEX Certificate of Conformity

Certificate No.: **IECEX BVS 21.0083**

Page 3 of 4

Date of issue: 2024-05-21

Issue No: 2

EQUIPMENT:

Equipment and systems covered by this Certificate are as follows:

General product information:

The positioner TROVIS 3797 is a 2-WISE power load suitable for use in a 2-WISE system. It is a single or double acting positioner for attachment to pneumatic control valves. It consists of a non-contact travel sensor system, an i/p-converter and the μ C supported electronics. The positioner ensures a predetermined assignment of the valve position to the setpoint. The valve position is transmitted either as an angle of rotation or a travel to the pick-up lever, from there to the travel sensor and forwarded it to the microcontroller. The PID algorithm in the microcontroller continuously compares the valve position measured by the position sensor with the setpoint from the control system. In case of a set point deviation, the pneumatic module causes the actuator to be either vented or filled with air. As a result, the closure member of the valve (e.g. plug) is moved to the position determined by the setpoint.

The data exchange and the electrical supply to the control units are carried out via Ethernet Advanced Physical Layer (APL).

Model type code:

See Annex

Ratings:

The Signal Circuit Terminal 11 (+) / 12 (-) is a **2-WISE power load** port with level of protection "Ia" and for use in hazardous areas with Group IIC gases.

Ambient temperature range:

T4: $-40\text{ }^{\circ}\text{C} \leq T_{\text{amb}} \leq +80\text{ }^{\circ}\text{C}$ or T6: $-40\text{ }^{\circ}\text{C} \leq T_{\text{amb}} \leq +55\text{ }^{\circ}\text{C}$

With Option Inductive Limit Switches

T4: $-40\text{ }^{\circ}\text{C} \leq T_{\text{amb}} \leq +70\text{ }^{\circ}\text{C}$ or T6: $-40\text{ }^{\circ}\text{C} \leq T_{\text{amb}} \leq +45\text{ }^{\circ}\text{C}$

SPECIFIC CONDITIONS OF USE: NO



IECEX Certificate of Conformity

Certificate No.: **IECEX BVS 21.0083**

Page 4 of 4

Date of issue: 2024-05-21

Issue No: 2

DETAILS OF CERTIFICATE CHANGES (for issues 1 and above)

- Change of the power limitation circuit
- Introduction of the temperature class T6

Annex:

[BVS_21_0083_Samson_Annex_issue2.pdf](#)



IECEX Certificate of Conformity



Certificate No.: **IECEX BVS 21.0083 issue No: 2**
Annex
Page 1 of 1

Model type code:

	b	c	d	e	f	g	h	i	j	k	l	m	n	o	p	q
3797-	x	x	x	x	x	x	x	x	x	x	x	x	x	x	x	x
	b c d			Explosion protection												
	0	0	0	Without												
	1	1	0	II 2G Ex ia IIC T4/T6 Gb (according to ATEX)												
	1	1	1	Ex ia IIC T4/T6 Gb (according to IECEx)												
	e			Function (not safety relevant)												
	f g			Pneumatics (not safety relevant)												
	h i			Option module 1												
	0	0	Without													
	j k			Option module 2												
	0	0	Without													
	1	5	with Inductive Limit Switches (NC) and Binary Output (Code P)													
	1	6	with Inductive Limit Switches (NO) and Binary Output (Code P)													
	l			Pressure sensor												
	2	Standard (Supply 9, Output 138, Output 238)														
	m			Electrical connections												
	1	1 cable gland, 3 blind plugs														
	n			Housing material												
	0	Aluminum die cast														
	1	Stainless steel (1.4408)														
	o			Special applications (not safety relevant)												
	p			Additional approvals (not safety relevant)												
	q			Ambient temperature f. Cable glands (not safety relevant)												
	0	-20 °C ... +80 °C (plastics cable glands)														
	1	-40 °C ... +80 °C (metallic cable glands)														
	2	-55 °C ... +80 °C (metallic cable glands)														



中国国家强制性产品认证证书

证书编号: 2024322307006083

认证委托人名称及地址

SAMSON AKTIENGESELLSCHAFT
Weismuellerstr. 3, 60314 Frankfurt am Main, Germany

生产者名称及地址

SAMSON AKTIENGESELLSCHAFT
Weismuellerstr. 3, 60314 Frankfurt am Main, Germany

生产企业名称及地址

SAMSON AKTIENGESELLSCHAFT
Weismuellerstr. 3, 60314 Frankfurt am Main, Germany

产品名称和系列、型号、规格

阀门定位器 TROVIS 3797
TROVIS 3797 系列

产品标准和技术要求

GB/T 3836.1-2021、GB/T 3836.4-2021

上述产品符合《强制性产品认证实施规则 防爆电气》
(CNCA-C23-01:2024)的要求, 特发此证。

发证日期:2024年07月15日 有效期至:2029年07月14日

首次发证日期:2024年07月15日

认证模式:型式试验+初始工厂检查+获证后监督

证书信息和有效性可扫描下方二维码或登录发证机构网站查验,
也可在认监委网站 (www.cnca.gov.cn) 查询。



批准:



上海仪器仪表自控系统检验测试所有限公司

<http://www.sitias.com.cn>

中国·上海·漕宝路103号200233

电话: +86 21 64518419



CERTIFICATE FOR CHINA COMPULSORY PRODUCT CERTIFICATION

CERTIFICATE NO.: 2024322307006083

NAME AND ADDRESS OF THE APPLICANT

SAMSON AKTIENGESELLSCHAFT

Weismuellerstr. 3, 60314 Frankfurt am Main, Germany

NAME AND ADDRESS OF THE MANUFACTURER

SAMSON AKTIENGESELLSCHAFT

Weismuellerstr. 3, 60314 Frankfurt am Main, Germany

NAME AND ADDRESS OF THE FACTORY

SAMSON AKTIENGESELLSCHAFT

Weismuellerstr. 3, 60314 Frankfurt am Main, Germany

NAME, SERIES, MODEL AND SPECIFICATION

Positioner TROVIS 3797

TROVIS 3797 series

THE STANDARDS AND TECHNICAL REQUIREMENTS FOR THE PRODUCTS

GB/T 3836.1-2021、GB/T 3836.4-2021

This is to certify that the above-mentioned product(s) complies with the requirements of implementation rules for compulsory certification (CNCA-C23-01:2024).

Issue date:2024-07-15 Valid until:2029-07-14

Date of initial issue:2024-07-15

Type of Certification: Type test + Initial inspection + Surveillance inspection

The certificate details and validity can be verified by scanning the QR code below or logging into the issuing authority's official website. It can also be inquired on the CNCA website (www.cnca.gov.cn).

(In case of dispute, the Chinese text shall prevail.)



APPROVAL:



Shanghai Inspection and Testing Institute of Instruments and Automation Systems Co., Ltd.

<http://www.sitiias.com.cn>

103 Cao Bao Road, Shanghai 200233,China

Tel: +86 21 64518419



中国国家强制性产品认证证书

证书编号: 2024322307006083

证书附页: 第1页共2页

产品名称:
阀门定位器 TROVIS 3797

型号规格:

Positioner Type TROVIS 3797
With LCD, autotune, PROFINET® communication

	a	b	c	d	e	f	g	h	i	j	k	l	m	n	o	p	q	r	s	t	u	v	w	x	y	z						
3	7	9	7	-	x	x	x	0	x	x	0	0	0	0	0	2	1	0	0	0	1	0	x	0	0	0	0	9	9	9	9	9
Explosion protection																																
1 1 2 CCC Ex / NEPSI Ex Ia IIC T4/T6 Gb																																
Function																																
Pneumatics																																
0 1 Single/double acting, k_{VS} 0.35																																
0 2 Single/double acting, k_{VS} 0.7																																
0 3 Single acting, 2x independent, k_{VS} 0.35																																
Option module 1																																
0 0 Without																																
Option module 2																																
0 0 Without																																
1 5 with Inductive Limit Switches (NC) and Binary Output (Code P)																																
1 6 with Inductive Limit Switches (NO) and Binary Output (Code P)																																
Pressure sensor																																
2 Standard (Supply 9, Output 138, Output 238)																																
Electrical connection																																
1 M20x1.5 (1x cable gland, 3x blanking plugs)																																
Housing material																																
0 Aluminum (standard)																																
1 Stainless steel																																
Special applications																																
0 Without																																
Additional certification																																
0 Without																																
Permissible ambient temperature for cable glands																																
0 -20°C ... +80 °C (plastics cable glands)																																
1 -40°C ... +80 °C (metallic cable glands)																																
2 -55°C ... +80 °C (metallic cable glands)																																
Function																																
0 Function																																
Display text in different languages																																
0 Standard (English, German, French)																																
Function																																
0 Without																																
Special version																																
0 Without																																
Function																																
0 0 Function																																
Hardware version																																
9 6 02.00.00																																
Software version																																
0 0 Standard																																

本页为证书附页，应与证书主页同时使用。



批准:

Signature

上海仪器仪表自控系统检验测试所有限公司

<http://www.sitiias.com.cn>

中国·上海·漕宝路103号200233

电话: +86 21 64518419



中国国家强制性产品认证证书

证书编号: 2024322307006083

证书附页: 第2页共2页

防爆标志:

Ex ia IIC T4/T6 Gb

电气参数:

Ui=17.5V, Ii=380mA, Pi=5.32W, Ci=5nF, Li=10μH

相关报告编号:

2024S17402-013926

使用条件:

1. 产品使用环境温度范围:

T4: -40°C~+80°C, T6: -40°C~+55°C

带感应限位开关时,

T4: -40°C~+70°C, T6: -40°C~+45°C

2. 产品外壳防护等级: IP66。

本页为证书附页，应与证书主页同时使用。



SITIiAS
Worldwide Access

批准:

上海仪器仪表自控系统检验测试所有限公司

<http://www.sitiias.com.cn>

中国·上海·漕宝路103号200233

电话: +86 21 64518419

16 Appendix A (configuration instructions)

16.1 Operation at the device, using TROVIS-VIEW or DD and FDI packages

Structure of the main display

Display/numbering	Description
0.1 ¹⁾	Reading of valve position in degrees
0.2	Reading of valve position in %
0.15	Reading of set point deviation in %
0.20	Reading of supply pressure in bar
0.30 ²⁾	Reading of status of pneumatic module in slot A
0.35 ²⁾	Reading of status of pneumatic module in slot B
0.40 ²⁾	Reading of status of option module in slot C
0.45 ²⁾	Reading of status of option module in slot D
0.50	Reading of generated messages
0.99	Press  to go to the menu level.

¹⁾ Reading only when the positioner has not yet been initialized

²⁾ Reading only in the event of an error

16.1.1 Main menu

Note

The availability of executed menu items and parameters depends on the positioner's configuration.

The readings shown for individual parameters and folders depend on the state of the positioner (initialized or not yet initialized) and hardware and software configuration of the positioner (e.g. installed pneumatic modules, parameter settings).

Parameters marked in the "Device" column with "-" only appear in the SAMSON TROVIS-VIEW software or DD/DTM/EDD in the specified 'On-site: write' and/or 'Diagnosis' user level.

Appendix A (configuration instructions)

Menu	Display reading	On-site: write	Integration	Adjustment range/values [default setting]/description
Main menu	•	•	•	
Current operating mode	–	•	•	Reading of the positioner's current operating mode
Target operating mode	1	•	•	<p>→ AUTO, SAFE, [MAN] Selecting the operating mode:</p> <ul style="list-style-type: none"> – AUTO: automatic mode – SAFE: fail-safe position – MAN: manual mode <p>Switchover from automatic to manual mode is bumpless. This parameter is indicated when the positioner has been initialized or not initialized with the MAN initialization mode.</p>
Set point (open-loop control)	2	•	•	<p>→ -90.0 to 90.0° [-30°] Enter the set point for the open-loop control mode. The reading in degrees is not absolute and only intended as a guide. Note: The open-loop control mode is active when the positioner that has not yet been initialized.</p>
Target mode (AOFB)	–	–	•	<p>→ [AUTO], MAN, Out of Service Select the required mode in the Actuator Output Function Block Operation using PROFINET®: TARGET_BLOCK_MODE in Actuator Output Function Block</p>
Current operating mode (AOFB)	–	–	•	<p>Indicates the current mode in the Actuator Output Function Block Operation using PROFINET®: CURRENT_MODE in Actuator Output Function Block</p>
Target operating mode (PB)	–	–	•	<p>→ [AUTO], Out of Service Select the required operating mode in the Physical Block. Operation using PROFINET®: TARGET_MODE in Physical Block</p>
Current operating mode (PB)	–	–	•	<p>Indicates the current mode in the Physical Block. Operation using PROFINET®: CURRENT_MODE in Physical Block</p>
Valve position	–	•	•	Reading of valve position in %
Manual set point (MAN)	3	•	•	<p>→ -25.0 to 125.0 % [0.0 %] The set point for manual mode (MAN) set with the rotary pushbutton. The current travel/angle is indicated in % when the positioner is initialized. Note: only when an initialized positioner is in the MAN operating mode.</p>
Reason for fail-safe position	4	•	•	<p>Reason for change to fail-safe position displayed. The parameter appears when the positioner is in the fail-safe position mode. Note: only when an initialized positioner is in the SAFE operating mode.</p>

Menu	Display reading	On-site: write	Integration	Adjustment range/values [default setting]/description
Change reading direction or Reading direction ¹⁾	5	•	•	→ [Reading direction], [Reading direction], Pneumatics (right)], Pneumatics (left) ¹⁾ Select the reading direction in the display
User level	6	–	–	→ [On-site: read], On-site: write On-site configuration at the positioner is unlocked (revoked if no settings are entered within five minutes).
Start-up	7	•	•	
Actuator	7.1	•	•	→ [Linear actuator], Rotary actuator, Linear actuator (expert) Select the actuator type: Linear actuator: the pin position (in mm) can be selected from the listed values in the 7.2 parameter. Rotary actuator: the '90°' pin position can be selected in the 'Pin position for rotary actuator' parameter. Linear actuator (expert): infinitely variable setting options for pin position (parameter in 7.4) and nominal range (parameter in 7.12)
Small actuator volume (≤0.36 l)	7.2	•	•	→ [No], Yes Parameter that can be selected for the operation with small actuators. The initialization is adapted accordingly for small actuator volumes. Note: 'Yes' applies to actuators with actuator areas ≤355 cm ² .
Pin position for rotary actuator or pin position ¹⁾	7.3	•	•	→ [90°], No lever Select the pin position. Do not select the 'No lever' setting. Note: Only with 'Actuator' = 'Rotary actuator'
Pin position for linear actuator (expert) or pin position ¹⁾	7.4	•	•	→ [10] to 655 mm Infinitely variable setting of the pin position Note: Only with 'Actuator' = 'Linear actuator (expert)'
Pin position	7.5	•	•	→ [None], 17, 25, 35, 50, 70, 100, 200 and 300 mm Enter the current position of the follower pin. The pin position depends on the rated travel of the linear actuator (see the 'Start-up and configuration' chapter). Note: Only with 'Actuator' = 'Linear actuator'
Pin position	7.6	•	•	→ [90°], No lever Enter the current position of the follower pin. The pin position depends on the nominal angle of the rotary actuator (see the 'Start-up and configuration' chapter). Note: Only with 'Actuator' = 'Rotary actuator'

Appendix A (configuration instructions)

Menu	Display reading	On-site: write	Integration	Adjustment range/values [default setting]/description
Pin position	7.7	•	•	→ [10] to 655 mm Enter the current position of the follower pin. The pin position depends on the rated travel of the linear actuator (see the 'Start-up and configuration' chapter). Note: Only with 'Actuator' = 'Linear actuator (expert)'
Nominal range for linear actuator or Nominal range ¹⁾	7.10	•	•	→ 14.0 to 70.7 mm Infinitely variable setting of the nominal range in mm The adjustment range depends on the pin position entered in 'Pin position for linear actuator'. Note: Only with 'Actuator' = 'Linear actuator'
Nominal range for rotary actuator or Nominal range ¹⁾	7.11	•	•	→ 24.0 to 100.0° [90°] Infinitely variable setting of the nominal range in degrees The adjustment range depends on the pin position entered in 'Pin position for rotary actuator'. Note: Only with 'Actuator' = 'Rotary actuator'
Nominal range for linear actuator (expert) or Nominal range ¹⁾	7.12	•	•	→ [3.6] to 999.0 mm Infinitely variable setting of the nominal range in mm The adjustment range depends on the pin position entered in 'Pin position for linear actuator (expert)'. Note: Only with 'Actuator' = 'Linear actuator (expert)'
Max. nom. range	7.16	•	•	Indicates the maximum possible nominal range. Note: only positioners initialized with NOM initialization mode and 'Pin position for linear actuator' ≠ 'None'.
Detected nominal range	7.17	•	•	Indicates the determined nominal range for rotary actuators. Note: only positioners initialized with MAX initialization mode and 'Pin position for rotary actuator' ≠ 'No lever'.
Fail-safe position	7.20	•	•	→ [Close], Open Select fail-safe position – Close: the valve is closed upon air supply failure. – Open: the valve is fully opened upon air supply failure. Operation using PROFINET®: ACTUATOR_ACTION in Actuator Transducer Block
Initialization mode	7.24	•	•	→ [MAX], NOM, MAN, SUB Select the initialization mode: – MAX: travel/angle of the closure member from the closed position to the opposite stop in the actuator – NOM: travel/angle of the closure member measured from the closed position to the specified rated travel – MAN: manually selected range – SUB: substitute calibration (without initialization) See the 'Start-up and configuration' chapter for details on initialization modes.

Menu	Display reading	On-site: write	Integration	Adjustment range/values [default setting]/description
Set point (open-loop control)	7.28	•	•	→ [-90.0] to 90.0° Set point for initialization with MAN initialization mode. The reading in degrees is not absolute and only intended as a guide. Note: Only when initialization mode = MAN.
Adopt valve position 1	7.29	•	•	→ Confirm the first end position of the valve (see the 'Start-up and configuration' chapter). Note: Only when initialization mode = MAN.
First valve position	7.30	•	•	Reading of the first end position of the valve (lever position in degrees) Note: Only when initialization mode = MAN.
Adopt valve position 2	7.31	•	•	→ Confirm the second end position of the valve (see the 'Start-up and configuration' chapter). Note: Only when initialization mode = MAN.
Second valve position	7.32	•	•	Reading of the second end position of the valve (lever position in degrees) Note: Only when initialization mode = MAN.
Current valve position	7.35	•	•	Reading of current valve position Note: Only when initialization mode = SUB.
Direction of rotation	7.36	•	•	→ Counterclockwise, [Clockwise] Determine the lever's direction of rotation for MAN initialization mode. For example: The valve closes when the plug stem moves downward. This action causes the positioner's lever to turn counterclockwise (when looking at the display, the pneumatic module on the right) → Setting: counterclockwise Note: Only when initialization mode = SUB.
Mounted device	7.50	•	•	→ [No device], Quick exhaust valve, Fast supply Indicates whether a mounted device for fast exhaust or supply has been installed in the hook-up. The parameter is reset during initialization if the positioner detected an external fast exhaust or supply function.
Output P3799 (primary)	7.53	•	•	→ [OUTPUT 138], OUTPUT 238 Select the primary output on which the diagnosis and valve signature are based (see the 'Start-up and configuration' chapter).
Pressure limit	7.58	•	•	→ 2.5 to 10 bar [7.0 bar] Enter value for pressure limit in bar. Do not activate pressure limitation for double-acting actuators (with fail-safe position AIR TO OPEN). Note: Only positioners with pressure sensors.

Appendix A (configuration instructions)

Menu	Display reading	On-site: write	Integration	Adjustment range/values [default setting]/description
Automatic software restriction setting	7.62	•	•	→ [Active], Not active If this setting is active, the software restriction is automatically set during initialization. The automatic software restriction setting must not be activated when a pneumatic volume booster is mounted on the control valve.
Software restriction (supply)	7.64	•	•	→ 25 to [100 %] The software restriction serves to adapt the air output capacity to the size of the actuator. The automatic software restriction must be manually adjusted if it is not activated (see the 'Start-up and configuration' chapter).
Software restriction (exhaust)	7.65	•	•	→ 25 to [100 %] The software restriction serves to adapt the air output capacity to the size of the actuator. The automatic software restriction must be manually adjusted if it is not activated (see the 'Start-up and configuration' chapter).
Initialization including valve signature	7.68	•	•	→ [Yes], No The valve signature is recorded after initialization is completed. In this case, the signal pressure is recorded together with the valve position and saved in the positioner as a reference value.
Start initialization	7.75	•	•	→ Confirm to start initialization During initialization, the valve moves through its travel range.
Stop initialization	–	•	•	→ Confirm to stop initialization
Start zero calibration	7.76	–	•	→ Confirm to start zero calibration During zero calibration, the valve moves through its travel range.
Result of last initialization	7.83	•	•	Indicates whether the last initialization was successfully completed. The reason why an unsuccessful initialization was canceled is indicated.
Result of last zero calibration	7.84	•	•	Indicates whether the last zero calibration was successfully completed. The reason why an unsuccessful zero calibration was canceled is indicated.
Result of last valve signature	7.85	•	•	Indicates whether the last valve signature was successfully completed. The reason why the recording of an unsuccessful valve signature was canceled is indicated.
Progress of initialization	–	–	•	Indicates the progress of initialization (in percent).
Initialization stage	7.34	–	•	Indicates the current initialization stage while initialization is in progress.
Initialization status	–	•	•	Indicates whether initialization is active or inactive.

Menu	Display reading	On-site: write	Integration	Adjustment range/values [default setting]/description
Zero calibration status	–	•	•	Indicates whether zero calibration is active or inactive.
Reset initialization	–	–	•	➔ Confirm to reset initialization
Current initialization	–	–	•	After initialization has been completed successfully, the values and settings used as the basis for the initialization are listed in the following parameters.
Initialization mode	–	–	•	After initialization starts, the values and settings used as the basis for the initialization are listed in the following parameters. Contrary to the [Valid initialization] folder, this list of values is saved even if the initialization is not completed successfully.
Actuator	–	–	•	Indicates the 'Actuator' parameter [7.1] specified for initialization.
Pin position	–	–	•	Indicates the 'Pin position' parameter [7.5, 7.6 or 7.7] specified for initialization.
Fail-safe position	–	–	•	Indicates the 'Fail-safe position' parameter [7.20] specified for initialization.
Output P3799 (primary)	–	–	•	Indicates the 'Output P3799 (primary)' parameter [7.53] specified for initialization.
Pressure limit	–	–	•	Indicates the 'Pressure limit' parameter [7.58] specified for initialization.
Dead time (supply)	–	–	•	Indicates the dead time (supply) during initialization in ms.
T63 (supply)	–	–	•	Indicates the time in ms it takes the valve to respond to a step change in signal (supply) from 0 to 63 %.
T86 (supply)	–	–	•	Indicates the time in ms it takes the valve to respond to a step change in signal (supply) from 0 to 86 %.
T98 (supply)	7.95.70	•	•	Indicates the time in ms it takes the valve to respond to a step change in signal (supply) from 0 to 98 %.
Dead time (exhaust)	–	–	•	Indicates the dead time (exhaust) during initialization in ms.
T63 (exhaust)	–	–	•	Indicates the time in ms it takes the valve to respond to a step change in signal (exhaust) from 0 to 63 %.
T86 (exhaust)	–	–	•	Indicates the time in ms it takes the valve to respond to a step change in signal (exhaust) from 0 to 86 %.
T98 (exhaust)	–	–	•	Indicates the time in ms it takes the valve to respond to a step change in signal (exhaust) from 0 to 98 %.
Direction of rotation	–	–	•	Indicates the 'Direction of rotation' parameter [7.36] specified for initialization.
Nominal range (optimized)	–	–	•	Indicates the nominal range measured with the activated speed-based end position.

Appendix A (configuration instructions)

Menu	Display reading	On-site: write	Integration	Adjustment range/values [default setting]/description
Detected nominal range	–	–	•	Indicates the nominal range for rotary actuators determined during initialization
Time stamp	–	–	•	Indicates time when the initialization was performed.
Temperature	–	–	•	Indicates the temperature inside the device determined during initialization.
Supply pressure	–	–	•	Indicates the supply pressure determined during initialization
Dead band (integral-action component)	–	–	•	Indicates the integral dead band determined during initialization
Kp (supply)	–	–	•	Indicates the proportional gain for supply determined during initialization.
Ki (supply)	–	–	•	Indicates the integral gain for supply determined during initialization.
Kd (supply)	–	–	•	Indicates the derivative gain for supply determined during initialization.
Kp (exhaust)	–	–	•	Indicates the proportional gain for exhaust determined during initialization.
Ki (exhaust)	–	–	•	Indicates the integral gain for exhaust determined during initialization.
Kd (exhaust)	–	–	•	Indicates the derivative gain for exhaust determined during initialization.
Deactivation time for large signal (supply)	–	–	•	Indicates the 'Deactivation time for large signal (supply)' parameter [8.7.45] specified for initialization.
Deactivation time for large signal (exhaust)	–	–	•	Indicates the 'Deactivation time for large signal (exhaust)' parameter [8.7.46] specified for initialization.
P3799 B: control mode	–	–	•	Indicates the control mode of pneumatic module B
Mounted device	–	–	•	Indicates the 'Mounted device' parameter [7.50] specified for initialization.
Automatic software restriction setting	–	–	•	Indicates the 'Automatic software restriction setting' parameter [7.62] specified for initialization.
Software restriction (supply)	–	–	•	Indicates the 'Software restriction (supply)' parameter [7.64] specified for initialization.
Software restriction (exhaust)	–	–	•	Indicates the 'Software restriction (exhaust)' parameter [7.65] specified for initialization.
Valid initialization	7.95	•	•	After initialization starts, the values and settings used as the basis for the initialization are listed in the following parameters. Contrary to the [Valid initialization] folder, this list of values is saved even if the initialization is not completed successfully.

Menu	Display reading	On-site: write	Integration	Adjustment range/values [default setting]/description
Actuator	7.95.1	•	•	Indicates the 'Actuator' parameter [7.1] specified for initialization.
Small actuator volume (≤0.36 l)	7.95.2	•	•	Indicates the 'Small actuator volume (≤0.36 l)' parameter [7.2] specified for initialization.
Pin position	7.95.5	•	•	Indicates the 'Pin position' parameter [7.5, 7.6 or 7.7] specified for initialization.
Software restriction (exhaust)	7.95.12	–	•	Indicates the 'Software restriction (exhaust)' parameter [8.7.32] specified for initialization.
Software restriction (supply)	7.95.13	–	•	Indicates the 'Software restriction (supply)' parameter [8.7.30] specified for initialization.
Min. transit time OPEN	7.95.15	–	•	Indicates the 'Transit time OPEN' parameter [8.1.20] specified during configuration Operation using PROFINET®: ACT_STROKE_TIME_INC in Actuator Transducer Block
Min. transit time CLOSE	7.95.16	–	•	Indicates the 'Transit time CLOSE' parameter [8.1.22] specified during configuration Operation using PROFINET®: ACT_STROKE_TIME_DEC in Actuator Transducer Block
Fail-safe position	7.95.20	–	•	Indicates the 'Fail-safe position' parameter [7.20] specified for initialization.
Valid initialization mode or initialization mode ¹⁾	7.95.24	–	•	Indicates the 'Initialization mode' parameter [7.24] specified for the last valid initialization.
Mounted device	7.95.50	–	•	Indicates the 'Mounted device' parameter [7.50] specified for initialization.
Output P3799 (primary)	–	–	•	Indicates the 'Output P3799 (primary)' parameter [7.20] specified for initialization.
Pressure limit	7.95.58	•	•	Indicates the 'Pressure limit' parameter [7.58] specified for initialization.
Automatic software restriction setting	7.95.62	–	•	Indicates the 'Automatic software restriction setting' parameter [7.62] specified for initialization.
Dead time (supply)	–	–	•	Indicates the dead time (in ms) for supply/to open the valve measured during initialization.
T63 (supply)	–	–	•	Indicates the supply/opening time (in ms) measured during initialization for a step change from 0 to 63 %.
T86 (supply)	–	–	•	Indicates the supply/opening time (in ms) measured during initialization for a step change from 0 to 86 %.
Dead time (exhaust)	–	–	•	Indicates the dead time (in ms) for exhaust/to close the valve measured during initialization.

Appendix A (configuration instructions)

Menu	Display reading	On-site: write	Integration	Adjustment range/values [default setting]/description
T63 (exhaust)	–	–	•	Indicates the exhaust/closing time (in ms) measured during initialization for a step change from 0 to 63 %.
T86 (exhaust)	–	–	•	Indicates the exhaust/closing time (in ms) measured during initialization for a step change from 0 to 86 %.
Direction of rotation	–	–	•	Indicates the 'Direction of rotation' parameter [7.36] specified for initialization.
Nominal range (optimized)	–	–	•	Indicates the nominal range measured with the activated speed-based end position.
Detected nominal range	–	–	•	Indicates the nominal range for rotary actuators determined during initialization
Time stamp	–	–	•	Indicates time when the initialization was performed.
Temperature	–	–	•	Indicates the temperature inside the device determined during initialization.
Supply pressure	–	–	•	Indicates the supply pressure determined during initialization
Dead band (integral-action component)	–	–	•	Indicates the integral dead band determined during initialization
Kp (supply)	7.95.82	•	•	Indicates the proportional gain for supply determined during initialization.
Ki (supply)	7.95.83	•	•	Indicates the integral gain for supply determined during initialization.
Kd (supply)	7.95.84	•	•	Indicates the derivative gain for supply determined during initialization.
Kp (exhaust)	7.95.89	•	•	Indicates the proportional gain for exhaust determined during initialization.
Ki (exhaust)	7.95.90	•	•	Indicates the integral gain for exhaust determined during initialization.
Kd (exhaust)	7.95.91	•	•	Indicates the derivative gain for exhaust determined during initialization.
Deactivation time for large signal (supply)	–	–	•	Indicates the 'Deactivation time for large signal (supply)' parameter [8.7.45] specified for initialization.
Deactivation time for large signal (exhaust)	–	–	•	Indicates the 'Deactivation time for large signal (exhaust)' parameter [8.7.46] specified for initialization.
P3799 B: control mode	–	–	•	Indicates the control mode used for the second pneumatic module (e.g. booster when two pneumatic modules are used)
Mounted device	–	–	•	Indicates the 'Mounted device' parameter [7.50] specified for initialization.

Menu	Display reading	On-site: write	Integration	Adjustment range/values [default setting]/description
Automatic software restriction setting	–	–	•	Indicates the 'Automatic software restriction setting' parameter [7.62] specified for initialization.
Software restriction (supply)	–	–	•	Indicates the 'Software restriction (supply)' parameter [7.64] specified for initialization.
Software restriction (exhaust)	–	–	•	Indicates the 'Software restriction (exhaust)' parameter [7.65] specified for initialization.
Configuration	8	•	•	
Language	–	–	•	→ [None], DE, EN, FR Language used on the positioner display
Behavior upon failure of the travel sensing	–	–	•	→ [Emergency mode], Fail-safe position Select how the positioner is to behave when the travel sensing fails. – Emergency mode: the positioner behaves as if it is not initialized (open-loop control) – Fail-safe position: the positioner moves the valve to the defined fail-safe position (see 7.20 parameter)
Activate password	–	–	•	On-site: write: indicates whether the password is activated or not. Diagnosis: activate/deactivate the password to lock on-site operation
Change password	–	–	•	→ 0000 to 9999, [1234] → Enter the password.
Set point processing	8.1	•	•	
Characteristic	8.1.9	•	•	→ [Linear], Equal percentage, Reverse equal percentage, Butterfly valve (linear), Butterfly valve (equal percentage), Rotary plug valve (linear), Rotary plug valve (equal percentage), Segmented ball valve (linear), Segmented ball valve (equal percentage), User-defined Select the characteristic (see Chapter 16.3).
Lower x-range value	8.1.12	•	•	→ [0.0] to 99.0 % Lower range value for travel/angle in nominal or operating range The operating range is the actual travel/angle of the valve and is limited by the lower travel/angle range value and the upper travel/angle range value. Usually, the operating range and the nominal range are identical. The nominal range can be limited to the operating range by the lower and upper x-range values. The value is displayed or must be entered. The characteristic is adapted. The difference between the lower and upper x-range values must be at least 1 %.

Appendix A (configuration instructions)

Menu	Display reading	On-site: write	Integration	Adjustment range/values [default setting]/description
Upper x-range value	8.1.13	•	•	<p>→ 1.0 to [100.0 %]</p> <p>Upper range value for travel/angle in nominal or operating range</p> <p>The value is displayed or must be entered.</p> <p>The characteristic is adapted.</p> <p>Example: The operating range is modified, for example to limit the range of a control valve which has been sized too large. For this function, the entire resolution range of the set point is converted to the new limits.</p> <p>0 % on the display corresponds to the adjusted lower limit and 100 % to the adjusted upper limit.</p> <p>The difference between the lower and upper x-range values must be at least 1 %.</p>
Transit time OPEN	8.1.20	•	•	<p>→ [0.0] to 10000.0 s</p> <p>Time required by the valve to move through its working range with an increasing set point.</p> <p>For some applications it is recommendable to limit the transit time of the actuator to prevent it from engaging too fast in the running process.</p>
Transit time CLOSE	8.1.22	•	•	<p>→ [0.0] to 10000.0 s</p> <p>Time required by the valve to move through its working range with a set point to open the valve.</p>
Travel/sec. (rising)	8.1.25	–	–	<p>→ 1.0 to 100.0 % [10.0 %]</p> <p>Required travel change in % per second</p>
Travel/sec. (falling)	8.1.27	–	–	<p>→ 1.0 to 100.0 % [10.0 %]</p> <p>Required travel change in % per second</p>
Lower end position	8.1.40	•	•	<p>→ [Active], Not active</p> <p>Activate/deactivate the 'End position w <=' (set point cutoff decrease) parameter</p> <p>A tight-closing of the valve is only effective when 'Lower end position' = 'Active'.</p>
End position w <= (set point cutoff decrease)	8.1.41	•	•	<p>→ 0.0 to 49.0 % [1.0 %]</p> <p>If the set point w reaches up to the entered percentage at the final value that causes the valve to close, the actuator is immediately completely vented (with AIR TO OPEN) or filled with air (with AIR TO CLOSE). This action always lead to maximum tight-closing of the valve.</p> <p>Note: Parameter only active when 'Lower end position' = 'Active'.</p>

Menu	Display reading	On-site: write	Integration	Adjustment range/values [default setting]/description
Upper end position	8.1.44	•	•	→ Active, [Not active] Activate/deactivate the 'End position w >=' (set point cutoff increase) parameter For three-way valves, the following must apply: 'Upper end position' = 'Active'.
End position w >= (set point cutoff increase)	8.1.45	•	•	→ 51.0 to 100.0 % [99.0 %] If the set point w reaches up to the entered percentage at the final value that causes the valve to open, the actuator is immediately filled with air (with AIR TO OPEN) or completely vented (with AIR TO CLOSE). This action leads to the valve being completely opened when it is working properly. Example: set the 'End position w >=' (set point cutoff increase) parameter to 99 % for three-way valves. Note: Parameter only active when 'Upper end position' = 'Active'.
Lower range value of set point scaling ²⁾	–	–	•	Indicates the defined lower range value of the set point range. Operation using PROFINET®: PV_SCALE in Actuator Output Function Block (lower range value)
Upper range value of set point scaling ²⁾	–	–	•	Indicates the defined upper range value of the set point range. Operation using PROFINET®: PV_SCALE in Actuator Output Function Block (upper range value)
Decimal places of set point scaling ²⁾	–	–	•	Indicates the defined decimal places of the set point range. Operation using PROFINET®: PV_SCALE in Actuator Output Function Block (decimal places)
Unit of set point scaling ²⁾	–	–	•	Indicates the defined unit of the set point range. Operation using PROFINET®: PV_SCALE in Actuator Output Function Block (unit)
Lower range value of output value scale	–	–	•	Indicates the defined lower range value of the travel/angle range. Operation using PROFINET®: OUT_SCALE in Actuator Output Function Block (lower range value)
Upper range value of output value scale	–	–	•	Indicates the defined upper range value of the travel/angle range. Operation using PROFINET®: OUT_SCALE in Actuator Output Function Block (upper range value)
Decimal places of output value scale	–	–	•	Indicates the defined decimal places of the travel/angle range. Operation using PROFINET®: OUT_SCALE in Actuator Output Function Block (decimal places)

Appendix A (configuration instructions)

Menu	Display reading	On-site: write	Integration	Adjustment range/values [default setting]/description
Unit of output value scale	–	–	•	Indicates the defined unit of the travel/angle range. Operation using PROFINET®: OUT_SCALE in Actuator Output Function Block (unit)
Direction of action	–	–	•	Indicates the selected direction of action, i.e. how the set point is assigned to the controlled variable. Operation using PROFINET®: INCREASE_CLOSE in Actuator Output Function Block (unit)
Limit of discrete CLOSED valve position	8.1.12	–	•	→ 0.0 to 49.9 % [5.0 %] Setting of the closed position when the positioner has not been initialized (discrete analysis)
Limit of discrete OPEN valve position	8.1.13	–	•	→ 50.0 to 100.0 % [95.0 %] Setting of the open position when the positioner has not been initialized (discrete analysis)
Identification	8.2	•	•	
Positioner	8.2.1	•	•	
Article code	–	–	•	Reading of the positioner article code The article code helps identify the positioner version (see the 'Markings on the device' chapter).
Certification	–	–	•	Indicates whether the positioner has a valid explosion protection certificate.
Order number and order position	–	–	•	Indicates the order number and position when the positioner was ordered (operator details on ordering).
Control valve ID	–	–	•	Indicates the ID of the control valve on which the positioner is mounted (operator details on ordering).
Firmware version	8.2.1.5	•	•	Reading of the positioner firmware version
Hardware version	8.2.1.6	•	•	Reading of the positioner hardware version
Serial number	8.2.1.7	•	•	Reading of the positioner serial number
Order code	–	–	•	Reading of positioner order code Operation using PROFINET®: OrderID in Physical Block
Configuration ID assigned to the electronics unit	–	–	•	Indicates the material number assigned to the electronics unit installed in the positioner.
Device tag	–	–	•	Indicates the device ID used to identify the control valve and its task/function (part of the tag number) Operation using PROFINET®: IM_Tag_Function in Physical Block

Menu	Display reading	On-site: write	Integration	Adjustment range/values [default setting]/description
Tag number	–	–	•	Indicates the tag number used to identify the control valve and its task/function Operation using PROFINET®: IM_Tag_Function in Physical Block
Manufacturer	–	–	•	Reading of positioner manufacturer Operation using PROFINET®: DEVICE_Man_ID in Physical Block
Configuration counter	–	–	•	Reading of number of configuration changes to static parameters Operation using PROFINET®: IM_Revision_Counter in Physical Block
Profile	–	–	•	Reading of profile information TROVIS 3797 ID: 0xB310, profile ID: 0x9700 Operation using PROFINET®: IM_Profile_ID in Physical Block
Profile-specific block type	–	–	•	Reading of the profile-specific block type Operation using PROFINET®: IM_Profile_Counter in Physical Block
Description	–	–	•	Input option for user-defined text Operation using PROFINET®: IM_Descriptor in Physical Block
Date of installation	–	–	•	Reading of the installation date Operation using PROFINET®: IM_Date in Physical Block
Last change	–	–	•	Time reading of the last change to a static parameter Operation using PROFINET®: LATEST_CHANGE in Physical Block
Text box 1	–	–	•	Empty text boxes to enter information on the positioner, control valve and/or tag (max. 32 characters)
Text box 2	–	–	•	
Text box 3	–	–	•	
Text box 4	–	–	•	
Text box 5	–	–	•	
Valve	–	–	•	
Valve manufacturer	–	–	•	Option to enter valve manufacturer (max. 32 characters)
Description	–	–	•	Option to enter description of the valve (max. 32 characters)

Appendix A (configuration instructions)

Menu	Display reading	On-site: write	Integration	Adjustment range/values [default setting]/description	
Valve type	-	-	•	→ Linear moving valve, Sliding valve, Rotary moving valve, Part-turn, Rotary slide valve, Multi-turn [Undefined]	Option to enter valve information
Valve size standard	-	-	•	→ DIN, ANSI, IG, JIS, BS, Other (mm), Other (in), [-/-]	
Nominal size DN	-	-	•	→ [0.0] to 65535.0	
Flow direction	-	-	•	→ Flow-to-open, Flow-to-close, Alternating, [-/-]	
Max. cycle count	-	-	•	→ 0 to 1000000000, [1000000]	
Pressure balancing	-	-	•	→ Without, With (PTFE), With (graphite), Other, [-/-]	
Facing (leakage class)	-	-	•	→ Metal seal, Lapped-in, Soft seal, Nickel seal, PTFE, PEEK, UHMWPE, FFKM, UHMWPE (polyethylene), Other, [-/-]	Option to enter valve information
Valve seat diameter	-	-	•	→ [0.0] to 600.0 mm	
Kvs	-	-	•	→ [0.0] to 10000.00	
Kvs unit	-	-	•	→ Kv coefficient, Tv, Other, [-/-]	
Plug type	-	-	•	→ Parabolic, V-port, Other, [-/-]	
Valve characteristic	-	-	•	→ Linear, Equal percentage, Inherent, Other, [-/-]	
Noise reduction	-	-	•	→ None, St I, St II, St III, Other, [-/-]	
Actuator	-	-	•		
Actuator manufacturer	-	-	•	Option to enter actuator manufacturer (max. 32 characters)	
Description	-	-	•	Option to enter description of the actuator (max. 32 characters)	
Actuator motion	-	-	•	→ Linear motion, Rotary motion, Other, [-/-]	Option to enter actuator information
Principle of operation	-	-	•	→ Single acting, Double acting, Other, [-/-]	
Actuator type	-	-	•	→ Pneumatic (diaphragm), Pneumatic (piston), Hydraulic, Electric, Other, [-/-]	
Effective actuator area	-	-	•	→ [0] to 65535 cm ²	
Lower signal pressure range value	-	-	•	→ [0.0] to 65535.0 bar	
Upper signal pressure range value	-	-	•	→ [0.0] to 65535.0 bar [1.0 bar]	

Menu	Display reading	On-site: write	Integration	Adjustment range/values [default setting]/description
Fail-safe position	–	–	•	→ Air-to-open (ATO), Air-to-close (ATC), Other, [-/-] Option to enter actuator information
Supply pressure	–	–	•	→ [0.0] to 14.0 bar
Further valve accessories	–	–	•	
Manufacturer	–	–	•	Option to enter manufacturer of valve accessories (max. 32 characters)
Description	–	–	•	Option to enter description of the valve accessories (max. 32 characters)
Control parameters	8.7	•	•	
Activate integral-action component	8.7.1	•	•	→ [Active] (PID), Not active (PD) The control mode can be changed from PD to PID controller and vice versa. The integral action of the PID controller is always activated after initialization has been completed successfully. It can be deactivated by this parameter. After it is deactivated, the positioner merely works as a PD controller. As a result, the positioner responds more slowly or not at all to very small set point deviations. We recommend activating integral action for very precise closed-loop control.
Dead band (integral-action component)	8.7.2	•	•	→ [0.1] to 100.0 % Integral dead band for closed-loop control The integral action stops when the set point deviation enters this dead band. The integral action restarts when the valve position leaves the dead band again. The adaptation is carried out automatically during closed-loop control (depending on the friction).
Deactivation of integral action in upper end position	8.7.3	•	•	→ 0 to 25 % [1.0 %] The integral action stops when the valve position is above this limit. The integral action is no longer included in closed-loop control if a steady-state error arises around the upper end position (e.g. increased friction, end position cannot be reached). The integral action restarts when the valve position leaves the described range again. Example: if this parameter is set to 1 %, the integral action stops for valve positions >99 %.

Appendix A (configuration instructions)

Menu	Display reading	On-site: write	Integration	Adjustment range/values [default setting]/description
Deactivation of integral action in lower end position	8.7.4	•	•	<p>→ 0 to 25 % [1.0 %]</p> <p>The integral action stops when the valve position is below this limit.</p> <p>The integral action is no longer included in closed-loop control if a steady-state error arises around the lower end position (e.g. increased friction, end position cannot be reached). The integral action restarts when the valve position leaves the described range again.</p> <p>Example: if this parameter is set to 1 %, the integral action stops for valve positions <1 %.</p>
Kp (supply)	8.7.15	•	•	<p>→ [3.5] to 100</p> <p>Setting of the proportional gain for supply</p> <p>During positioner initialization, the parameters of the PID controller are optimally tuned. If the valve oscillates at a position, lowering the Kp after initialization can lead to an improvement.</p> <p>Check the integral and derivative action for their correct response after adjusting Kp.</p>
Ki (supply)	8.7.16	•	•	<p>→ 0.1 to 3.0 [0.8]</p> <p>Setting of the integral gain for supply</p> <p>During positioner initialization, the parameters of the PID controller are optimally tuned. If the error is too large in steady state, increasing the Ki after initialization can lead to an improvement.</p> <p>Check the proportional and derivative action for their correct response after adjusting Ki.</p>
Kd (supply)	8.7.17	•	•	<p>→ 0.5 to 100.0 [20.0]</p> <p>Setting of the derivative gain for supply</p> <p>During positioner initialization, the parameters of the PID controller are optimally tuned. If the valve oscillates at a position, raising the Kd after initialization can lead to an improvement.</p> <p>Check the proportional and integral action for their correct response after adjusting Kp.</p>
Kp (exhaust)	8.7.22	•	•	<p>→ [3.5] to 100.0</p> <p>Setting of the proportional gain for exhaust</p> <p>During positioner initialization, the parameters of the PID controller are optimally tuned. If the valve oscillates at a position, lowering the Kp after initialization can lead to an improvement.</p> <p>Check the integral and derivative action for their correct response after adjusting Kp.</p>

Menu	Display reading	On-site: write	Integration	Adjustment range/values [default setting]/description
Ki (exhaust)	8.7.23	•	•	<p>→ 0.1 to 3.0 [0.8]</p> <p>Setting of the integral gain for exhaust</p> <p>During positioner initialization, the parameters of the PID controller are optimally tuned. If the error is too large in steady state, increasing the Ki after initialization can lead to an improvement.</p> <p>Check the proportional and derivative action for their correct response after adjusting Ki.</p>
Kd (exhaust)	8.7.24	•	•	<p>→ 0.5 to 100.0 [20.0]</p> <p>Setting of the derivative gain for exhaust</p> <p>During positioner initialization, the parameters of the PID controller are optimally tuned. If the valve oscillates at a position, raising the Kd after initialization can lead to an improvement.</p> <p>Check the proportional and integral action for their correct response after adjusting Kp.</p>
Software restriction (supply)	8.7.30	•	•	<p>→ 25 to 100 %</p> <p>Setting of the supply flow rate restriction in % of the pneumatic module (slot A)</p> <p>The supply flow rate of the pneumatic modules is reduced to the specified value. A reduction of the flow rate may lead to a better control accuracy for small actuators.</p>
Software restriction (exhaust)	8.7.32	•	•	<p>→ 25 to 100 %</p> <p>Setting of the exhaust flow rate restriction in % of the pneumatic module (slot A)</p> <p>The exhaust flow rate of the pneumatic modules is reduced to the specified value. A reduction of the flow rate may lead to a better control accuracy for small actuators.</p>
Activation threshold for large signal (supply)	8.7.35	•	•	<p>→ 1.0 to 100.0 % [5.0 %]</p> <p>This parameter can be set after initialization is completed.</p> <p>The small-signal mode is active for small errors for supply below the activation threshold. The large-signal mode is activated after the error for supply exceeds the activation threshold.</p> <p>The large-signal mode is activated to respond to small errors if the threshold is too low. This can lead to unwanted oscillations.</p>
Activation threshold for large signal (exhaust)	8.7.36	•	•	<p>→ 1.0 to 100.0 % [5.0 %]</p> <p>This parameter can be set after initialization is completed.</p> <p>The small-signal mode is active for small errors for exhaust below the activation threshold. The large-signal mode is activated after the error for supply exceeds the activation threshold.</p> <p>The large-signal mode is activated to respond to small errors if the threshold is too low. This can lead to unwanted oscillations.</p>

Appendix A (configuration instructions)

Menu	Display reading	On-site: write	Integration	Adjustment range/values [default setting]/description
Deactivation time for large signal (supply)	8.7.45	•	•	<p>→ [0] to 32767 ms</p> <p>Time in ms until activation of the large-signal mode (supply)</p> <p>If it takes longer for the supply signal to reach the set point than the expected time (taking the current velocity into account), the large-signal mode is deactivated.</p> <p>The time is optimized during initialization for steps of 50 % in the middle travel range.</p> <p>Overshooting may occur if the time selected is too short. The large-signal mode is used optimally if the time selected is too long.</p>
Deactivation time for large signal (exhaust)	8.7.46	•	•	<p>→ [0] to 32767 ms</p> <p>Time in ms until activation of the large-signal mode (exhaust)</p> <p>If it takes longer for the exhaust signal to reach the set point than the expected time (taking the current velocity into account), the large-signal mode is deactivated.</p> <p>The time is optimized during initialization for steps of 50 % in the middle travel range.</p> <p>Overshooting may occur if the time selected is too short. The large-signal mode is used optimally if the time selected is too long.</p>
End position (optimized)	8.7.70	•	•	<p>→ [Active], Not active</p> <p>This parameter only applies to the end position (supply) with MAX initialization mode and an air-to-open (ATO) actuator. In all other cases, this function is deactivated.</p> <p>During initialization, an optimal and a mechanical end position is calculated based on an analysis of the motion speed. The optimized end position is used if the distance is small enough.</p> <p>We recommend only activating this function when a mechanical deformation of the actuator is explicitly specified. In this case, it leads to a higher error in the end position. As a result, the control accuracy worsens.</p>
Control-loop OPEN (EXPERT)	8.7.90	•	•	Adjustment range/value: parameter for improving the control-loop operation during disruptions when operated with small actuators.
Control-loop CLOSE (EXPERT)	8.7.91	•	•	Adjustment range/value: parameter for improving the control-loop operation during disruptions when operated with small actuators.

Menu	Display reading	On-site: write	Integration	Adjustment range/values [default setting]/description
Slot options				
Forced venting switch	8.10.1	•	•	Indicates whether the forced venting option is installed and in which slot
P3799 A: status	8.10.2	•	•	Status reading of the pneumatic module in slot A
Identification	–	•	•	Reading of the pneumatic module's function in slot A → [Unknown], Double-acting, Single-acting OUTPUT 138, Single-acting OUTPUT 238, Fail-in-place module
P3799 B: status	8.10.8	•	•	Status reading of the pneumatic module in slot B
Identification	–	•	•	Reading of the pneumatic module's function in slot B → [Unknown], Double-acting, Single-acting OUTPUT 138, Single-acting OUTPUT 238, Fail-in-place module
Status Z3799 C	–	•	•	→ No module inserted Parameter in the TROVIS 3797 Positioner without any function
Status Z3799 D	–	•	•	→ No module inserted Parameter in the TROVIS 3797 Positioner without any function
Pressure sensors				
Pressure sensors installed	8.10.46.1	•	•	Indicates whether the positioner has pressure sensors or not.
Pressure sensors exist	–	•	•	Indicates whether the positioner has pressure sensors or not.
OUTPUT 138: pressure	8.10.46.2	•	•	Pressure in bar at the positioner's output 138 Note: Only when 'Pressure sensors exist' = 'Yes'
OUTPUT 238: pressure	8.10.46.3	•	•	Pressure in bar at the positioner's output 238 Note: Only when 'Pressure sensors exist' = 'Yes'
Supply pressure	8.10.46.4	•	•	Supply pressure in bar at the input (supply 9) Note: Only when 'Pressure sensors exist' = 'Yes'
Block configuration				
8.30				
Positioner				
Current operating mode	–	–	•	Reading of the positioner's operating mode
Target operating mode	–	–	•	→ SAFE, [AUTO], MAN Target operating mode of the positioner
Physical Block				
8.30.3				
Language	–	–	•	→ String with max. 2 characters Input option for user-defined text (recommended language code according to ISO 639-1, e.g. de, en) Operation using PROFINET®: LANGUAGE in Physical Block

Appendix A (configuration instructions)

Menu	Display reading	On-site: write	Integration	Adjustment range/values [default setting]/description
Target operating mode (PB)	–	–	•	<p>→ [AUTO], Out of Service</p> <p>Target operating mode of the Physical Block: the CURRENT_MODE directly follows the TARGET_MODE. Device alarms are suppressed in the 'Out of service' mode.</p> <p>Operation using PROFINET®: TARGET_MODE in Physical Block</p>
Current operating mode (PB)	–	–	•	<p>Indicates current operating mode of the Physical Block</p> <p>Operation using PROFINET®: CURRENT_MODE in Physical Block</p>
Start-up settings	8.30.3.4	•	•	<p>Indicates the validity of start-up parameter settings (parameter setting over PROFINET® operation)</p> <p>Operation using PROFINET®: STARTUP_PARAM_VALIDITY in Physical Block</p>
Type of confirmation upon parameter changes	–	–	•	<p>→ [Automatically confirmed after 20 seconds], Confirmed manually</p> <p>Setting to determine whether parameter changes are to be automatically adopted or must be manually confirmed beforehand.</p> <p>Operation using PROFINET®: UPDATE_EVENT_MODE in Physical Block</p>
Confirm parameter change	–	–	•	<p>Manual confirmation after a parameter change</p> <p>Note: only effective when 'Type of confirmation upon parameter changes' = "Manual"</p>
Alarm delay	–	–	•	<p>→ [0] to 65535 s</p> <p>Filter for brief alarm events An alarm event must be active for at least the time defined in 'Alarm delay' to generate a diagnostic event.</p> <p>Operation using PROFINET®: ALARM_DELAY in Physical Block</p>
Order code	–	–	•	<p>Reading of positioner order code</p> <p>Operation using PROFINET®: OrderID in Physical Block</p>
Firmware version	8.30.3.10	•	•	<p>Reading of the positioner firmware version</p> <p>Operation using PROFINET®: SOFTWARE_REVISION in Physical Block</p>
Hardware version	8.30.3.11	•	•	<p>Reading of the positioner hardware version</p> <p>Operation using PROFINET®: HARDWARE_REVISION in Physical Block</p>

Menu	Display reading	On-site: write	Integration	Adjustment range/values [default setting]/description
Device tag	–	–	•	➔ String with max. 32 characters Input option for user-defined text Operation using PROFINET®: IM_Tag_Function in Physical Block
Manufacturer	–	–	•	Reading of positioner manufacturer Operation using PROFINET®: DEVICE_Man_ID in Physical Block
Serial number	8.30.3.16	•	•	Reading of the positioner serial number Operation using PROFINET®: IM_Serial_Number in Physical Block
Device location	–	–	•	➔ String with max. 32 characters Input option for user-defined text Operation using PROFINET®: IM_Tag_Location in Physical Block
Configuration counter	–	–	•	Reading of number of configuration changes to static parameters Operation using PROFINET®: IM_Revision_Counter in Physical Block
Profile	–	–	•	Reading of profile information TROVIS 3797 ID: 0xB310, profile ID: 0x9700 Operation using PROFINET®: IM_Profile_ID in Physical Block
Profile-specific block type	–	–	•	Reading of the profile-specific block type Operation using PROFINET®: IM_Profile_Counter in Physical Block
Description	–	–	•	➔ String with max. 54 characters Input option for user-defined text Operation using PROFINET®: IM_Descriptor in Physical Block
Date of installation	–	–	•	➔ String with max. 16 characters Date entries can be overwritten. Operation using PROFINET®: IM_Date in Physical Block
Last change	–	–	•	➔ String with max. 16 characters Date entries can be overwritten. Operation using PROFINET®: LATEST_CHANGE in Physical Block

Appendix A (configuration instructions)

Menu	Display reading	On-site: write	Integration	Adjustment range/values [default setting]/description
Write protection	8.30.3.35	•	•	→ [Deactivated], Hardware write protection activated, Write protection with password activated Activate/deactivate write protection Note: the target operating mode and the output value are not affected by the write protection. Operation using PROFINET®: WRITE_PROTECTION in Physical Block
Actuator Output Function Block	8.30.4	•	•	
Target mode (AOFB)	–	–	•	→ [AUTO], MAN, Out of Service Select the required mode in the Actuator Output Function Block Operation using PROFINET®: AOFAB_TARGET_BLOCK_MODE in Actuator Output Function Block
Current operating mode (AOFB)	–	–	•	Indicates the current mode in the Actuator Output Function Block Operation using PROFINET®: AOFAB_CURRENT_BLOCK_MODE in Actuator Output Function Block
Unit of actual value	–	–	•	Reading of actual value unit Operation using PROFINET®: READBACK_UNITS in Actuator Output Function Block
Tag number	–	–	•	Indicates the tag number used to identify the control valve and its task/function (parameter setting over PROFINET® operation) Operation using PROFINET®: IM_Tag_Function (AOFB) in Actuator Output Function Block
Unlock on-site operation	3.30.4.6	•	•	Indicates whether the on-site operation is permitted or not (parameter setting over PROFINET® operation) Operation using PROFINET®: LOCAL_OP_ENA in Actuator Output Function Block Note: on-site operation is automatically enabled upon communication failure lasting longer than 30 seconds.
Simulation	8.30.4.9	•	•	→ [No], Yes Enable simulation Operation using PROFINET®: SIMULATE_ENABLE in Actuator Output Function Block
Simulation value	8.30.4.10	•	•	Enter the simulation value for the current valve position → [0.0 %]; Unrestricted value range Operation using PROFINET®: SIMULATE_VALUE in Actuator Output Function Block

Menu	Display reading	On-site: write	Integration	Adjustment range/values [default setting]/description
Simulated status	8.30.4.11	•	•	<p>→ BAD – maintenance alarm, BAD – function check / local override, UNCERTAIN – maintenance demanded, UNCERTAIN – process related, no maintenance, [GOOD – ok]</p> <p>Enter the simulated status for the current valve position</p> <p>Operation using PROFINET®: SIMULATE_STATUS in Actuator Output Function Block</p>
Upper range value of set point scaling ²⁾	–	–	•	<p>Indicates the defined upper range value of the set point range (parameter setting over PROFINET® operation)</p> <p>Operation using PROFINET®: PV_SCALE in Actuator Output Function Block (upper range value)</p>
Lower range value of set point scaling ²⁾	–	–	•	<p>Indicates the defined lower range value of the set point range (parameter setting over PROFINET® operation)</p> <p>Operation using PROFINET®: PV_SCALE in Actuator Output Function Block (lower range value)</p>
Unit of set point scaling ²⁾	–	–	•	<p>Indicates the defined unit of the set point range (parameter setting over PROFINET® operation)</p> <p>Operation using PROFINET®: PV_SCALE in Actuator Output Function Block (unit)</p>
Decimal places of set point scaling ²⁾	–	–	•	<p>Indicates the defined decimal places of the set point range (parameter setting over PROFINET® operation)</p> <p>Operation using PROFINET®: PV_SCALE in Actuator Output Function Block (decimal places)</p>
Upper range value of output value scale	–	–	•	<p>Indicates the defined upper range value of the travel/angle range (parameter setting over PROFINET® operation)</p> <p>Operation using PROFINET®: OUT_SCALE in Actuator Output Function Block (upper range value)</p>
Lower range value of output value scale	–	–	•	<p>Indicates the defined lower range value of the travel/angle range (parameter setting over PROFINET® operation)</p> <p>Operation using PROFINET®: OUT_SCALE in Actuator Output Function Block (lower range value)</p>
Unit of output value scale	–	–	•	<p>Indicates the defined unit of the travel/angle range (parameter setting over PROFINET® operation)</p> <p>Operation using PROFINET®: OUT_SCALE in Actuator Output Function Block (unit)</p>

Appendix A (configuration instructions)

Menu	Display reading	On-site: write	Integration	Adjustment range/values [default setting]/description
Decimal places of output value scale	–	–	•	Indicates the defined decimal places of the travel/angle range (parameter setting over PROFINET® operation) Operation using PROFINET®: OUT_SCALE in Actuator Output Function Block (decimal places)
Direction of action	–	–	•	Indicates the selected direction of action, i.e. how the set point is assigned to the controlled variable (parameter setting over PROFINET® operation) Operation using PROFINET®: INCREASE_CLOSE in Actuator Output Function Block (unit)
Failure behavior	–	–	•	→ Fixed value, last valid value, [Fail-safe position] Defined failure behavior (reaction to a detected error of the set point valid in the current operating mode after the failure behavior delay (FSAFE_TIME) has elapsed): – Fixed value: control to FSAFE_VALUE (adjustable in operation over PROFINET®) – Last valid value: control to the last valid set point (status of the OUT parameter is set to UNCERTAIN) – Fail-safe position: the actuator moves to the fail-safe position defined in the ACTOR_ACTION parameter (the status of OUT parameter is set to BAD) Operation using PROFINET®: FSAFE_TYPE in Actuator Output Function Block
Delay time	–	–	•	→ [0.0] to 3600 s Time that it takes from detection of an error of the set point valid in the current operating mode until the failure behavior is triggered: the failure behavior (FSAFE_TYPE) is triggered after the failure behavior delay (FSAFE_TIME) has elapsed and the error still exists. Operation using PROFINET®: FSAFE_TIME in Actuator Output Function Block
Set point	8.30.4.24	•	•	Indicates the required valve position within the nominal range in automatic mode (parameter setting over PROFINET® operation) Operation using PROFINET®: SP Value in Actuator Output Function Block
Set point status	8.30.4.25	•	•	Status reading of set point Operation using PROFINET®: SP Value in Actuator Output Function Block
Output value of AO Block	8.30.4.26	•	•	Indicates output value of the Actuator Output Function Block Operation using PROFINET®: OUT Value in Actuator Output Function Block

Menu	Display reading	On-site: write	Integration	Adjustment range/values [default setting]/description
Output value status of AO Block	8.30.4.27	•	•	Indicates output value status of the Actuator Output Function Block Operation using PROFINET®: OUT Status in Actuator Output Function Block
Set point deviation (target position – valve position)	–	–	•	Indicates the error in % Operation using PROFINET®: SETP_DEVIATION in Actuator Output Function Block
Actual value	–	–	•	Actual value reading Operation using PROFINET®: READBACK Value in Actuator Output Function Block
Status of actual value	–	–	•	Status reading of actual value Operation using PROFINET®: READBACK Status in Actuator Output Function Block
Discrete valve position	–	–	•	Reading of the discrete valve position (set point when the positioner has not yet been initialized) Operation using PROFINET®: POS_D Value in Actuator Output Function Block
Status of discrete valve position	–	–	•	Status reading of the discrete valve position Operation using PROFINET®: POS_D Status in Actuator Output Function Block
Supported checkback information	–	–	•	Indicates supported checkback information (parameter setting over PROFINET® operation) Operation using PROFINET®: CHECK_BACK_MASK in Actuator Output Function Block
Checkback information CB_FAIL_SAFE	–	–	•	Fail-safe position: The fail-safe position has been triggered. Possible causes: – The SAFE mode has been selected. – Active failure behavior after communication failure – Active failure behavior after a set point (SP) with BAD status Operation using PROFINET®: CHECK_BACK Bit0 in Actuator Output Function Block
Checkback information CB_REQ_LOC_OP	–	–	•	Target operating mode MAN or SAFE Operation using PROFINET®: CHECK_BACK Bit1 in Actuator Output Function Block
Checkback information CB_LOCAL_OP	–	–	•	Current operating mode MAN or SAFE Operation using PROFINET®: CHECK_BACK Bit2 in Actuator Output Function Block
Checkback information CB_DISC_DIR	–	–	•	An offset exists. Operation using PROFINET®: CHECK_BACK Bit4 in Actuator Output Function Block

Appendix A (configuration instructions)

Menu	Display reading	On-site: write	Integration	Adjustment range/values [default setting]/description
Checkback information CB_SIMULATE	–	–	•	Simulation of valve position active Operation using PROFINET®: CHECK_BACK Bit11 in Actuator Output Function Block
Checkback information CB_PST_RESTRICTED	–	–	•	Not possible to perform partial stroke test (PST) Operation using PROFINET®: CHECK_BACK Bit12 in Actuator Output Function Block
Checkback information CB_NOT_READY_REMOTE	–	–	•	There is no cyclic communication with the process control system. Operation using PROFINET®: CHECK_BACK Bit13 in Actuator Output Function Block
Checkback information CB_SELFTEST	–	–	•	Initialization or diagnostic function active Operation using PROFINET®: CHECK_BACK Bit15 in Actuator Output Function Block
Checkback information CB_PST_FAILED	–	–	•	Last partial stroke test (PST) failed Operation using PROFINET®: CHECK_BACK Bit22 in Actuator Output Function Block
Actuator Output Transducer Block	8.30.5	•	•	
Current operating mode (TB)	–	–	•	Current operating mode of the Actuator Transducer Block Operation using PROFINET®: TB_CURRENT_BLOCK_MODE in Actuator Output Transducer Block
Target position	–	–	•	Reading of current target position (set point) in the unit specified in the OUT_SCALE parameter Operation using PROFINET®: POSITIONING_VALUE in Actuator Output Transducer Block
Target position status	–	–	•	Status reading of the current target position (set point) Operation using PROFINET®: POSITIONING_VALUE in Actuator Output Transducer Block
Valve position	–	–	•	Reading of current valve position (actual value) in the unit specified in the OUT_SCALE parameter Operation using PROFINET®: FEEDBACK_VALUE in Actuator Output Transducer Block
Status of valve position	–	–	•	Status reading of current valve position (actual value) Operation using PROFINET®: FEEDBACK_VALUE in Actuator Output Transducer Block

Menu	Display reading	On-site: write	Integration	Adjustment range/values [default setting]/description
Self calibration	8.30.5.3	•	•	→ [No reaction], Start zero calibration, Start initialization, Stop process in progress Start self-calibration of the positioner Operation using PROFINET®: SELF_CALIB_CMD in Actuator Output Transducer Block
Self calibration status	8.30.5.4	•	•	Status reading of self calibration after the self calibration is started with SELF_CALIB_CMD Operation using PROFINET®: SELF_CALIB_STATUS in Actuator Output Transducer Block
Min. transit time CLOSE	8.30.5.5	•	•	Indicates the time required by the system (positioner, actuator and valve) to move through the rated travel/angle in the direction to close the valve (0 % position). Operation using PROFINET®: ACT_STROKE_TIME_DEC in Actuator Output Transducer Block
Min. transit time OPEN	8.30.5.6	•	•	Indicates the time required by the system (positioner, actuator and valve) to move through the rated travel/angle in the direction to open the valve (100 % position). Operation using PROFINET®: ACT_STROKE_TIME_INC in Actuator Output Transducer Block
End position mode	–	–	•	→ Torque-dependent in OPEN and CLOSE direction, [Travel-dependent in OPEN and CLOSE direction] Travel-dependent cutoff (separate for each direction of action) Operation using PROFINET®: SETP_CUTOFF_MODE in Actuator Output Transducer Block
Maximum transit time	–	–	•	Indicates the transit time limitation determined during initialization. Operation using PROFINET®: ACT_TRAV_TIME in Actuator Output Transducer Block
Lower x-range value	8.30.5.15	•	•	→ [0.0] to 99.0 % Lower range value for travel/angle in nominal or operating range Operation using PROFINET®: TRAVEL_LIM_LOW in Actuator Output Transducer Block
Upper x-range value	8.30.5.16	•	•	→ 1.0 to [100.0 %] Upper range value for travel/angle in nominal or operating range Operation using PROFINET®: TRAVEL_LIM_UP in Actuator Output Transducer Block

Appendix A (configuration instructions)

Menu	Display reading	On-site: write	Integration	Adjustment range/values [default setting]/description
Transit time OPEN	8.30.5.17	•	•	<p>→ [0.0] to 10000 s</p> <p>Required transit time required to travel through the working range towards the 100 % position.</p> <p>Operation using PROFINET®: TRAVEL_RATE_INC in Actuator Output Transducer Block</p>
Transit time CLOSE	8.30.5.18	•	•	<p>→ [0.0] to 10000 s</p> <p>Required transit time required to travel through the working range towards the 0 % position.</p> <p>Operation using PROFINET®: TRAVEL_RATE_DEC in Actuator Output Transducer Block</p>
End position w <= (set point cutoff decrease)	8.30.5.19	•	•	<p>→ 0.0 to 49.0 %, [1.0 %]</p> <p>Lower end position [%]</p> <p>If the set point falls below the entered value, the valve is moved towards the end position (corresponding to 0 % of the set point). To do so, the electropneumatic actuator is either completely filled with air or completely vented depending on the fail-safe action.</p> <p>Operation using PROFINET®: SETUP_CUTOFF_DEC in Actuator Output Transducer Block</p>
End position w >= (set point cutoff increase)	8.30.5.20	•	•	<p>→ 50.0 to 100.0 %, [99.0 %]</p> <p>Upper end position in %</p> <p>If the set point exceeds the entered value, the valve is moved towards the end position (corresponding to 100 % of the set point). To do so, the electropneumatic actuator is either completely filled with air or completely vented depending on the fail-safe action.</p> <p>Operation using PROFINET®: SETUP_CUTOFF_INC in Actuator Output Transducer Block</p>
Fail-safe position	8.30.5.22	•	•	<p>→ [Not pre-assigned], Open, Close, Current position</p> <p>Fail-safe action of the actuator mounted on the valve upon supply air failure</p> <p>Operation using PROFINET®: ACTUATOR_ACTION in Actuator Output Transducer Block</p>
Valve type	–	–	•	<p>Description of the valve</p> <p>→ Linear moving valve, Sliding valve, Rotary moving valve, Part-turn, Rotary slide valve, Multi-turn [Undefined]</p> <p>Operation using PROFINET®: VALVE_TYPE in Actuator Output Transducer Block</p>
Total valve travel limit	8.30.5.25	•	•	<p>→ 1 to 90000 * 1000, [1000 * 1000]</p> <p>Total valve travel limit</p> <p>The 'Total valve travel' status message is generated when the total valve travel exceeds the limit.</p> <p>Operation using PROFINET®: TOTAL_VALVE_TRAVEL_LIM in Actuator Output Transducer Block</p>

Menu	Display reading	On-site: write	Integration	Adjustment range/values [default setting]/description
Total valve travel	8.30.5.26	•	•	Reading of the sum of full valve travel cycles performed Operation using PROFINET®: TOTAL_VALVE_TRAVEL in Actuator Output Transducer Block
PROFINET® communication	8.31	•	•	
MAC address	8.31.2	•	•	Operation using PROFINET®: MAC_ADDRESS in Physical Block
IPv4 address	8.31.9	•	•	➔ 0.0.0.0 to 255.255.255.255 Internet protocol address assigned to the positioner for supporting TCP/IP. Operation using PROFINET®: IPv4_ADDRESS in Physical Block
IPv4 subnet mask	8.31.6	•	•	➔ 0.0.0.0 to 255.255.255.255 The subnet mask is used to separate the bits of the network ID from the bits of the host ID. Operation using PROFINET®: IPv4_SUBNET_MASK in Physical Block
IPv4 default gateway	–	•	•	➔ 0.0.0.0 to 255.255.255.255 The subnet mask is used to separate the bits of the network ID from the bits of the host ID. Operation using PROFINET®: IPv4_DEFAULT_GATEWAY in Physical Block
PROFINET® device name	–	•	•	Operation using PROFINET®: NAME_OF_STATE in Physical Block
Link State	–	•	•	– LS_UNKNOWN – LS_DOWN – LS_AUTO_NEGOTIATION_RUNNING – LS_1000MBIT_FULL_DUPLEX – LS_100MBIT_FULL_DUPLEX – LS_1000MBIT_HALF_DUPLEX – LS_10MBIT_FULL_DUPLEX – LS_1000MBIT_HALF_DUPLEX
Set point of OUT Function Block	–	•		Reading of the output value in % Output value calculated by the Analog Actuator Function Block from the SETPOINT for the Transducer Block
Security	8.40	•	•	
Unlock on-site operation	8.40.3	•	•	Indicates whether the on-site operation is enabled.
Write protection	8.40.5	•	•	Indicates whether write protection is activated.
Activate password		•	•	Indicates whether the parameterization is password-protected.

Appendix A (configuration instructions)

Menu	Display reading	On-site: write	Integration	Adjustment range/values [default setting]/description
Change password		•	•	→ 0000 to 9999

- 1) Different designations used in the SAMSON TROVIS-VIEW software and DD/DTM/EDD.
- 2) The scaling (PV_SCALE/OUT_SCALE) is used in the positioner to assign a physical unit to the set point communicated by the control system and to adapt it to the range of values. The valve position, which is communicated in the READBACK parameter, also follows this scaling.

16.1.1 Readable process data

Menu	Display reading	On-site: write	Diagnostics	Adjustment range/values [default setting]/description
Process data	10	•	•	
Valve position	10.1	•	•	Reading of valve position in %
Discrete valve position	10.2	•	•	Reading of the discrete valve position (set point when the positioner has not yet been initialized) Operation using PROFINET®: POS_D Value in Actuator Output Function Block
Status of discrete valve position	–	–	•	Status reading of the discrete valve position Operation using PROFINET®: POS_D Status in Actuator Output Function Block
Set point	10.10	•	•	Indicates the required valve position within the nominal range in automatic mode (parameter setting over PROFINET® operation) Operation using PROFINET®: SP Value in Actuator Output Function Block
Manual set point (MAN)	10.11	•	•	Reading of set point for manual mode (MAN) in %
Set point after filter	10.13	•	•	Reading of adjusted set point after set point processing (split range, tight-closing function etc.)
Fixed value over binary input	10.16	–	•	Note: firmware version 2.00.xx does not analyze this parameter.
Fixed value over binary input	10.17	•	•	Note: firmware version 2.00.xx does not analyze this parameter.
Set point status	10.20	•	•	Status reading of set point Operation using PROFINET®: SP Value in Actuator Output Function Block
Output value of AO Block	10.25	•	•	Indicates output value of the Actuator Output Function Block Operation using PROFINET®: OUT Value in Actuator Output Function Block

Menu	Display reading	On-site: write	Diagnostics	Adjustment range/values [default setting]/description
Output value status of AO Block	10.26	•	•	Indicates output value status of the Actuator Output Function Block Operation using PROFINET®: OUT Status in Actuator Output Function Block
Valve position	–	–	•	Reading of current valve position (actual value) in the unit specified in the OUT_SCALE parameter Operation using PROFINET®: FEEDBACK_VALUE in Actuator Output Transducer Block
Status of valve position	–	–	•	Status reading of current valve position (actual value) Operation using PROFINET®: FEEDBACK_VALUE in Actuator Output Transducer Block
Actual value	10.28	•	•	Actual value reading Operation using PROFINET®: READBACK Value in Actuator Output Function Block
Status of actual value	10.29	•	•	Status reading of actual value Operation using PROFINET®: READBACK Status in Actuator Output Function Block
Set point deviation	10.30	•	•	Reading of set point deviation in %
Current operating mode	10.35	•	•	Indicates current operating mode
Reason for fail-safe position	10.38	•	•	Reason why the positioner has moved to the fail-safe position.
OUTPUT 138: pressure	10.45	•	•	Pressure reading in bar at the positioner's output 138
OUTPUT 238: pressure	10.46	•	•	Pressure reading in bar at the positioner's output 238
Supply pressure	10.47	•	•	Reading of supply pressure in bar at the input (supply 9)
Temperature inside device	10.55	•	•	Reading of the temperature inside device in °C
Checkback information CB_FAIL_SAFE	–	–	•	Fail-safe position: The fail-safe position has been triggered. Possible causes: – The SAFE mode has been selected. – Active failure behavior after communication failure – Active failure behavior after a set point (SP) with BAD status Operation using PROFINET®: CHECK_BACK Bit0 in Actuator Output Function Block
Checkback information CB_REQ_LOC_OP	–	–	•	Target operating mode MAN or SAFE Operation using PROFINET®: CHECK_BACK Bit1 in Actuator Output Function Block

Appendix A (configuration instructions)

Menu	Display reading	On-site: write	Diagnostics	Adjustment range/values [default setting]/description
Checkback information CB_LOCAL_OP	–	–	•	Current operating mode MAN or SAFE Operation using PROFINET®: CHECK_BACK Bit2 in Actuator Output Function Block
Checkback information CB_DISC_DIR	–	–	•	An offset exists. Operation using PROFINET®: CHECK_BACK Bit4 in Actuator Output Function Block
Checkback information CB_SIMULATE	–	–	•	Simulation of valve position active Operation using PROFINET®: CHECK_BACK Bit1 in Actuator Output Function Block
Checkback information CB_PST_RESTRICTED	–	–	•	Not possible to perform partial stroke test (PST) Operation using PROFINET®: CHECK_BACK Bit12 in Actuator Output Function Block
Checkback information CB_NOT_READY_REMOTE	–	–	•	There is no cyclic communication with a process control system. Operation using PROFINET®: CHECK_BACK Bit13 in Actuator Output Function Block
Checkback information CB_SELFTEST	–	–	•	Initialization or diagnostic function active Operation using PROFINET®: CHECK_BACK Bit15 in Actuator Output Function Block
Checkback information CB_PST_FAILED	–	–	•	Last partial stroke test (PST) failed Operation using PROFINET®: CHECK_BACK Bit22 in Actuator Output Function Block

16.1.2 Diagnosis/maintenance

Menu	Display reading	On-site: write	Diagnostics	Adjustment range/values [default setting]/description
Status classification	–	–	•	See the 'Malfunction' chapter for details.
Condensed state	–	–	•	[Highest classification]
Start-up	–	–	•	[Highest classification]
Initialization	–	–	•	[Highest classification]
Init: incorrect operating mode	–	–	•	[No message]
Init: travel too small	–	–	•	[Maintenance required]
Init: rated travel not achieved	–	–	•	[Maintenance required]
Init: no movement	–	–	•	[Maintenance required]
Init: pin position	–	–	•	[Maintenance required]
Init: canceled (control accuracy)	–	–	•	[Highest classification]
Init: low control accuracy	–	–	•	[Highest classification]
Init: positioner not initialized	–	–	•	[Out of specification]
Init: canceled externally	–	–	•	[Maintenance required]
Init: angle limitation	–	–	•	[Highest classification]
Init: timeout	–	–	•	[Highest classification]
Zero calibration error	–	–	•	[Highest classification]
Timeout for detection of zero	–	–	•	[Maintenance required]
Zero calibration: shift >>	–	–	•	[Maintenance required]
Cyclic communication not active	–	–	•	[No message]
Configuration	–	–	•	[Highest classification]
P3799: combination invalid	–	–	•	[Failure]
No pneumatic module	–	–	•	[Failure]
Pressure sensors failed	–	–	•	[Maintenance required]

→ No message, Maintenance required, Out of specification, Function check, Failure, Highest classification
 Details on status classification:
 ► EB 8389-4

Appendix A (configuration instructions)

Menu	Display reading	On-site: write	Diagnostics	Adjustment range/values [default setting]/description
Z3799: combination invalid	–	–	•	[Maintenance required]
Forced venting switch incorrect	–	–	•	[Failure]
Process data	–	–	•	[Highest classification]
Operating mode not AUTO	–	–	•	[No message]
Fail-safe function active	–	–	•	[Highest classification]
Test in progress	–	–	•	[Function check]
Emergency mode active	–	–	•	[Maintenance required]
Fail-in-place module	–	–	•	[No message]
Control valve diagnosis	–	–	•	[Highest classification]
No supply pressure	–	–	•	[Out of specification]
Low supply pressure	–	–	•	[Maintenance required]
Supply pressure > 10 bar	–	–	•	[Out of specification]
Friction change (open pos.)	–	–	•	[No message]
Friction change (mid-pos.)	–	–	•	[No message]
Friction change (closed pos.)	–	–	•	[No message]
PST	–	–	•	[Highest classification]
PST: cancellation criteria met	–	–	•	[Maintenance required]
PST: start criteria not met	–	–	•	[No message]
FST	–	–	•	[Highest classification]
FST: cancellation criteria met	–	–	•	[Maintenance required]
FST: start criteria not met	–	–	•	[No message]
Pneumatic module A (P3799 A)	–	–	•	[Highest classification]
P3799: failure	–	–	•	[Highest classification]

→ No message, Maintenance required, Out of specification, Function check, Failure, Highest classification

Details on status classification:
▶ EB 8389-4

Menu	Display reading	On-site: write	Diagnostics	Adjustment range/values [default setting]/description
P3799: movement impaired	–	–	•	[Highest classification]
P3799: maintenance required	–	–	•	[Highest classification]
P3799: initialization error	–	–	•	[Highest classification]
Pneumatic module B (P3799 B)	–	–	•	[Highest classification]
P3799: failure	–	–	•	[Highest classification]
P3799: movement impaired	–	–	•	[Highest classification]
P3799: maintenance required	–	–	•	[Highest classification]
P3799: initialization error	–	–	•	[Highest classification]
AMR signal outside range	–	–	•	[Maintenance required]
Hardware fault	–	–	•	[Highest classification]
Limit for total valve travel exceeded	–	–	•	[Maintenance required]
Lower end position shifted	–	–	•	[Maintenance required]
Upper end position shifted	–	–	•	[Maintenance required]
Dynamic stress factor exceeded	–	–	•	[Maintenance required]
Set point deviation	–	–	•	[Maintenance required]
Angle limitation	–	–	•	[Highest classification]
Temperature inside device below min. limit	–	–	•	[Out of specification]
Temperature inside device above max. limit	–	–	•	[Out of specification]
Logging suspended	–	–	•	[Maintenance required]
Operating range in CLOSED position	–	–	•	[No message]
Operating range in max. OPEN position	–	–	•	[No message]

➔ No message, Maintenance required, Out of specification, Function check, Failure, Highest classification

Details on status classification:
▶ EB 8389-4

Appendix A (configuration instructions)

Menu	Display reading	On-site: write	Diagnostics	Adjustment range/values [default setting]/description
Operating range shifting towards CLOSED position	–	–	•	[No message]
Operating range shifting towards max. OPEN position	–	–	•	[No message]
Limited working range: lower range	–	–	•	[No message]
Limited working range: upper range	–	–	•	[No message]
Fail-in-place module	–	–	•	[Failure]
Device state	12.3	•	•	
Status messages	12.3.2	•	•	Messages which may be displayed: see Chapter 16.1.3
Logging	–	–	•	
OUTPUT 138: pressure	12.3.16	•	•	Pressure reading in bar at the positioner's output 138
OUTPUT 238: pressure	12.3.17	•	•	Pressure reading in bar at the positioner's output 238
Supply pressure	12.3.18	•	•	Reading of supply pressure in bar at the input (supply 9)
Min. supply pressure	–	–	•	Reading of the lowest measured supply pressure
Time stamp of min. supply pressure	–	–	•	Time when the lowest measured supply pressure occurred.
Max. supply pressure	–	–	•	Reading of the highest measured supply pressure
Time stamp of max. supply pressure	–	–	•	Time when the highest measured supply pressure occurred.
Dynamic stress factor	–	–	•	Indicates the stress of the bellows and/or packing.
Total valve travel	12.3.40	•	•	Totaled full valve travel cycle
Resets logging	–	–	•	Reset logging
Operating hours counter	12.3.60	•	•	Reading in d:hh:mm:ss
Temperature				
Temperature inside device	–	–	•	Reading of the temperature inside the positioner
Max. temperature inside device	12.3.50	•		Reading in °C For error monitoring after the temperature exceeds the permissible ambient temperatures. Note: This parameter can be found in the [Temperature] folder in the 'Diagnosis' user level.

→ No message, Maintenance required, Out of specification, Function check, Failure, Highest classification

Details on status classification:
▶ EB 8389-4

Menu	Display reading	On-site: write	Diagnostics	Adjustment range/values [default setting]/description
Min. temperature inside device	12.3.52	•		Reading in °C For error monitoring after the temperature falls below the permissible ambient temperatures. Note: This parameter can be found in the [Temperature] folder in the 'Diagnosis' user level.
Min. temperature limit	–	–	•	Enter the temperature limit for the 'Min. temperature limit' status message. Note: This parameter can be found in the [Temperature] folder.
Max. temperature limit	–	–	•	Enter the temperature limit for the 'Max. temperature limit' status message. Note: This parameter can be found in the [Temperature] folder.
Device switched on since initialization	–	–	•	Indicates how long the positioner has been switched on since the last initialization.
Device in closed-loop operation	–	–	•	Indicates how long the positioner has been in closed-loop operation.
Device in closed-loop operation since last initialization	–	–	•	Indicates how long the positioner has been in closed-loop operation since the last initialization.
Device in MAN mode	–	–	•	Indicates how long the positioner has been in MAN mode.
Number of initializations	12.3.65	•	•	Number of successfully completed valve initializations
Number of zero calibrations	12.3.66	•	•	Number of performed zero calibrations
Statistical information	12.5	•	•	
Histograms				
Reset histograms	–	–	•	→ Confirm to reset all histograms.
Valve position	–	–	•	→ Open folder to view the histogram. Details in the Operating Instructions for valve diagnostics ► EB 8389-4
Set point deviation	–	–	•	→ Open folder to view the histogram. Details in the Operating Instructions for valve diagnostics ► EB 8389-4
Load cycle	–	–	•	→ Open folder to view the histogram. Details in the Operating Instructions for valve diagnostics ► EB 8389-4
Course of end position	–	–	•	
Threshold for end position shift	–	–	•	Enter the limit by how much the lower end position must change to generate the 'Course of lower end position' and 'Course of upper end position' status messages.
Course of lower end position	–	–	•	

Appendix A (configuration instructions)

Menu	Display reading	On-site: write	Diagnostics	Adjustment range/values [default setting]/description
Time stamp	–	–	•	Time reading when the course of lower end position was recorded.
Temperature	–	–	•	Reading of the temperature inside the positioner while the course of lower end position was being recorded.
Course of upper end position	–	–	•	
Time stamp	–	–	•	Time reading when the course of upper end position was recorded.
Temperature	–	–	•	Reading of the temperature inside the positioner while the course of upper end position was being recorded.
Course of supply pressure	–	–	•	Note: Data are only shown for positioners with pressure sensors.
New recording threshold for supply pressure	–	–	•	Enter the limit by how much the supply pressure must change to start recording the course of the supply pressure.
Time stamp	–	–	•	Time reading when the course of supply pressure was recorded.
Supply pressure during last initialization	–	–	•	Reading of the supply pressure recorded during the last initialization
Reset course of supply pressure	–	–	•	→ Confirm to reset the course of supply pressure.
Valve signature	12.5.6	•	•	Note: Only positioners with pressure sensors
Start recording of reference graphs	12.5.6.1	•	•	→ Confirm to start recording of reference graphs.
Stop test	–	•	•	→ Confirm to stop recording of reference graphs.
Valve signature status	–	–	•	Indicates whether the valve signature is valid or not.
Monitoring	–	–	•	→ Open folder to view the graph. Details in the Operating Instructions for valve diagnostics ► EB 8389-4
Friction	–	–	•	→ Open folder to view the graph. Details in the Operating Instructions for valve diagnostics ► EB 8389-4
Result of last valve signature	12.5.6.4	•	•	→ Confirm to read the status of the last valve signature.
Time stamp	–	–	•	Time reading when the reference was recorded.
Detected lower bench range value	–	–	•	Reading of the signal pressure p_{out} at minimum supply
Detected upper bench range value	–	–	•	Reading of the signal pressure p_{out} at maximum supply

Menu	Display reading	On-site: write	Diagnostics	Adjustment range/values [default setting]/description
Min. hysteresis	–	–	•	Reading of the lowest possible hysteresis (minimum signal pressure difference in relation to the bench range)
Max. hysteresis	–	–	•	Reading of the highest possible hysteresis (maximum signal pressure difference in relation to the bench range)
Average hysteresis	–	–	•	Reading of the average hysteresis (average signal pressure difference in relation to the bench range)
Reset monitoring values	–	–	•	→ Confirm to reset the monitoring values.
Test functions	12.8	•	•	
Partial stroke test (PST)	12.8.1	•	•	
Start PST	12.8.1.1	•	•	→ Confirm to start the test.
Stop test	–	•	•	→ Confirm to stop the test.
Time until next test	–	–	•	Indicates how long until the next time-controlled PST starts.
Result or Result of last test ¹⁾	12.8.1.5	•	•	→ Confirm to read the status of the last partial stroke test (PST).
Test status	12.8.1.6	•	•	Indicates whether the test is active or inactive.
Number of successful tests	–	–	•	Indicates the number of successfully performed tests since the last test reset.
Number of canceled tests	–	–	•	Indicates the number of canceled tests since the last test reset.
Number of failed start criteria	–	–	•	Indicates the number of failed start criteria. The start criteria are determined in the [Configuration] folder.
Canceled: x monitoring	12.8.1.10	•	•	Reading in %. Canceled when range is violated. Note: this parameter can be found in the [Configuration] folder in the 'Diagnosis' user level.
Configuration	–	–	•	Details in the Operating Instructions for valve diagnostics ▶ EB 8389-4
Reports and graphs	–	–	•	Details in the Operating Instructions for valve diagnostics ▶ EB 8389-4
Full stroke test (FST)	12.8.2			
Start FST	12.8.2.1	•	•	→ Confirm to start the test.
Stop test	–	•	•	→ Confirm to stop the test.
Result or Result of last test ¹⁾	12.8.2.5	•	•	→ Confirm to read the status of the last full stroke test (FST).
Test status	12.8.2.6	•	•	Indicates whether the test is active or inactive.

Appendix A (configuration instructions)

Menu	Display reading	On-site: write	Diagnostics	Adjustment range/values [default setting]/description
Number of successful tests	–	–	•	Indicates the number of successfully performed tests since the last test reset.
Number of canceled tests	–	–	•	Indicates the number of canceled tests since the last test reset.
Number of failed test criteria	–	–	•	Indicates the number of failed start criteria. The start criteria are determined in the [Configuration] folder.
Configuration	–	–	•	Details in the Operating Instructions for valve diagnostics ▶ EB 8389-4
Reports and graphs	–	–	•	Details in the Operating Instructions for valve diagnostics ▶ EB 8389-4
Dead band	12.8.3			
Start dead band test	12.8.3.1	•	•	➔ Confirm to start the test.
Stop test	–	•	•	➔ Confirm to stop the test.
Result or Result of last test ¹⁾	12.8.3.5	•	•	➔ Confirm to read the status of the last dead band test.
Test status	–	•	•	Indicates whether the test is active or inactive.
Configuration	–	–	•	Details in the Operating Instructions for valve diagnostics ▶ EB 8389-4
Reports and graphs	–	–	•	Details in the Operating Instructions for valve diagnostics ▶ EB 8389-4
Valve signature	12.8.4			Note: Only positioners with pressure sensors
Start repetition test	12.8.4.1	•	•	➔ Confirm to start the test.
Stop test	–	•	•	➔ Confirm to stop the test.
Result or Result of last valve signature ¹⁾	12.8.4.5	•	•	➔ Confirm to read the status of the repetition test (valve signature).
Valve signature status	–	–	•	Indicates whether the valve signature is valid or not.
Reports and graphs	–	–	•	Details in the Operating Instructions for valve diagnostics ▶ EB 8389-4

¹⁾ Different designations used in the SAMSON TROVIS-VIEW software and DD/DTM/EDD.

16.1.3 Diagnosis: status messages

Active status messages are also shown in the main display (display/numbering: 0.50).

Menu	Display reading	On-site: write	Diagnostics	Adjustment range/values [default setting]/description
Diagnosis/maintenance	10	•	•	
Device state	10.1	•	•	
Status messages	10.1.1	•	•	
Condensed state	10.1.1.1	•	•	Status indicators
Start-up	10.1.1.2	–	•	Status indicators
Initialization error	10.1.1.3	• ¹⁾	•	Status indicators
Incorrect operating mode or Init: incorrect operating mode ²⁾	10.1.1.4	• ¹⁾	•	The incorrect operating mode is set.
	10.1.1.5	• ¹⁾	–	➔ Confirm to clear message.
Travel too small or Init: travel too small ²⁾	10.1.1.6	• ¹⁾	•	The determined travel is below the limit.
	10.1.1.7	• ¹⁾	–	Confirm to clear message.
Rated travel not achieved or Init: rated travel not achieved ²⁾	10.1.1.8	• ¹⁾	•	The detected rated travel is smaller than the value in the setting.
	10.1.1.9	• ¹⁾	–	➔ Confirm to clear message.
No movement or Init: no movement ²⁾	10.1.1.10	• ¹⁾	•	Possible cause: valve blockage.
	10.1.1.11	• ¹⁾	–	➔ Confirm to clear message.
Pin position or Init: pin position ²⁾	10.1.1.12	• ¹⁾	•	The adjusted pin position does not match the rated travel.
	10.1.1.13	• ¹⁾	–	➔ Confirm to clear message.
Canceled (control accuracy) or Init: canceled (control accuracy) ²⁾	10.1.1.14	• ¹⁾	•	Control criteria are not fulfilled.
	10.1.1.15	• ¹⁾	–	➔ Confirm to clear message.
Low control accuracy or Init: low control accuracy ²⁾	10.1.1.16	• ¹⁾	•	Control criteria are not fulfilled. The positioner remains ready for use.
	10.1.1.17	• ¹⁾	–	➔ Confirm to clear message.
Positioner not initialized or Init: positioner not initialized ²⁾	10.1.1.18	• ¹⁾	•	The positioner needs to be initialized.
Initialization canceled (external) or Init: canceled externally ²⁾	10.1.1.19	• ¹⁾	•	Initialization canceled.
	10.1.1.20	• ¹⁾	–	➔ Confirm to clear message.

Appendix A (configuration instructions)

Menu	Display reading	On-site: write	Diagnostics	Adjustment range/values [default setting]/description
Angle limitation or Init: angle limitation ²⁾	10.1.1.21	• ¹⁾	•	The maximum permissible angle of rotation ($\pm 30^\circ$) has been exceeded.
	10.1.1.22	• ¹⁾	–	→ Confirm to clear message.
Timeout or Init: timeout ²⁾	10.1.1.23	• ¹⁾	•	Initialization takes too long. Possible cause: valve blockage.
	10.1.1.24	• ¹⁾	–	→ Confirm to clear message.
Zero calibration error	10.1.1.25	• ¹⁾	•	Initialization takes too long. Possible cause: valve blockage.
Timeout for detection of zero	10.1.1.26	• ¹⁾	•	Zero calibration takes too long. Possible cause: no supply pressure or actuator/plug stem blocked.
	10.1.1.27	• ¹⁾	–	→ Confirm to clear message.
Zero calibration: shift >>	10.1.1.28	• ¹⁾	•	Zero has shifted. Possible cause: wear at the seat and plug.
Configuration	10.1.1.29	• ¹⁾	•	Status indicators
No pneumatic module	10.1.1.31	• ¹⁾	•	Message when no pneumatic module has been inserted (at least one pneumatic module must be inserted).
Pressure sensor failure	10.1.1.32	• ¹⁾	•	No more communication with pressure sensors. Defective pressure sensors.
	10.1.1.33	• ¹⁾	•	→ Confirm to clear message.
Forced venting switch incorrect	10.1.1.35	• ¹⁾	•	Forced venting switch is not set correctly (see the 'Installation' chapter).
Process data	10.1.1.43	• ¹⁾	•	Status indicators
Operating mode not AUTO	10.1.1.44	• ¹⁾	•	Current operating mode is not AUTO.
Test in progress	10.1.1.46	• ¹⁾	•	A test is being performed.
Emergency mode active	10.1.1.47	• ¹⁾	•	Emergency mode is active. Possible cause: travel measurement does not function properly.
Fail-in-place module activated	10.1.1.48	• ¹⁾	•	Status indicators
Control valve diagnosis	10.1.1.49	• ¹⁾	•	Status indicators
Friction change (open pos.)	10.1.1.50	• ¹⁾	•	The friction conditions in the range of the valve's open position have changed.
Friction change (mid-position)	10.1.1.51	• ¹⁾	•	The friction conditions in the range of the valve's mid-position have changed.

Menu	Display reading	On-site: write	Diagnostics	Adjustment range/values [default setting]/description
Friction change (closed pos.)	10.1.1.52	• ¹⁾	•	The friction conditions in the range of the valve's closed position have changed.
Valve signature recording failed	10.1.1.53	• ¹⁾	•	Conditions for a completed valve signature not fulfilled.
	10.1.1.54	• ¹⁾	•	Confirm to clear message.
No supply pressure	10.1.1.55	• ¹⁾	•	No supply pressure is available.
Low supply pressure	10.1.1.56	• ¹⁾	•	Supply pressure is too low.
Supply pressure > 10 bar	10.1.1.57	• ¹⁾	•	Supply pressure is too high.
PST	10.1.1.58	• ¹⁾	•	Status indicators
PST: cancellation criteria met	10.1.1.59	• ¹⁾	•	Partial stroke test (PST) canceled.
PST: start criteria not met	10.1.1.60	• ¹⁾	•	Partial stroke test (PST) did not start.
FST	10.1.1.61	• ¹⁾	•	Status indicators
FST: cancellation criteria met	10.1.1.62	• ¹⁾	•	FST (full stroke test) canceled.
FST: start criteria not met	10.1.1.63	• ¹⁾	•	Full stroke test (FST) did not start.
Pneumatic module A (P3799 A)	10.1.1.64	• ¹⁾	•	Status indicators
P3799: failure	10.1.1.65	• ¹⁾	•	Error in pneumatic module. Replacement may be necessary.
	10.1.1.66	• ¹⁾	•	➔ Confirm to clear message.
P3799: movement impaired	10.1.1.67	• ¹⁾	•	Possible cause: no supply pressure, internal error, defect.
	10.1.1.68	• ¹⁾	•	➔ Confirm to clear message.
P3799: maintenance required	10.1.1.69	• ¹⁾	•	Possible cause: the friction conditions have changed.
	10.1.1.70	• ¹⁾	•	➔ Confirm to clear message.
P3799: initialization error	10.1.1.71	• ¹⁾	•	Conditions for initialization not fulfilled.
	10.1.1.72	• ¹⁾	•	➔ Confirm to clear message.
Pneumatic module B (P3799 B)	10.1.1.73	• ¹⁾	•	Status indicators
P3799: failure	10.1.1.74	• ¹⁾	•	Error in pneumatic module. Replacement may be necessary.
	10.1.1.75	• ¹⁾	•	➔ Confirm to clear message.

Appendix A (configuration instructions)

Menu	Display reading	On-site: write	Diagnostics	Adjustment range/values [default setting]/description
P3799: movement impaired	10.1.1.76	• ¹⁾	•	Possible cause: no supply pressure, internal error, defect.
	10.1.1.77	• ¹⁾	•	→ Confirm to clear message.
P3799: maintenance required	10.1.1.78	• ¹⁾	•	Possible cause: the friction conditions have changed.
	10.1.1.79	• ¹⁾	•	→ Confirm to clear message.
P3799: initialization error	10.1.1.80	• ¹⁾	•	Conditions for initialization not fulfilled.
	10.1.1.81	• ¹⁾	•	→ Confirm to clear message.
AMR signal outside range	10.1.1.82	• ¹⁾	•	Travel measurement is defective.
	10.1.1.83	• ¹⁾	•	→ Confirm to clear message.
Hardware fault	10.1.1.84	• ¹⁾	•	Internal device error. Initialization key (INIT) jammed. Contact SAMSON's After-sales Service.
Limit for total valve travel exceeded	10.1.1.85	• ¹⁾	•	Limit for total valve travel exceeded.
Lower end position shifted	10.1.1.86	• ¹⁾	•	Possible cause: mounting arrangement or travel linkage of positioner has slipped.
	10.1.1.87	• ¹⁾	•	→ Confirm to clear message.
Upper end position shifted	10.1.1.88	• ¹⁾	•	Possible cause: mounting arrangement or travel linkage of positioner has slipped.
	10.1.1.89	• ¹⁾	•	→ Confirm to clear message.
Dynamic stress factor exceeded or Dynamic stress factor active ²⁾	10.1.1.90	• ¹⁾	•	The limit is exceeded. It may be necessary to change the valve packing.
Set point deviation	10.1.1.91	• ¹⁾	•	Control loop error, the valve no longer follows the controlled variable within tolerable times.
Temperature inside device below min. limit	10.1.1.97	• ¹⁾	•	Warning not affecting the positioner's functioning.
Temperature inside device above max. limit	10.1.1.98	• ¹⁾	•	Warning not affecting the positioner's functioning.
Angle limitation	10.1.1.99	• ¹⁾	•	The maximum permissible angle of rotation ($\pm 30^\circ$) has been exceeded (only in open-loop control mode).
	10.1.1.100	• ¹⁾	•	→ Confirm to clear message.
Logging suspended	10.1.1.101	• ¹⁾	•	It was not possible to write all logging entries.
	10.1.1.102	• ¹⁾	•	→ Confirm to clear message.

Menu	Display reading	On-site: write	Diagnostics	Adjustment range/values [default setting]/description
Operating range in CLOSED position	10.1.1.103	• ¹⁾	•	The valve remains in the closed position. Possible cause: no supply pressure or actuator/plug stem blocked.
Operating range in max. OPEN position	10.1.1.104	• ¹⁾	•	The valve remains in the max. OPEN position. Possible cause: no supply pressure or actuator/plug stem blocked.
Operating range shifting towards CLOSED position	10.1.1.105	• ¹⁾	•	The operating range has shifted towards the CLOSED position. Possible cause: valve sized incorrectly.
Operating range shifting towards max. OPEN position	10.1.1.106	• ¹⁾	•	The operating range has shifted towards the max. OPEN position. Possible cause: valve sized incorrectly.
Limited working range: lower range	10.1.1.107	• ¹⁾	•	The valve position is restricted to the lower working range. Possible cause: no supply pressure or actuator/plug stem blocked.
Limited working range: upper range	10.1.1.108	• ¹⁾	•	The valve position is restricted to the upper working range. Possible cause: no supply pressure or actuator/plug stem blocked.
Fail-in-place module error	10.1.1.111	• ¹⁾	•	The fail-in-place module is defective.
General diagnosis	12.3.2	•	•	
Sensor element error	12.3.2.1	•	•	Sensor failure It is activated after one of the following sensors fails: pressure sensor, temperature sensor, humidity sensor, travel sensor (AMR sensor)
Actuator element error	12.3.2.2	•	•	A valve malfunction has arisen. Possible cause: actuator/plug stem blocked
Parameter setting error	12.3.2.3	•	•	It is activated if: – Impermissible combination of pneumatic modules – No pneumatic module is installed. – Invalid combination of option modules
Evaluation electronics error	12.3.2.4	•	•	Hardware fault (leads to failure of the device)
Impermissible ambient temperature	12.3.2.5	•	•	The temperature in the environment in which the positioner is installed is too high or too low.
Supply air missing	12.3.2.6	•	•	Supply air failure
Communication failed	12.3.2.7	•	•	Ethernet communication to the process control system has failed. Possible cause: the Internet connection has been interrupted.

Appendix A (configuration instructions)

Menu	Display reading	On-site: write	Diagnostics	Adjustment range/values [default setting]/description
Valve diagnostics	12.3.3	•	•	
Step response diagnosis	12.3.3.1	•	•	Partial stroke test (PST) failed
Pneumatic unit failure	12.3.3.2	•	•	The pneumatic module is not inserted correctly or is defective.
Positioner temperature out of specification	12.3.3.3	•	•	The temperature measured inside the housing is outside the permissible limits due to the ambient temperature or radiated process heat
Status message on operating mode	12.3.3.4	•	•	The incorrect operating mode is set for the action selected.
Impermissible dynamic load	12.3.3.5	•	•	The load of the bellows/packing is too high. This may be due to excessive wear of parts.
Mounting error	12.3.3.6	•	•	The positioner is mounted incorrectly.
Travel counter, total valve travel	12.3.3.7	•	•	The absolute total valve travel (totalled full valve travel cycle) has exceeded the 'Total valve travel limit' (12.1.20).
Offset	12.3.3.8	•	•	Control loop error The control valve no longer follows the controlled variable within tolerable times.
Zero and end position shift	12.3.3.9	•	•	The zero or end point has shifted due to dirt or wear on the seat and plug.
Analysis of internal signals	12.3.3.10	•	•	The functioning of the positioner is impaired by electromagnetic interference.
Supply pressure out of specification	12.3.3.11	•	•	The supply pressure is too high or too low.
Changed friction	12.3.3.12	•	•	The friction has increased. This may be due to the actuator stem's restricted ability to move.
Valve position histogram	12.3.3.13	•	•	The valve position histogram indicates that the working range has shifted. This may be due to changed process conditions or wear at the seat and plug.
Seat leakage between the seat and plug out of specification	12.3.3.14	•	•	Wear at the seat and plug cause seat leakage. Note: firmware version 1.00.xx does not analyze this parameter.
Incorrect travel measurement	12.3.3.15	•	•	The valve position cannot be reliably measured. The positioner attachment may be incorrect (incorrect lever or pin position).

¹⁾ Reading only when active

²⁾ Differed designations used in the SAMSON TROVIS-VIEW software and DD/DTM/EDD.

16.1.4 Reset functions

Menu	Display reading	On-site: write	Diagnostics	Adjustment range/values [default setting]/description
Reset functions	14	•	•	See the 'Operation' chapter for procedure to reset the positioner.
Reset diagnosis	14.1	•	•	Resets all diagnostic functions including graphs and histograms.
Reset (standard)	14.2	•	•	Resets the positioner to the state as upon delivery. Actuator and valve-specific settings remain unchanged.
Reset (advanced)	14.3	•	•	All parameters will be reset to their defaults adjusted upon delivery.
Restart	14.6	•	•	The positioner is shut down and restarted.
Reset in progress	–	•	•	Indicates whether the reset function is active or not.
Reset reports	14.10	•	–	
Delete PST reports	14.10.1	•	•	The reports and graphs of all saved partial stroke tests are deleted.
Delete FST reports	14.10.2	•	•	The reports and graphs of all saved full stroke tests are deleted.
Reset dead band data	–	–	•	The reports, measured data and graphs for the dead band test are deleted.
Reset course of end position	–	–	•	The measured data of the course of the lower and upper end positions are deleted.
Reset histograms	–	–	•	The measured data and archived data of the histograms (valve position, set point deviation and load cycle) are deleted.
Reset initialization	14.15	•	•	All parameters for the start-up settings are reset. The positioner needs to be re-initialized afterwards.
Reset logging	–	–	•	Logged events, alarms and alerts are deleted.
Reset monitoring values	–	–	•	The measured data recorded for the valve signature (statistical information) are deleted.
Reset course of supply pressure	–	–	•	The measured data for the course of the supply pressure are reset.
Reset application	–	•	•	Resets the positioner to the state as upon delivery. Actuator and valve-specific settings remain unchanged.
Reset communication	–	•	•	Reset configuration parameters for PROFINET® configuration (device name, IPv4 address and IPv4 subnet mask)

16.2 Operation using PROFINET®

16.2.1 Physical Block

Parameters	Adjustment range/values [default setting]/description
CURRENT_MODE	Current mode of the Physical Block · Read only
IM_Tag_Function	Device ID used to identify the positioner and its task/function
TARGET_MODE	Target operating mode: – Automatic – Out of service The CURRENT_MODE directly follows the TARGET_MODE. Device alarms are suppressed in the 'Out of service' mode.
OrderID	Positioner's order code · Read only
SOFTWARE_REVISION	Positioner firmware version · Read only Positioner's software ID according to NAMUR Recommendation NE 53
HARDWARE_REVISION	Positioner hardware version · Read only
DEVICE_Man_ID	Manufacturer of the positioner · Read only For SAMSON TROVIS 3797 Positioner: 0x0042
DeviceType	Device type (TROVIS 3797) · Read only
IM_Serial_Number	Serial number · Read only
DIAGNOSIS	Detailed information on the positioner (coded bitwise) · Read only More than one alarm possible at one time.
LIST_IDENT_NUM_SUP	List of ID numbers of supported devices · Read only
IM_Tag_Location	Tag location identification · Read only
IM_Revision_Counter	Configuration counter · Read only The configuration counter counts the changes to static parameters. Static parameters are parameters which are not changed by the process.
IM_Profile_ID	Profile information · Read only – TROVIS 3797 ID: 0xB310 – Profile ID: 0x9700
IM_Profile_Specific_Type	Profile-specific block type · Read only
RESET	1: Application Reset: resets the positioner to the state as upon delivery. Actuator and valve-specific settings remain unchanged. 2: Positioner rebooted 2712: Communication reset: device name, IPv4 address and IPv4 subnet mask
IM_Descriptor	Description (user-defined text)
LANGUAGE	Language of text on positioner display · Read only
IM_Date	Date of installation · Read only
STARTUP_PARAM_VALIDITY	Validity of start-up settings 0: Start-up parameters are not accepted 1: Units only 2: Profile start-up parameters and manufacturer-specific start-up parameters are accepted

Parameters	Adjustment range/values [default setting]/description
IPv4_ADDRESS	IPv4 address Internet protocol address assigned to the positioner for supporting TCP/IP.
IPv4_SUBNET_MASK	IPv4 subnet mask The subnet mask is used to separate the bits of the network ID from the bits of the host ID.
IPv4_DEFAULT_GATEWAY	IPv4 default gateway The default gateway serves as the node in a PROFINET network. It is assumed that it knows how to forward packages onto other networks. It is the default route setting (assigned to the default gateway) for determining where packages are to be sent for any IP addresses without a defined specific route.
NAME_OF_STATION	PROFINET device name
MAC_ADDRESS	MAC address
WRITE_PROTECTION	Write protection active/not active
ALARM_DELAY	Alarm delay [s] Filter for brief alarm events An alarm event must be active for at least the time defined in ALARM_DELAY to generate a diagnostic event. ALARM_DELAY is not taken into account for the following events: – DIA_COLDSTART – DIA_WARMSTART – DIA_UPDATE_EVENT – EXTENSION_AVAILABLE
UPDATE_EVENT_ACK	Confirm parameter changes 0: Parameter changes are automatically adopted (no manual confirmation necessary) 1: Parameter changes must be manually confirmed to adopt them.
UPDATE_EVENT_MODE	Type of confirmation upon parameter changes Includes the configuration for the action of the update event flag in all status bytes that have values with cyclic (Cyc) attributes. They are made available to the host by the device.
NE107_COMMON	General diagnosis Common device diagnosis (coded bitwise) The control valve diagnosis is contained in the NE107_ACT_EL_PNEU parameter.
LINK_NE107_COMMON	Assign general diagnosis status Define the reaction of the control valve to valve-specific diagnostic events.
LATEST_CHANGE	Time of the last change to a static parameter · Read only
NE107_STATUS	Condensed state of the positioner · Read only 0: OK 1: Maintenance required/maintenance demanded 2: Out of specification 3: Function check 4: Failure
STARTUP_RECORD	Start-up parameters

16.2.2 Actuator Output Function Block

Parameters	Adjustment range/values [default setting]/description
CURRENT_MODE	Current mode of the Actuator Output Function Block · Read only
IM_Tag_Function	Tag number used to identify the control valve and its task/function
TARGET_MODE	Target operating mode: – Automatic – Manual – Out of service The CURRENT_MODE directly follows the TARGET_MODE. Device alarms are suppressed in the 'Out of service' mode.
SP	Set point [unit of PV_SCALE] Required valve position within the nominal range in automatic mode
PV_SCALE	Set point range defined by: – Upper range value – Lower range value – Unit – Decimal places
READBACK	Actual value · Read only Valve position based on the set point range defined in PV_SCALE
FSAFE_TIME	Delay time [s] Time that it takes from detection of an error of the set point valid in the current operating mode until the failure behavior is triggered: the failure behavior (FSAFE_TYPE) is triggered after the failure behavior delay (FSAFE_TIME) has elapsed and the error still exists.
FSAFE_TYPE	Failure behavior Reaction to a detected error of the set point valid in the current operating mode after the failure behavior delay (FSAFE_TIME) has elapsed 0: Control to the FSAFE_VALUE value (OUT parameter is set to UNCERTAIN) 1: Control to the last valid set point (OUT parameter is set to UNCERTAIN) 2: The actuator moves to the fail-safe position defined in the ACTOR_ACTION parameter (see Actuator Transducer Block) (OUT parameter is set to BAD)
FSAFE_VALUE	Set point for failure behavior when the setting FSAFE_TYPE = 0
POS_D	Discrete valve position · Read only 0: Not initialized 1: Closed 2: Open 3: Intermediate position
SETP_DEVIATION	Set point deviation [%] · Read only Set point – Actual value
CHECK_BACK	Checkback information Detailed information on the positioner (coded bitwise) More that one alarms may exist.

Parameters	Adjustment range/values [default setting]/description
CHECK_BACK_MASK	Supported checkback information Definition of supported information bits for checkback information (CHECK_BACK) 0: Not supported 1: Supported
INCREASE_CLOSE	Determines the direction of action, i.e. how the set point is assigned to the controlled variable – Increasing/increasing – Increasing/decreasing
OUT	Output value in [mm], [degrees] or [%] · Read only Output value calculated by the Analog Actuator Function Block from the SETPOINT for the Transducer Block
OUT_SCALE	Travel/angle range defined by: – Upper range value – Lower range value – Unit – Decimal places A non-linear characteristic is adapted to the reduced travel. Maximum value for upper value = rated travel
READBACK_UNITS	Unit of the actual value (READBACK)
TARGET_MODE	Target operating mode – Automatic – Manual – Out of service
LOCAL_OP_ENA	Unlock on-site operation 0: On-site operation locked 1: On-site operation enabled On-site operation is automatically enabled upon communication failure lasting longer than 30 seconds.
SIMULATE_ENABLE	Enable simulation 0: Simulation deactivated 1: Simulation activated
SIMULATE_VALUE	Simulation value for actual valve position (READBACK) · Read only
SIMULATE_STATUS	Simulated status for actual valve position (READBACK) · Read only
PROCESS_VARIABLE	Coding for the actual value
STARTUP_RECORD	Start-up parameters – FSAFE_TIME – FSAFE_TYPE – FSAFE_VALUE

16.2.3 Actuator Transducer Block

Parameters	Adjustment range/values [default setting]/description
CURRENT_MODE	Current operating mode of the Actuator Transducer Block · Read only
ACTUATOR_ACTION	Fail-safe action of the actuator mounted on the valve upon supply air failure: 0: Not initialized 1: Open (100 %) 2: Close (0 %)
ACTUATOR_TYPE	Type of actuator mounted on the valve: 0: Electropneumatic 1: Electric 2: Electrohydraulic 3: Other
ACT_STROKE_TIME_DEC	Min. transit time CLOSE [s] · Read only Indicates the time required by the system (positioner, actuator and valve) to move through the rated travel/angle in the direction to close the valve (0 % position) (measured during initialization).
ACT_STROKE_TIME_INC	Min. transit time OPEN [s] · Read only Indicates the time required by the system (positioner, actuator and valve) to move through the rated travel/angle in the direction to open the valve (100 % position) (measured during initialization).
ACT_TRAV_TIME	Maximum transit time [s] · Read only The transit time limit is determined by the positioner during initialization.
DEADBAND	Dead band (integral-action component)
FEEDBACK_VALUE	Current valve position (actual value) in the unit specified in the OUT_SCALE parameter · Read only
POSITIONING_VALUE	Current target position (set point) in the unit specified in the OUT_SCALE parameter · Read only
SELF_CALIB_CMD	Start self-calibration of the positioner
SELF_CALIB_STATUS	Status of self-calibration after the self-calibration is started with SELF_CALIB_CMD · Read only
SETP_CUTOFF_DEC	Lower end position [%] If the set point falls below the entered value, the valve is moved towards the end position (corresponding to 0 % of the set point). To do so, the electropneumatic actuator is either completely filled with air or completely vented depending on the fail-safe action.
SETP_CUTOFF_INC	Upper end position [%] If the set point exceeds the entered value, the valve is moved towards the end position (corresponding to 100 % of the set point). To do so, the electropneumatic actuator is either completely filled with air or completely vented depending on the fail-safe action.
SETP_CUTOFF_MODE	End position mode Travel-dependent cutoff (separate for each direction of action) 0: Torque-dependent in OPEN and CLOSE direction 3: Travel-dependent in OPEN and CLOSE direction

Parameters	Adjustment range/values [default setting]/description
TOTAL_VALVE_TRAVEL	Totaled full valve travel cycle · Read only
TOTAL_VALVE_TRAVEL_LIM	Total valve travel limit The 'Total valve travel' status message is generated when the total valve travel exceeds the limit.
TRAVEL_LIM_LOW	Lower x-range value [%] Lower range value for travel/angle in nominal or operating range The nominal/operating range is set in the OUT_SCALE parameter.
TRAVEL_LIM_UP	Upper x-range value [%] Upper range value for travel/angle in nominal or operating range The nominal/operating range is set in the OUT_SCALE parameter.
TRAVEL_RATE_DEC	Transit time CLOSE [s] Required transit time required to travel through the working range towards the 0 % position.
TRAVEL_RATE_INC	Transit time OPEN [s] Required transit time required to travel through the working range towards the 100 % position.
VALVE_TYPE	Valve type: 0: Linear moving valve, sliding valve 1: Rotary moving valve, part-turn 2: Rotary moving valve, multi-turn
NE107_ACT_EL_PNEU	Detailed diagnosis information on the actuator · Read only
LINK_NE107_ACT_EL_PNEU	Status assignment of valve/actuator diagnosis · Read only

16.3 Valve characteristic selection

The characteristics that can be selected in menu item **8.1.9** are shown in the following in graph form.

i Note

A characteristic can only be defined (user-defined characteristic) using an operating software (e.g. SAMSON's TROVIS-VIEW or DD/DTM/EDD).

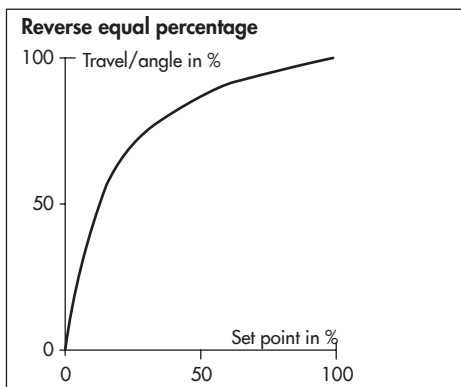
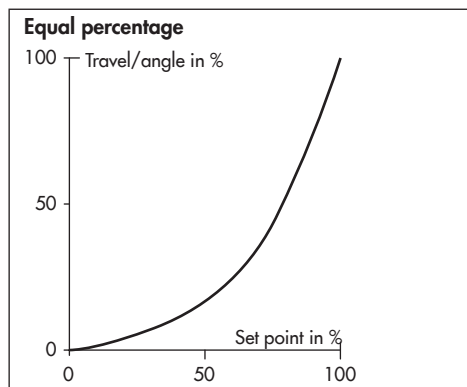
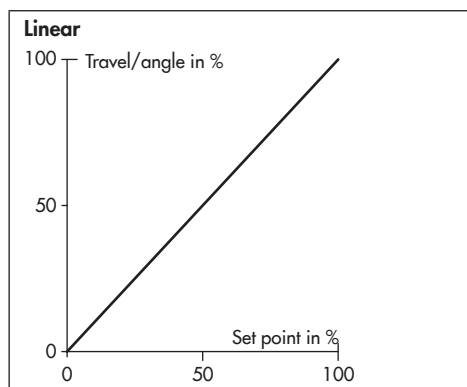

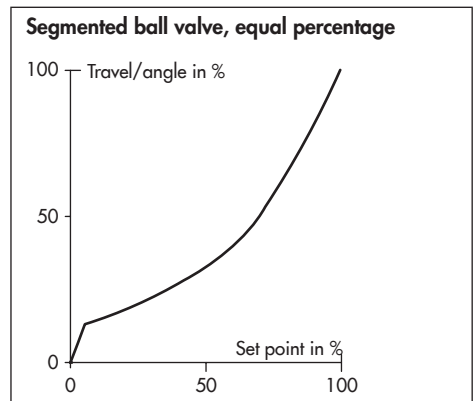
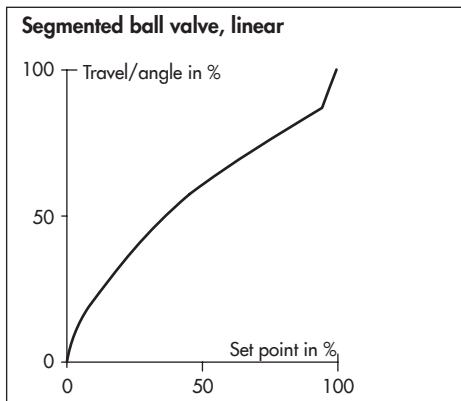
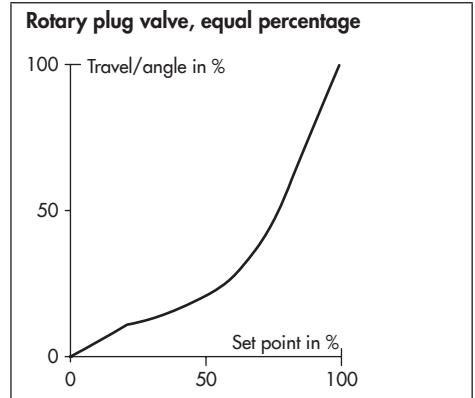
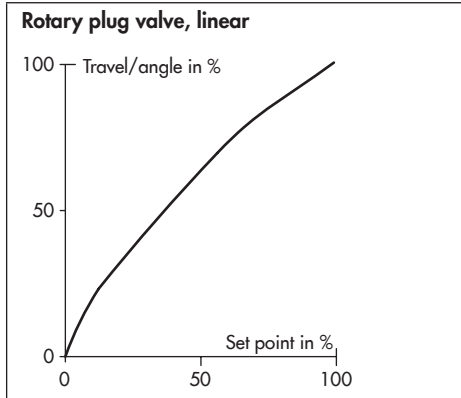
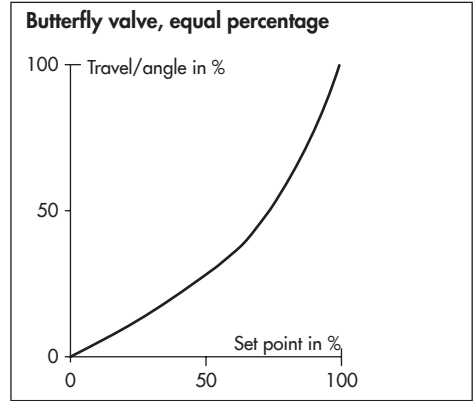
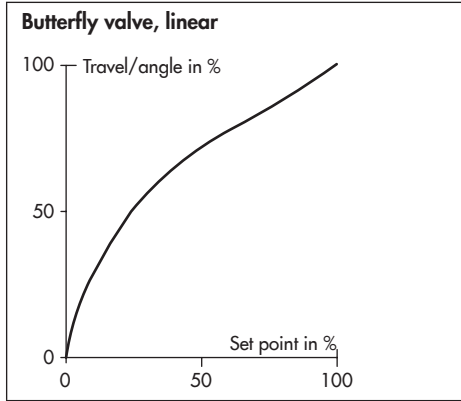

17 Appendix B

17.1 After-sales service

Contact our after-sales service for support concerning service or repair work or when malfunctions or defects arise.

You can reach our after-sales service at aftersalesservice@samsongroup.com.

Addresses of SAMSON AG and its subsidiaries

The addresses of SAMSON AG, its subsidiaries, representatives and service facilities worldwide can be found on our website (www.samsongroup.com) or in all SAMSON product catalogs.

Required specifications

Please submit the following details:

- Order number and position number in the order
- Model number, material number, serial number, firmware version (see the 'Markings on the device' chapter for name-plate details)

EB 8497 EN



SAMSON AKTIENGESELLSCHAFT
Weismüllerstraße 3 · 60314 Frankfurt am Main, Germany
Phone: +49 69 4009-0 · Fax: +49 69 4009-1507
samson@samsongroup.com · www.samsongroup.com