

# MOUNTING AND OPERATING INSTRUCTIONS



## EB 9511 EN

### Translation of original instructions



## SAM Connect Gateway

For connection to SAM TANK MANAGEMENT

Firmware version 1.02.07



Edition February 2019

## Note on these mounting and operating instructions

These mounting and operating instructions assist you in mounting and operating the device safely. The instructions are binding for handling SAMSON devices.

- For the safe and proper use of these instructions, read them carefully and keep them for later reference.
- If you have any questions about these instructions, contact SAMSON's After-sales Service Department (aftersaleservice@samson.de).



The mounting and operating instructions for the devices are included in the scope of delivery. The latest documentation is available on our website at [www.samson.de](http://www.samson.de) > **Service & Support** > **Downloads** > **Documentation**.

## Definition of signal words

### **DANGER**

*Hazardous situations which, if not avoided, will result in death or serious injury*

### **WARNING**

*Hazardous situations which, if not avoided, could result in death or serious injury*

### **NOTICE**

*Property damage message or malfunction*

### **Note**

*Additional information*

### **Tip**

*Recommended action*

<b>1</b>	<b>Safety instructions and safety measures</b> .....	<b>5</b>
1.1	Notes on possible property damage .....	7
<b>2</b>	<b>Markings on the device</b> .....	<b>8</b>
2.1	Nameplate .....	8
2.2	Article code .....	9
<b>3</b>	<b>Design and principle of operation</b> .....	<b>10</b>
3.1	Configuration using the TROVIS-VIEW software .....	11
3.2	Application .....	11
3.3	Accessories .....	11
3.4	Device overview and operating controls .....	14
3.5	Technical data .....	16
3.6	Dimensions in mm .....	19
3.6.1	Dimensions for mounting (mm) .....	20
<b>4</b>	<b>Measures for preparation</b> .....	<b>21</b>
4.1	Unpacking .....	21
4.2	Transporting and lifting .....	21
4.2.1	Transporting .....	21
4.3	Storage .....	21
<b>5</b>	<b>Mounting and start-up</b> .....	<b>22</b>
5.1	Mounting the SAM Connect Gateway .....	22
5.2	Electrical connections .....	22
5.2.1	Cable glands and terminals .....	22
5.2.2	Connecting the wiring .....	24
<b>6</b>	<b>Option modules</b> .....	<b>26</b>
6.1	Inserting or removing option modules .....	28
6.2	Aligning the antenna .....	30
6.3	Standby power supply (SPS) .....	31
6.3.1	Inserting the battery .....	32
<b>7</b>	<b>Operation</b> .....	<b>34</b>
7.1	Capacitive keys .....	34
7.2	Display .....	35
<b>8</b>	<b>Operating the SAM Connect Gateway</b> .....	<b>36</b>
8.1	First start-up .....	36
8.1.1	Option module wizard .....	36
8.2	Settings .....	37
8.2.1	Setting the user level .....	37

## Contents

8.2.2	Setting the language .....	38
8.2.3	Activating the password protection .....	38
8.2.4	Setting the power line frequency.....	39
8.2.5	Performing option module settings.....	39
8.3	Remote data transmission .....	40
8.3.1	Status LEDs of the GSM module.....	40
8.3.2	Signal quality indication .....	41
<b>9</b>	<b>Servicing.....</b>	<b>42</b>
9.1	Preparation for return shipment.....	42
9.2	Firmware update.....	42
<b>10</b>	<b>Malfunctions .....</b>	<b>43</b>
<b>11</b>	<b>Decommissioning and removal .....</b>	<b>45</b>
11.1	Decommissioning.....	45
11.2	Removing the SAM Connect Gateway .....	45
11.3	Disposal.....	45
<b>12</b>	<b>Appendix.....</b>	<b>46</b>
12.1	After-sales service .....	46
12.2	Menu structure and parameters.....	47

# 1 Safety instructions and safety measures

## Intended use

The modular SAM Connect Gateway allows the input of signals (4 to 20 mA), for example issued by external transmitters. Furthermore, the integrated GSM module allows remote data transmission.

The device is designed to operate under exactly defined conditions (e.g. supply voltage, temperature). Therefore, operators must ensure that the device is only used in operating conditions that meet the specifications used for sizing the device at the ordering stage.

SAMSON does not assume any liability for damage resulting from the failure to use the device for its intended purpose or for damage caused by external forces or any other external factors.

→ Refer to the technical data for limits and fields of application as well as possible uses.

## Reasonably foreseeable misuse

The SAM Connect Gateway is **not** suitable for the following applications:

- Use outside the limits defined during sizing and by the technical data

Furthermore, the following activities do not comply with the intended use:

- Use of non-original spare parts
- Performing maintenance activities not specified by SAMSON

## Qualifications of operating personnel

The device must be mounted, started up and serviced by fully trained and qualified personnel only; the accepted industry codes and practices are to be observed. According to these mounting and operating instructions, trained personnel refers to individuals who are able to judge the work they are assigned to and recognize possible hazards due to their specialized training, their knowledge and experience as well as their knowledge of the applicable standards.

## **Safety instructions and safety measures**

### **Personal protective equipment**

No personal protective equipment is required for the direct handling of the SAM Connect Gateway. Work in the plant may be necessary that requires personal protective equipment.

→ Check with the plant operator for details on personal protective equipment.

### **Revisions and other modifications**

Revisions, conversions or other modifications of the product are not authorized by SAMSON. They are performed at the user's own risk and may lead to safety hazards, for example. Furthermore, the product may no longer meet the requirements for its intended use. Use of the device is no longer permitted.

### **Warning against residual hazards**

To avoid personal injury or property damage, operators and operating personnel must prevent hazards that could be caused in the device by taking appropriate precautions. They must observe all hazard statements, warning and caution notes in these mounting and operating instructions, especially for installation, start-up and service work.

### **Responsibilities of the operator**

The operator is responsible for proper operation and compliance with the safety regulations. Operators are obliged to provide these mounting and operating instructions to the operating personnel and to instruct them in proper operation. Furthermore, the operator must ensure that operating personnel or third persons are not exposed to any danger.

### **Responsibilities of operating personnel**

Operating personnel must read and understand these mounting and operating instructions as well as the specified hazard statements, warning and caution notes. Furthermore, the operating personnel must be familiar with the applicable health, safety and accident prevention regulations and comply with them.

### **Referenced standards and regulations**

Devices with a CE marking fulfill the requirements of the Directives 2014/30/EU and 2014/34/EU. The declarations of conformity are available on request.

### **Referenced documentation**

The following documents apply in addition to these mounting and operating instructions:

- Mounting and operating instructions for connected components (Media 5, Media 6)

## 1.1 Notes on possible property damage

### **!** NOTICE

#### **An incorrect electrical power supply will damage the electronics.**

The SAM Connect Gateway is designed to operate under exactly defined electrical conditions.

- Observe the permissible tolerances of the power supply.
- For wiring, you are required to observe the relevant regulations concerning device safety and electromagnetic compatibility.

#### **Risk of damage to the device due to incorrect mounting position.**

- Mount the device in the upright position only.

#### **Incorrect installation and removal of option modules will damage the SAM Connect Gateway.**

- Before inserting or removing the option modules, disconnect the supply voltage.

#### **Risk of malfunction due to incorrect power line frequency setting.**

The local power line frequency must be entered to be able to properly filter out any disturbances which are transmitted over ground wires or external power supply units.

- Set the local power line frequency by selecting the corresponding parameters.

#### **The use of unapproved batteries will damage the SAM Connect Gateway.**

- Do not use rechargeable batteries in the SAM Connect Gateway.

#### **Risk of device damage due to foreign particles entering it.**

- Do not remove the packaging and protective film/protective caps until immediately before mounting and start-up.

## 2 Markings on the device

### 2.1 Nameplate

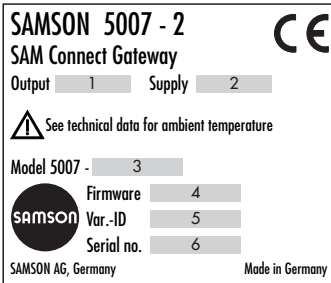

- 1 Signal range
- 2 Electric power supply
- 3 Model no.
- 4 Firmware version
- 5 Configuration ID
- 6 Serial number <sup>1)</sup>

<sup>1)</sup> The first two figures of the serial number in reverse order indicate the year of manufacture (example: serial number 71xxxxx → Year of manufacture = 2017).

#### Option module:

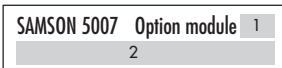

- 1 Abbreviation of optional additional function
- 2 Optional additional function

#### GSM module:

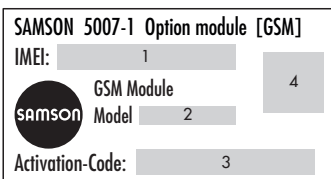

- 1 International Mobile Equipment Identity
- 2 Model no.
- 3 Activation code
- 4 QR code



## 2.2 Article code

SAM Connect Gateway	5007-2- 0 0 0	x	x	x	x	x	x	x	0	x	0	0	0	x	x	x	x	x	x
Power supply																			
Power supply unit, 18 to 36 V DC	1																		
Option module slot 1																			
AI: Analog input	4																		
AlA: Analog input active	6																		
Option module slot 2																			
Without	0																		
AI: Analog input	4																		
AlA: Analog input active	6																		
Option module slot 3																			
Without		0																	
AI: Analog input		4																	
AlA: Analog input active		6																	
Option module slot 4																			
Without			0																
AI: Analog input			4																
AlA: Analog input active			6																
GSM module																			
GSM module with antenna (including SIM card)				2															
Housing material																			
Plastic							0												
Version																			
Standard										0	0								
Hardware version																			
Index: 00														9	9				
Software version																			
V1.02.07																			9 9

### 3 Design and principle of operation

The modular SAM Connect Gateway allows the input of signals (4 to 20 mA), for example issued by external transmitters. For this purpose, four slots exist in the device to hold option modules that can be used for the **AI (analog input)** and/or **AIA (analog input active)** option modules.

**i Note**

At least one option module must always be installed in the SAM Connect Gateway. See section 6 for details on the option modules.

Furthermore, the integrated GSM module allows remote data transmission and connection to the SAM TANK MANAGEMENT web portal.

**Operation**

Four capacitive keys are used to operate the SAM Connect Gateway and allow the user to navigate within the menu on the display.

**Power supply unit with standby power supply (SPS)**

The power supply unit includes a battery compartment for a 1.5 V battery which provides standby power supply upon power failure (see section 6.3).

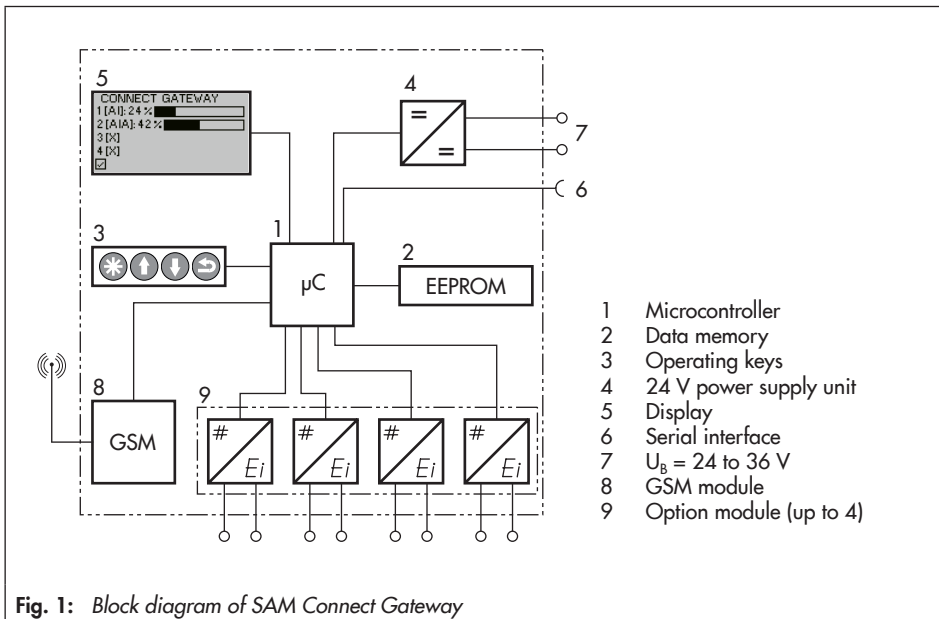

Fig. 1: Block diagram of SAM Connect Gateway

### 3.1 Configuration using the TROVIS-VIEW software

The SAM Connect Gateway can be configured with SAMSON's TROVIS-VIEW Software (version 4). For this purpose, the device has a serial interface (SSP) to allow the USB port of a computer to be connected to it using an adapter cable (order. no. 1400-9740).

The TROVIS-VIEW software enables the user to easily configure the SAM Connect Gateway as well as view process parameters online.

---

**i Note**

*TROVIS-VIEW can be downloaded free of charge from our website at [www.samson.de](http://www.samson.de) > Service & Support > Downloads > TROVIS-VIEW.*

---

### 3.2 Application

The SAM Connect Gateway can accept up to four 4 to 20 mA signals and transfer the data over the integrated GSM module. As a result, transmitters installed in a plant (e.g. Media 5, Media 6 and/or other transmitters by other manufacturers) can be connected to the SAM TANK MANAGEMENT web interface. This allows the filling levels of up to four tanks (Fig. 2) or the filling level and pressure of two tanks (Fig. 3) to be logged and managed on the SAM TANK MANAGEMENT interface.

### 3.3 Accessories

→ Mounting kit for pipe mounting (item no. 1402-1910)

Filling levels of four tanks are transferred to the gateway.

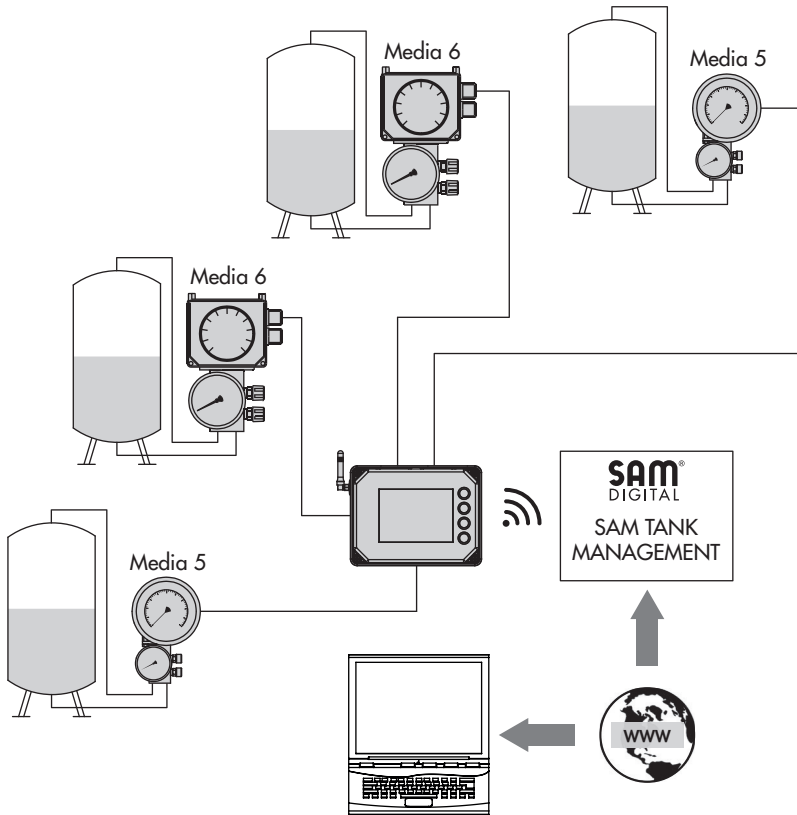
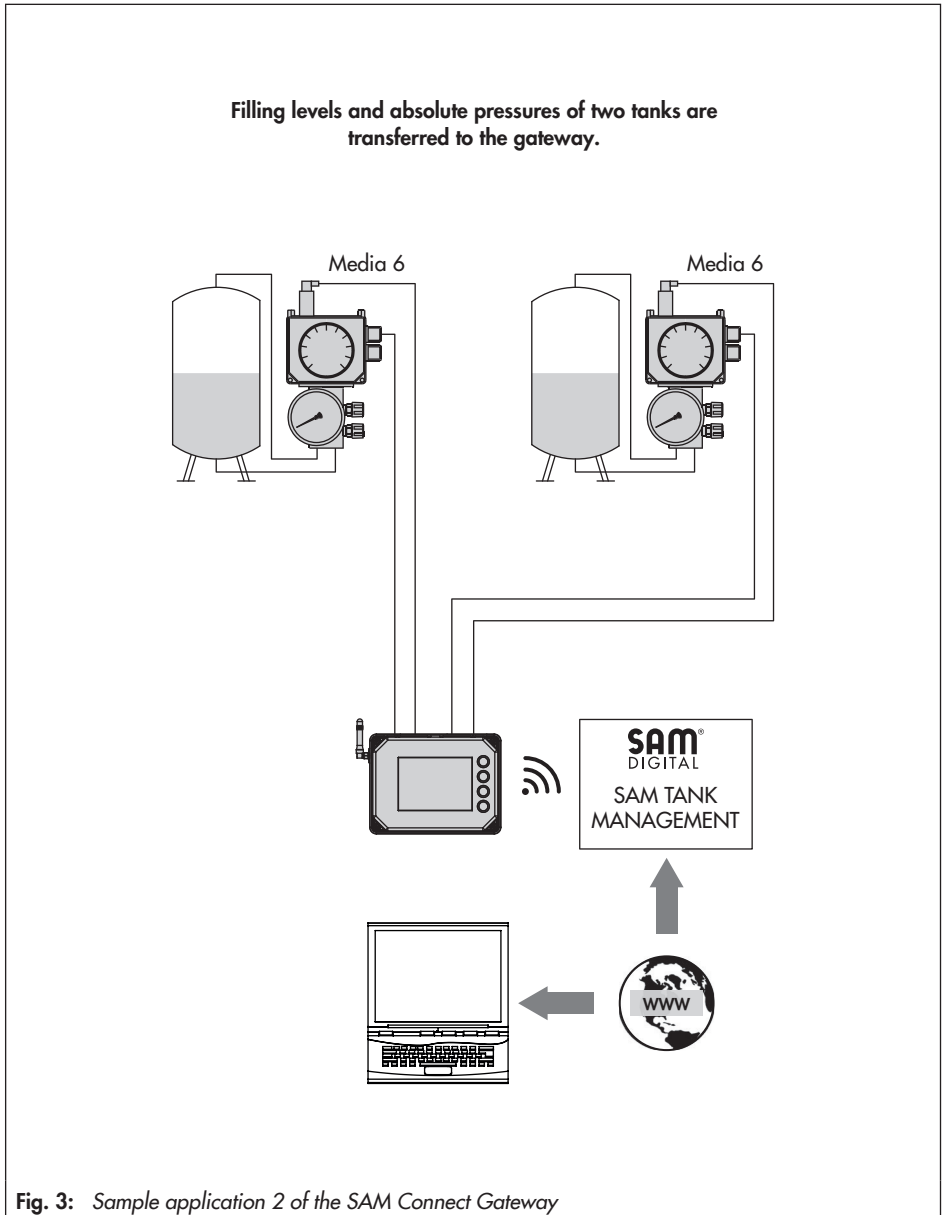

Fig. 2: Sample application 1 of the SAM Connect Gateway



**Fig. 3:** Sample application 2 of the SAM Connect Gateway

### 3.4 Device overview and operating controls

→ Refer to Fig. 4

- 1 Display
- 2 Confirm key
- 3 Up arrow key
- 4 Down arrow key
- 5 Back key
- 6 Error LED
- 7 Battery LED (SPS)
- 8 Status LEDs for GSM module
- 9 Terminal to connect the supply voltage
- 10 GSM module
- 11 SSP interface
- 12 Slots 1 to 4 for option modules
- 13 SPS: standby power supply
- 14 Grounding connection

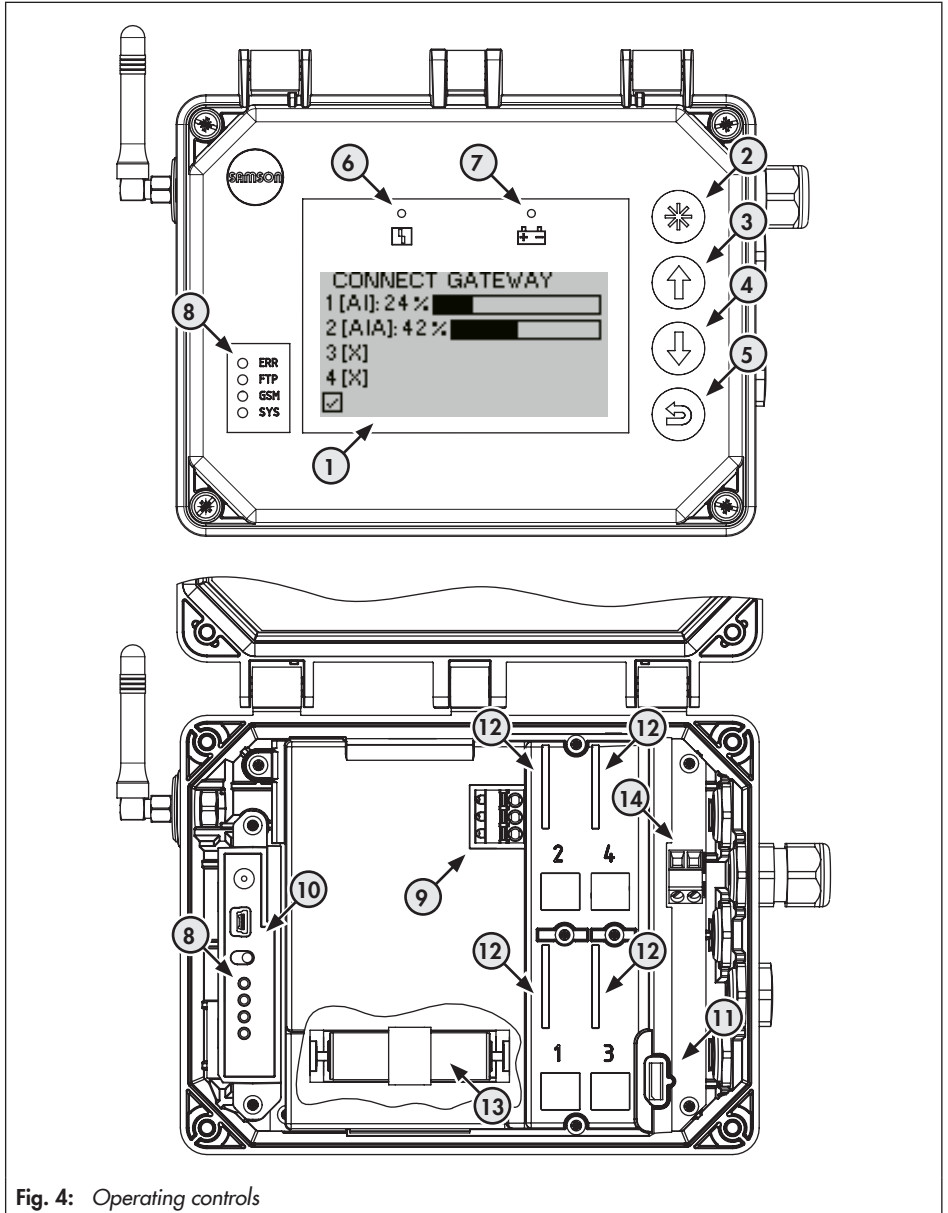

Fig. 4: Operating controls

### 3.5 Technical data

**Table 1:** *General technical data*

<b>SAM Connect Gateway</b>	
Mounting position	Upright with display facing sideways
<b>Display</b>	
Display	LCD 128 x 64 (90 x 40 mm)
Storage temperature	-40 to approx. +80 °C
Operating temperature	-40 to +70 °C
<b>Environmental influences</b>	
Storage according to EN 60721-3-1 (long-term storage)	1K5 (air temperature -40 to +80 °C); 1M3 (The following restriction applies to GSM module: air temperatures -30 to +75 °C)
Transportation according to EN 60721-3-2	2K4 (air temperature -40 to +40 °C in ventilated enclosures, up to +70 °C in unventilated enclosures), 2M1 (The following restriction applies to GSM module for low air temperatures down to -30 °C)
Operation according to EN 60721-3-4 (stationary use at non-weather-protected locations)	4K4 (with restrictions: air temperature -40 to +55 °C, temperature inside the housing must not exceed +70°C when exposed to direct sunlight); 4M4 - The display and GSM module are heated at low air temperatures.
<b>Mechanical vibration</b>	
Vibrations (sinusoidal) according to IEC 60068-2-6	2 to 9 Hz; 3.5 mm amplitude 9 to 200 Hz; 10 m/s <sup>2</sup> acceleration 200 to 500 Hz; 15 m/s <sup>2</sup> acceleration
Random and guidance vibration according to IEC 60068-2-64	1.0 m <sup>2</sup> /s <sup>3</sup> ; 10 to 200 Hz 0.3 m <sup>2</sup> /s <sup>3</sup> ; 200 to 2000 Hz
Shocks according to IEC 60068-2-27	Acceleration 100 m/s <sup>2</sup> ; duration 11 ms
<b>Requirements</b>	
EMC	Devices with a CE marking fulfill the requirements of the Directive 2014/30/EU. Compliance with EN 61000-6-2, EN 61000-6-3, EN 61326-1 and NAMUR Recommendation NE 21.
Degree of protection	IP 67 according to IEC 60529 (VDE 470 Part 1, 2014-09)
<b>Electrical connections</b>	
Cable glands	M16 x 1.5 (max. 5)
Terminals	0.2 to 2.5 mm <sup>2</sup> wire cross-section
Spring-cage terminals (option modules)	0.13 to 1.5 mm <sup>2</sup> wire cross-section



Communication	
Local	SAMSON SSP interface and serial interface adapter, TROVIS-VIEW
Remote data transmission	GSM module
Weight	
Device (with 4 option modules)	Approx. 1400 g

**Table 2:** Power supply

Power supply	
Input voltage	24 to 36 V DC
Output voltage	12 V DC
Power	24 W
Version	Reverse polarity protection

**Table 3:** Optional additional functions

AI: Analog input	
Version	4 to 20 mA current input, externally powered, galvanically isolated, reverse polarity protection
Load impedance	$\leq 5.0$ V external (corresponding to $\leq 200 \Omega$ at 20 mA)
Measuring range	0.1 to 21.6 mA
Accuracy	$\leq 1.0$ %
Resolution	20 $\mu$ A
Temperature influence	0.3 %/10 K
Static destruction limit	38 V DC · 30 V AC
AIA: Analog input active	
Version	4 to 20 mA current input, internally powered, reverse polarity protection
Load impedance	$\leq 1$ V internal (corresponds to $\leq 50 \Omega$ at 20 mA)
Output voltage at the terminal	$\geq 12$ VDC to power external two-wire devices
Measuring range	0.1 to 21.6 mA
Accuracy	$\leq 1.0$ %
Resolution	20 $\mu$ A
Temperature influence	0.3 %/10 K
Static destruction limit	38 V DC · 30 V AC

## Design and principle of operation

GSM module for remote data transmission	
GSM frequency	EGSM 850/900/1800/1900 MHz
Power output	Class 4 (2 W) with 850/900 MHz; Class 1 (1 W) with 1800/1900 MHz
Antenna connection	SMA connector in housing wall
Right-angle antenna	Type 2J010: SMA R/A male
Color	Black
Capacity	25 W
Impedance	50 $\Omega$
Polarization	Vertical
Frequency	GSM (900 MHz), AMPS (824-894 MHz), ISM (868 MHz), DCS (1800 MHz), PCS (1900 MHz), 3G (UMTS 2.1 GHz)
SIM card	M2M Industrial Plug in High Temperature, operating temperature: -40 to +105 °C; Provider: Telefonica Germany GmbH
Operating temperature	-40 to +70 °C (with active heating control)
Storage temperature	-30 to +75 °C
Web interface	SAM TANK MANAGEMENT

**Table 4:** *Materials*

Housing	UV-stabilized polycarbonate
Screws (housing)	Corrosion-resistant steel
Cover (transparent)	UV-stabilized polycarbonate
Screw fastenings (cover)	Corrosion-resistant steel
Cable glands	Polyamide with NBR seal

### 3.6 Dimensions in mm

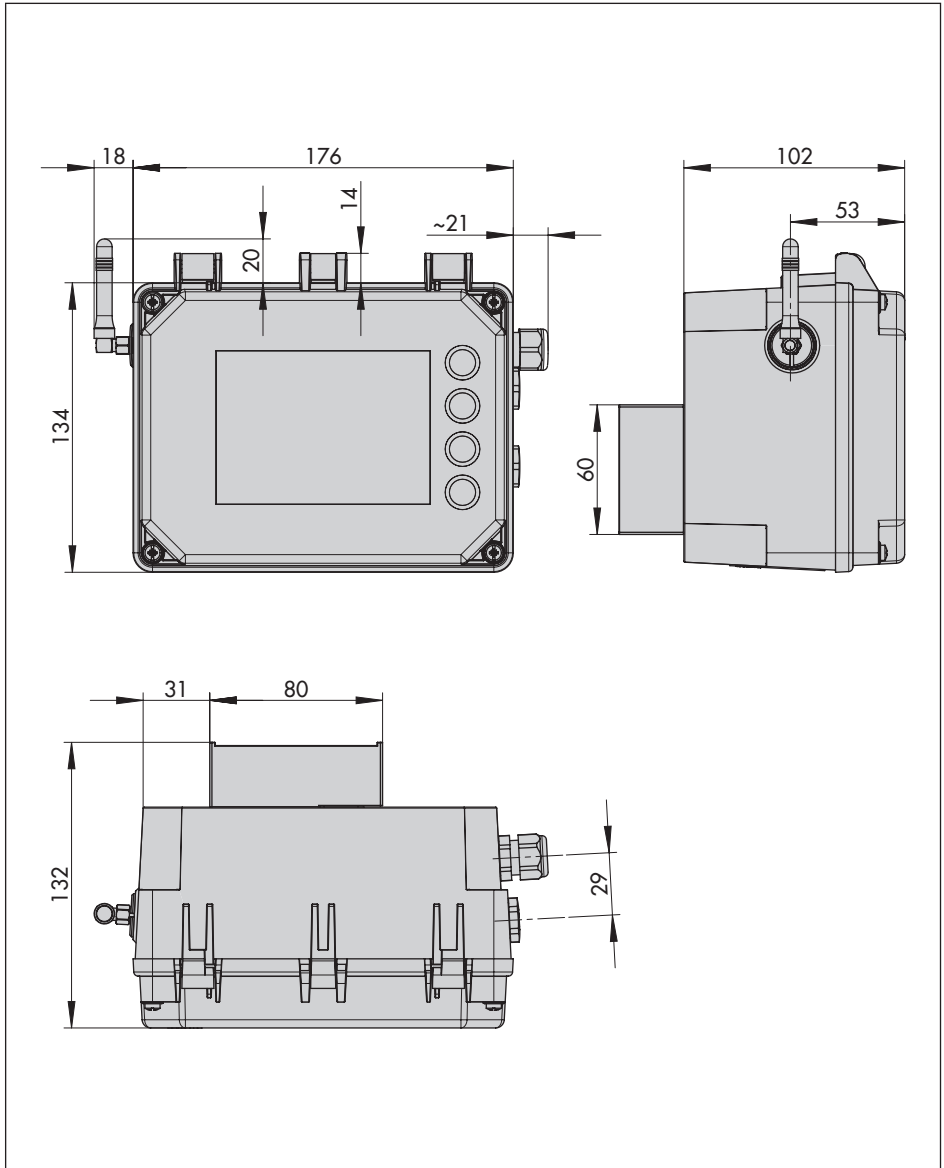

### 3.6.1 Dimensions for mounting (mm)

Dimensions with opened cover:

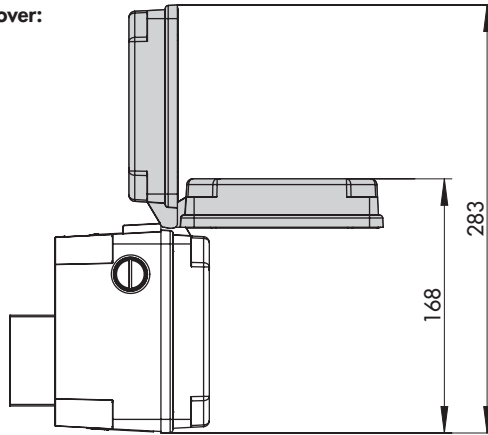

Drill pattern for mounting:

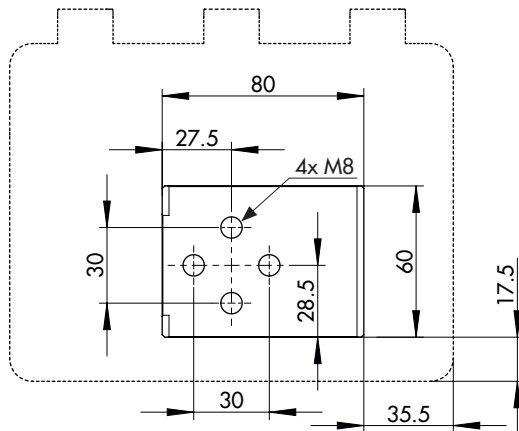

## 4 Measures for preparation

After receiving the shipment, proceed as follows:

1. Check the scope of delivery. Compare the shipment received with the delivery note.
2. Check the shipment for transportation damage. Report any transportation damage.

### 4.1 Unpacking

#### ⓘ NOTICE

*Risk of device damage due to foreign particles entering it.*

*Do not remove the packaging and protective film/protective caps until immediately before mounting and start-up.*

1. Remove the packaging from the device.
2. Dispose of the packaging in accordance with the valid regulations.

### 4.2 Transporting and lifting

#### 4.2.1 Transporting

- Check whether a battery is inserted in the SAM Connect Gateway and remove it before transporting the device.
- Protect the device against external influences (e.g. impact).
- Protect the device against moisture and dirt.

- Observe the permissible transportation temperature of  $-20$  to  $+70$  °C.

### 4.3 Storage

#### ⓘ NOTICE

*Risk of device damage due to improper storage.*

- Observe storage instructions.
- Avoid long storage times.
- Contact SAMSON in case of different storage conditions or long storage periods.

#### Storage instructions

- Protect the SAM Connect Gateway against external influences (e.g. impact).
- Protect the SAM Connect Gateway against moisture and dirt.
- Make sure that the ambient air is free of acids or other corrosive media.
- Observe the permissible storage temperature from  $-20$  to  $+70$  °C.
- Do not place any objects on the device.

### 5 Mounting and start-up

#### NOTICE

*Risk of damage to the device due to incorrect mounting position.*

– Mount the device in the upright position only:

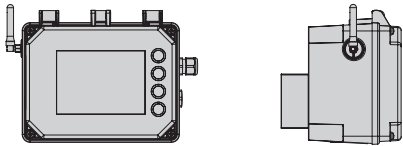

#### 5.1 Mounting the SAM Connect Gateway

The following options to mount the SAM Connect Gateway in the plant are available:

- 4x M8 tapped holes on the back (see section 3.6.1 for hole pattern)
- Kit 1402-1910 for pipe mounting as accessories (see section 3.3 and Fig. 5)

**Additional points that apply concerning installation:**

- Observe mounting position.
- Mount the device free of vibration.
- Use mounting part with clamp for pipe mounting to attach it to a vertical or horizontal pipe.

#### 5.2 Electrical connections

##### Selecting cables and wires

- Use cable glands with M16x1.5 thread whose diameter and shape have been approved by the manufacturer for the cable used.
- Seal cable entries left unused with plugs.
- The cable entry used must correspond with the ambient temperature range and have the specified IP rating (see technical data in section 3.5).

##### 5.2.1 Cable glands and terminals

The housing of the SAM Connect Gateway has five threaded boreholes, which can be fitted with cable glands as required.

- The cable gland version depends on the ambient temperature range. See technical data in section 3.5 on page 16.
- The cage clamp terminals hold wire cross-sections of 0.2 to 2.5 mm<sup>2</sup>.

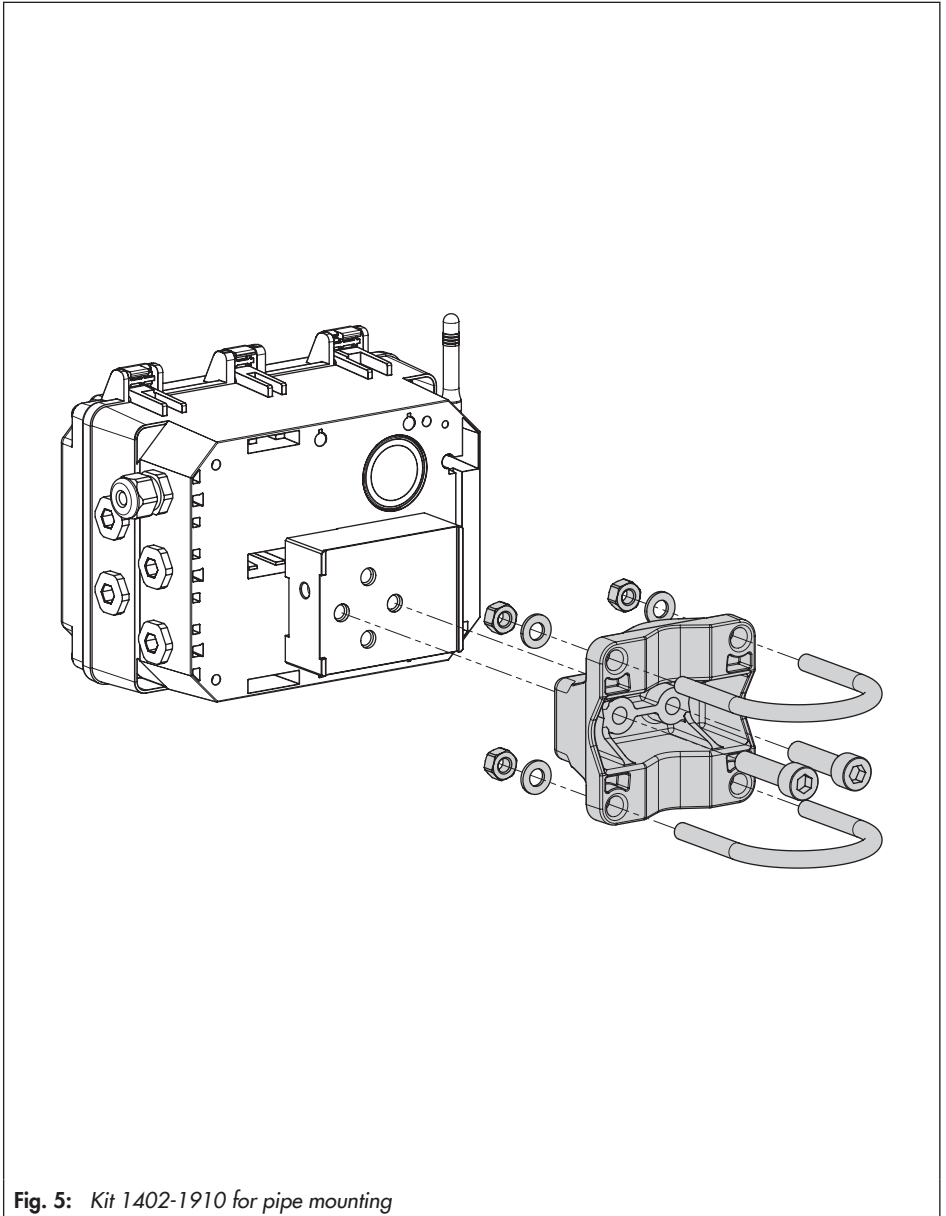

Fig. 5: Kit 1402-1910 for pipe mounting

### 5.2.2 Connecting the wiring

- Connect the wiring as shown in Fig. 6.
- Insert the wire without force.
- To remove the wire, use a slotted screwdriver to press the unlocking slot of the cage clamp terminal and remove the wire.
- Route the grounding connection (PE) to the corresponding terminal.

---

#### **NOTICE**

*Risk of malfunction due to incorrect power line frequency setting.*

*The local power line frequency must be entered to be able to properly filter out any disturbances which are transmitted over ground wires or external power supply units. The power line frequency (50/60 Hz) is entered in menu item 1.6 (see section 8.2.4 on page 39).*

*The procedure to enter or change the parameters is described in section 7 on page 34 onwards.*

---



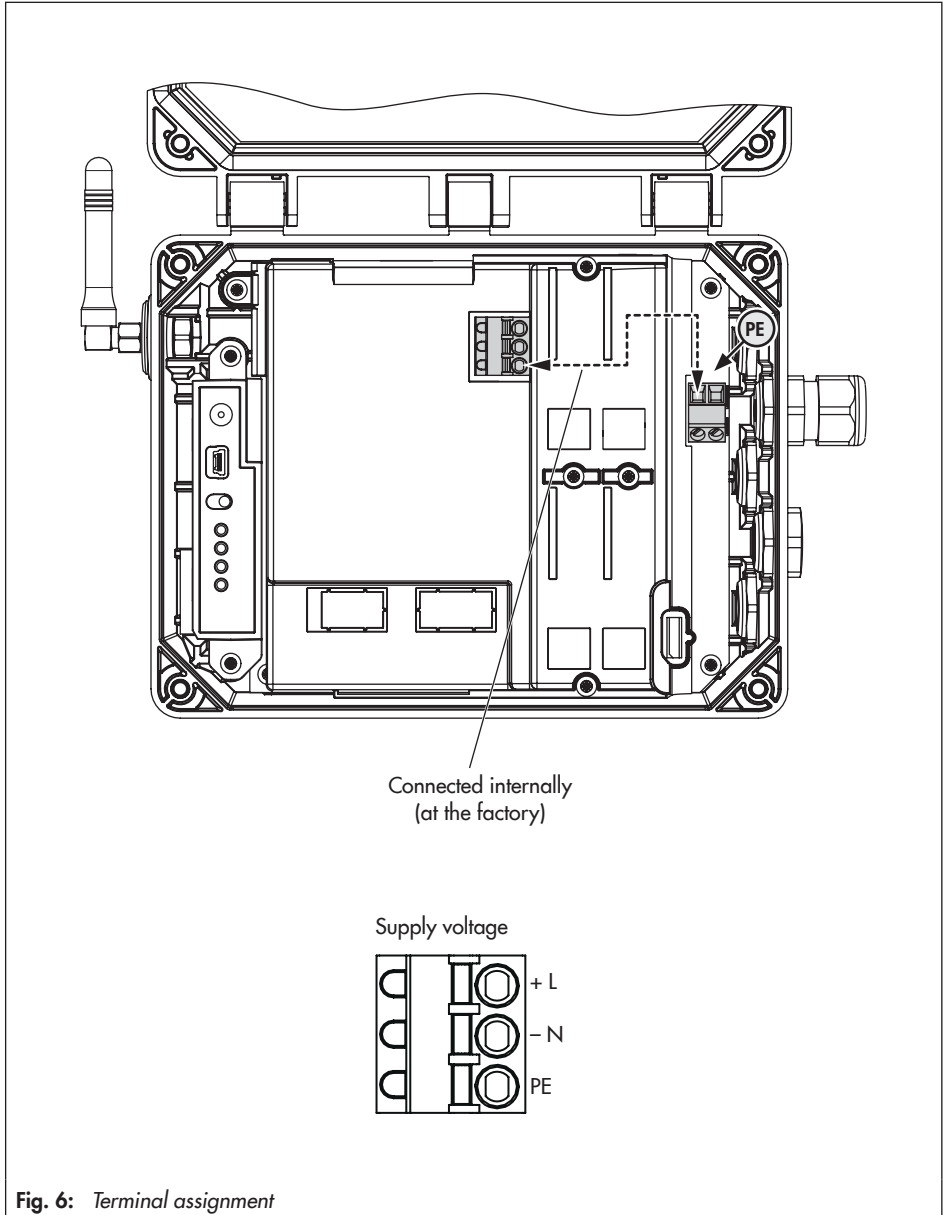

Fig. 6: Terminal assignment

### 6 Option modules

The SAM Connect Gateway provides analog inputs through the use of option modules (Fig. 7, top) to accept (4 to 20 mA) analog signals from filling level or pressure sensors of external equipment. Four slots are available in the device (Fig. 7, bottom).

Upon delivery of the SAM Connect Gateway, at least one option module is installed. Further option modules can be retrofitted. The following option modules are available:

- **AI: Analog input**  
This module works passively and has galvanically isolated inputs. It can accept signals from devices with their own power supply.
- **AIA: Analog input active**  
This module works actively, has a 12 V output to power devices that do not have their own power supply and accepts their signals.

#### Nameplate of the option module:

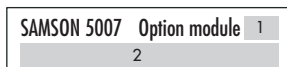

- 1 Abbreviation of optional additional function
- 2 Optional additional function

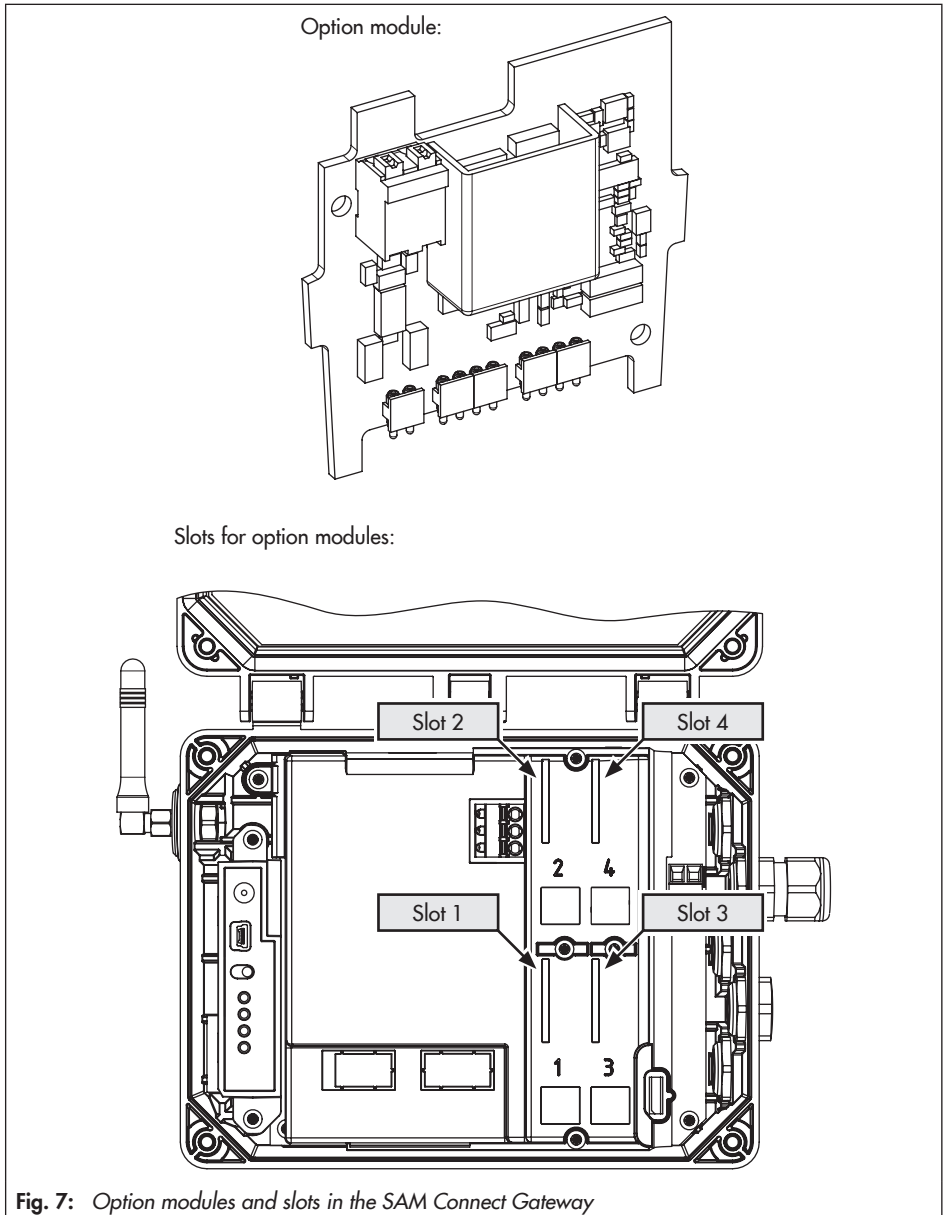

### 6.1 Inserting or removing option modules

#### ! NOTICE

*Incorrect installation and removal of option modules will damage the SAM Connect Gateway.*

*Before inserting or removing the option modules, disconnect the supply voltage.*

#### ! NOTICE

*Electrostatic discharge will damage the option modules.*

*– Observe the ESD requirements according to IEC 61340-5-1.*

*– Only store option modules in their original packaging.*

#### Inserting the option module

→ Refer to Fig. 9

1. Disconnect the supply cable for the supply voltage.
2. Undo the five screws on the cover and remove the cover.
3. Insert the option module in one of the slots, making sure it is inserted correctly.
4. If necessary, break open the openings for the terminals in the cover (by pressing the predetermined breaking points).
5. Place on the cover making sure that the option module is seated in the opening intended for it in the cover.
6. Fasten the cover.
7. Connect the wiring of the option module as shown in Fig. 8.

8. Connect the supply voltage to the SAM Connect Gateway.

#### Removing the option module

1. Disconnect the supply cable for the supply voltage.
2. Disconnect the connecting lines on the option module.
3. Undo the five screws on the cover and remove the cover.
4. Pull the option module out of the slot and store it in its packaging.
5. Place on the cover and fasten it.
6. Connect the supply voltage to the SAM Connect Gateway.

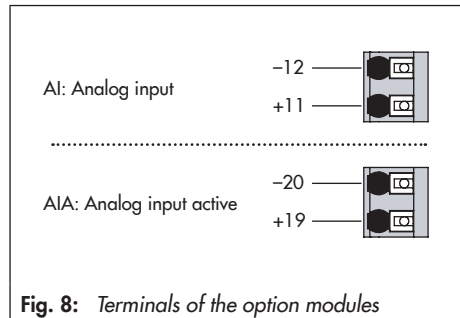

**Fig. 8:** Terminals of the option modules

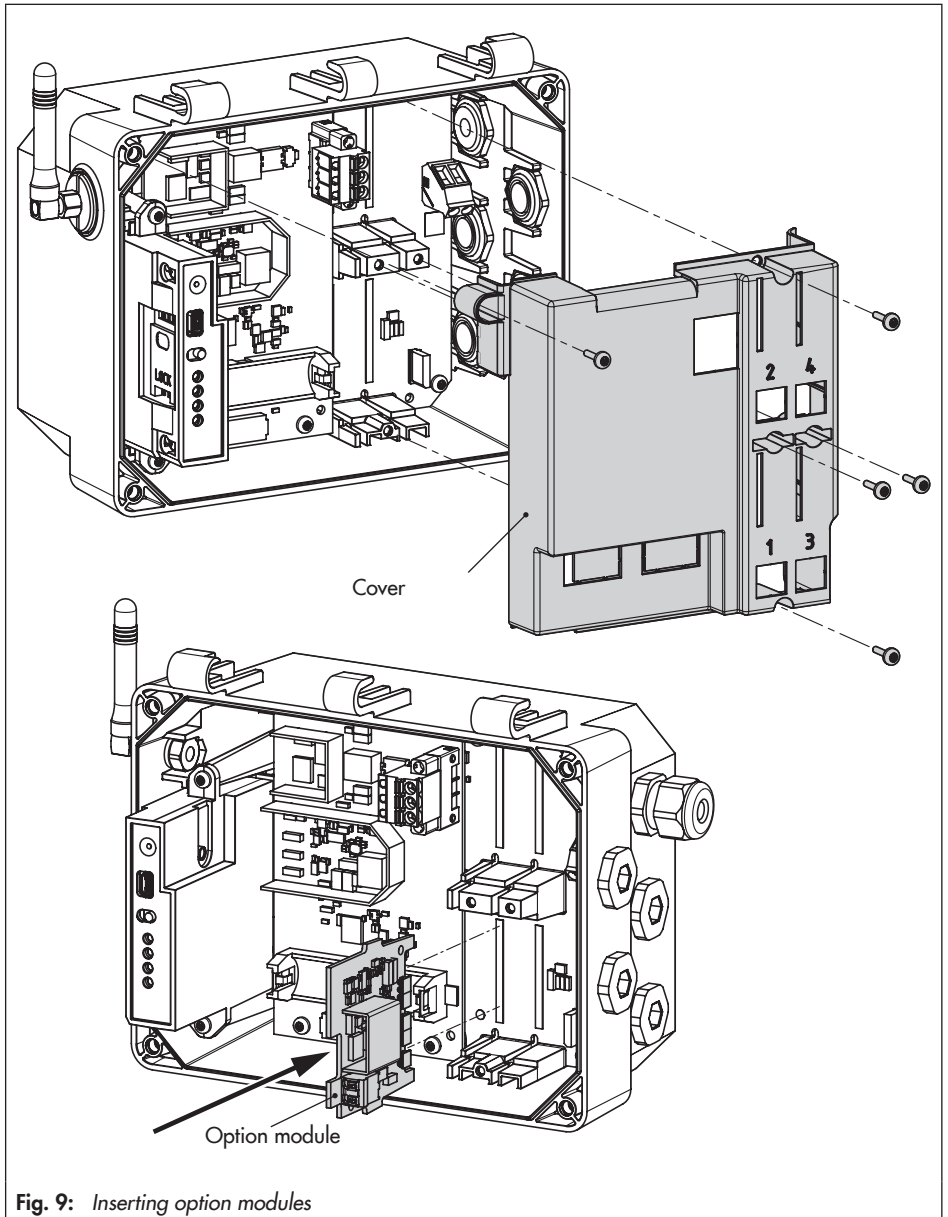

Fig. 9: Inserting option modules

## 6.2 Aligning the antenna

Move the antenna to the upright position for the best reception results. If a weather guard or other housing parts are located directly above the device due to the mounting situation, tilt the antenna slightly.

→ Refer to Fig. 10.

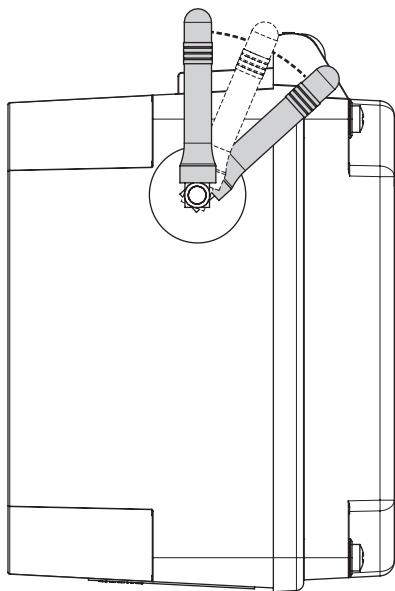

Fig. 10: *Aligning the antenna*

## 6.3 Standby power supply (SPS)

To continue to supply the power supply unit with power after a power failure, we recommend using a battery with the following specifications:

- AA lithium battery (mignon), 1.5 V
- Industrial battery with long service life (min. 3000 mAh recommended)
- Suitable for temperatures from –40 to +60 °C

---

### NOTICE

*The use of unapproved batteries will damage the SAM Connect Gateway.*

**Do not use rechargeable batteries in the SAM Connect Gateway.**

---

### Note

*The battery is not included in the scope of delivery.*

*Operation with standby power supply (SPS) is restricted as follows:*

- The **GSM module** does not function in SPS mode.
  - The **AIA: Analog input active option module** does not supply any voltage.
- 

---

### Tip

*The standby power supply can also be used during the first start-up when no other power supply is available. A lithium battery allows the device to run for approx. seven days.*

---

## 6.3.1 Inserting the battery

---

**NOTICE**

*Incorrect installation and removal of the 1.5 V battery will damage the SAM Connect Gateway.*

*Before inserting or removing the 1.5 V battery, disconnect the supply voltage.*

---

→ Refer to Fig. 11

1. Disconnect the wires for the supply voltage.
2. Undo the five screws on the cover and remove the cover.
3. Place the 1.5 V battery in the battery compartment.

→ **Observe the correct polarity.** A battery symbol with plus and minus signs on the battery compartment indicates the polarity.

4. Place on the cover and fasten it.
5. Connect the supply voltage to the SAM Connect Gateway.



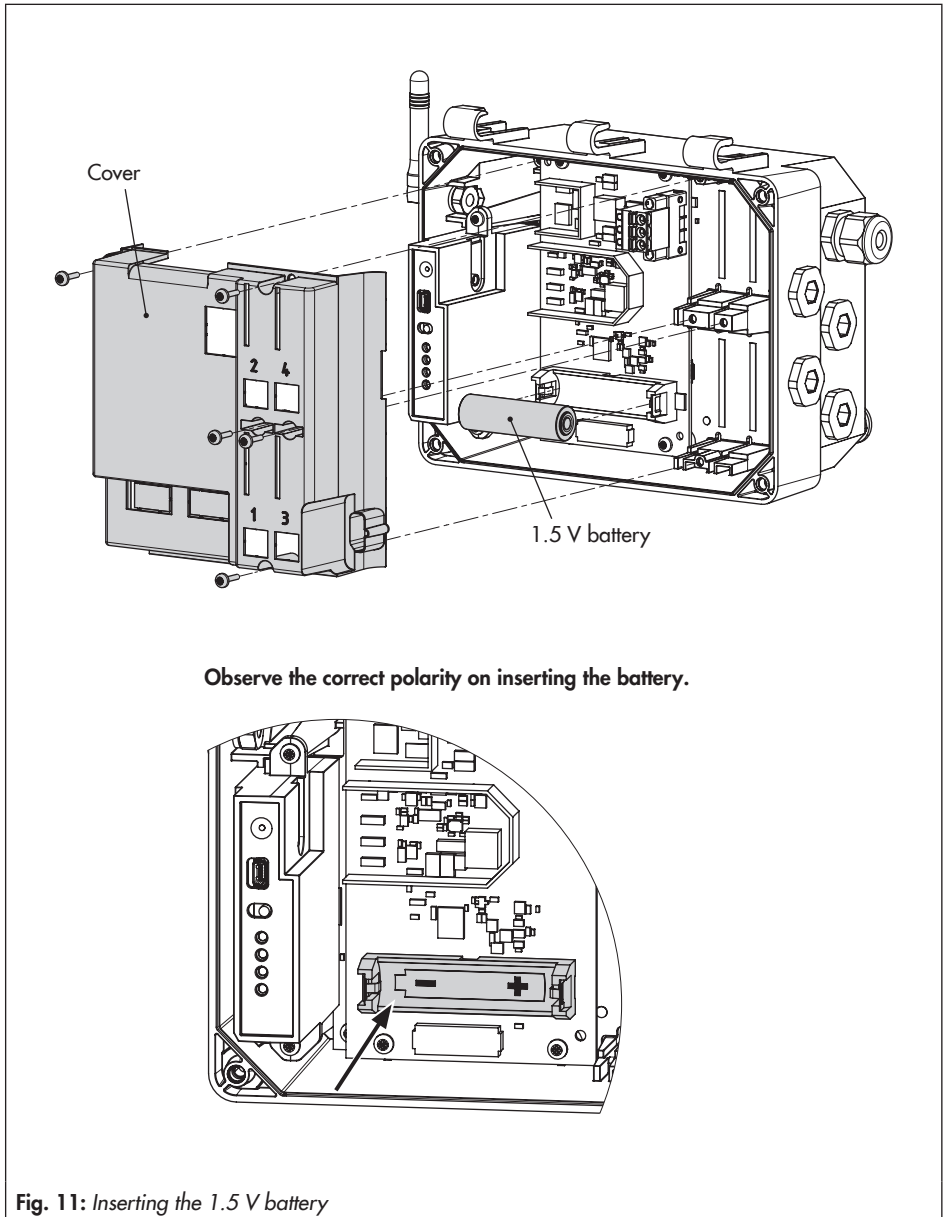
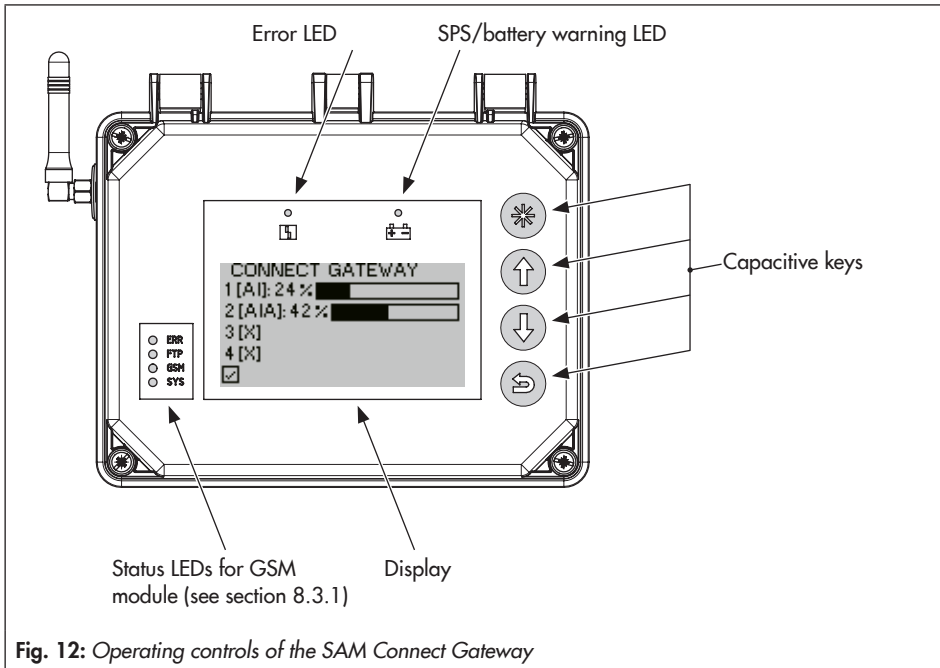





Fig. 11: Inserting the 1.5 V battery

## 7 Operation



### 7.1 Capacitive keys

The capacitive keys for on-site operation are located to the right of the display.

-  Confirm, select, change
-  Scroll upward, increase value
-  Scroll downward, reduce value
-  Back

## 7.2 Display

As soon as the supply voltage is connected, an overview of option modules (see section 8.1) is shown on first start-up or, in all other cases, the start screen (see Fig. 13).

Press  key when the start screen is shown to go to the main menu where settings can be made and process values read. Section 8.2 contains a description of the basic settings. A list of parameters for on-site operation is included in the Appendix (section 12.2 on page 47 onwards).

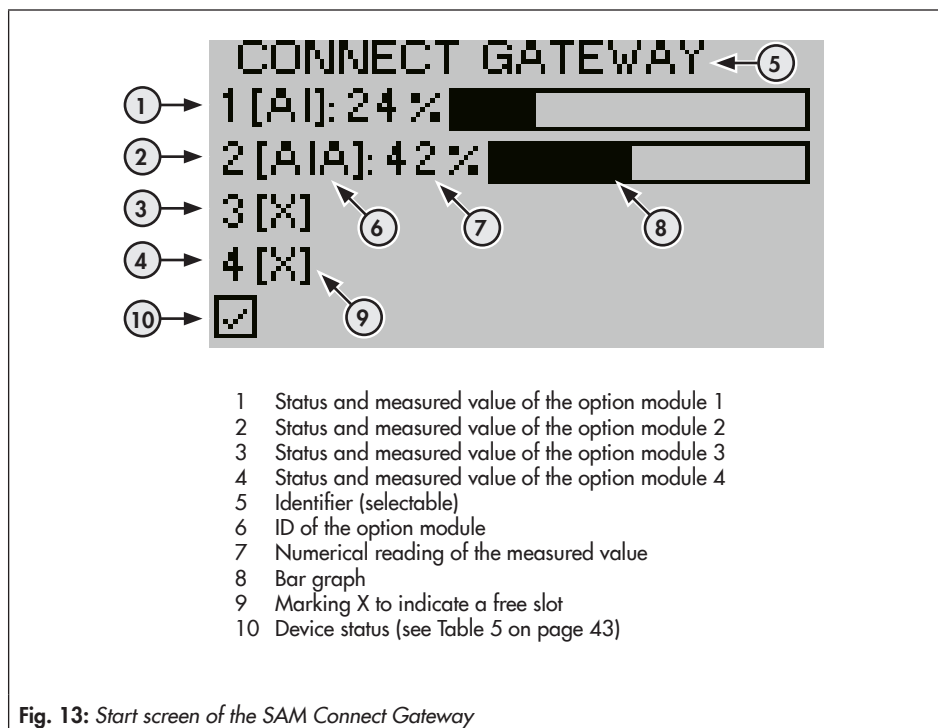

**Fig. 13:** Start screen of the SAM Connect Gateway

# 8 Operating the SAM Connect Gateway

Once the mounting and start-up activities have been completed, you can start with the settings. The SAM Connect Gateway is ready for operation as soon as the supply voltage is connected.

## 8.1 First start-up

When the SAM Connect Gateway is started up for the first time after delivery, an overview of the option modules appears on the display after connecting the supply voltage. The option module wizard can be started in this overview (see section 8.1.1).

---



### **i** Note

- The language is set to English by default on first start-up.
  - If no settings are entered within five minutes, the display returns to the start screen.
- 

### 8.1.1 Option module wizard

On first start-up of the SAM Connect Gateway, an overview of the option modules appears on the display. The option module wizard can be started when this overview is shown.

The overview of the option modules shows the slots for the option modules.

1. Press  or  key to select the required slot or option module.
2. Press  key to confirm the setting.
  - ➔ Depending on the selected option module, diverse settings, such as name, signal source, limit etc., can be made. Descriptions to the parameters can be found in the parameter list (section 12.2) for the corresponding option modules from menu item 2.2 onwards.

**i Note**











- Select **ESC** to exit the option module wizard at any time.
- Select **forward** (>) and **back** (<) to navigate between steps.
- The option module wizard can be started from the Device settings (2) menu/Option modules (2.2)/Overview of option modules (2.2.1 and 2.2.1.1) by selecting a slot/option module ('Specialist' user level only).
- If no settings are entered within five minutes, the display returns to the start screen.

## 8.2 Settings

### 8.2.1 Setting the user level

The SAM Connect Gateway has two user levels with different access privileges:

- **Maintenance staff:** values and parameters can be selected and read in this user level. Changes are not possible in this level.
- **Specialist:** all values can be accessed and parameters changed in this user level. This user level can be password-protected to prevent unauthorized access.











1. Press  key (in start screen) to go to the main menu.
2. Select start-up (1) with  or  key and confirm with  key.
3. Select user level (1.1) with  or  key and confirm with  key.
4. Press  key and select 'Specialist' with  or  key.
5. Press  key to confirm the setting.

### 8.2.2 Setting the language

The following languages are available for selection in the language menu of the SAM Connect Gateway:



















- English · German · French · Italian · Spanish

The language can only be changed in the **Specialist** user level.

1. Press  key (in start screen) to go to the main menu.
2. Select start-up (1) with  or  key and confirm with  key.
3. Select Sprache/Language (1.2) with  or  key and confirm with  key.
4. Press  key and select the required language with  or  key.
5. Press  key to confirm the setting.

### 8.2.3 Activating the password protection







The password (four-digit code) can only be changed and activated in the **Specialist** user level.

1. Press  key (in start screen) to go to the main menu.
2. Select start-up (1) with  or  key and confirm with  key.
3. Select password protection (1.3) with  or  key.
4. Press  key to activate password protection.  
➔ The default password is **1234**. To change the password, proceed as follows:
  1. In the Start-up (1) menu, select Password (1.4) with  or  key and confirm with  key.
  2. Press  key. Select the digit within the password with  or  key.
  3. Press  key. Change the number (0 to 9) within the password with  or  key.
  4. Confirm with  key (proceed in the same way for the rest of the password).
  5. After selecting all digits of the password, press  key.

## 8.2.4 Setting the power line frequency

The local power line frequency must be entered to be able to properly filter out any disturbances which are transmitted over ground wires or external power supply units.











The power line frequency can only be changed in the **Specialist** user level.

1. Press  key (in start screen) to go to the main menu.
2. Select start-up (1) with  or  key and confirm with  key.
3. Select power line frequency (1.6) with  or  key.
4. Press  key to change the setting (50 Hz or 60 Hz).

## 8.2.5 Performing option module settings

The settings of the option module parameters can be performed in the option module wizard (see section 8.1.1) or the device settings.

The option module parameters can only be changed in the **Specialist** user level.

1. Press  key (in start screen) to go to the main menu.
2. Select device settings (2) with  or  key and confirm with  key.
3. Select option modules (2.2) with  or  key and confirm with  key.
4. Select the required slot (2.2.2 to 2.2.5) with  or  key and confirm with  key.
5. Perform settings: the parameters are listed in the Appendix (section 12.2 on page 49 onwards).

### 8.3 Remote data transmission

To use remote data transmission, SAMSON creates a user account for each customer in the SAM TANK MANAGEMENT web interface. All devices are added to the account by SAMSON.

→ Contact SAMSON's After-sales Service department for more information on how to register in SAM TANK MANAGEMENT.

#### 8.3.1 Status LEDs of the GSM module

The table below describes the meaning of the LEDs (see Fig. 12):

LED	Color	Illuminated	Blinks
ERR	Red	Error or failure	2x: GSM module without SIM card 3x: incorrect PIN
FTP	Green		Fast blinking: data transmission in progress
GSM	Green	Searching for a network	1x: GSM connection OK 2x: server connection OK 3x: PIN code failed 4x: hardware error Fast blinking: incoming SMS text message
SYS	Green		1x: system ON







### 8.3.2 Signal quality indication

The signal strength can be indicated by the LEDs on the GSM module.

→ Refer to Fig. 14

1. Press the service key on the GSM module and hold for three seconds.
2. The LEDs indicate the signal strength as follows:

Reading	CSQ value <sup>1)</sup>	Signal quality
Red LED 	< 8 (< -96 dBm)	No signal
Red LED + 1x green LED 	< 15 (< -82 dBm)	Poor quality
Red LED + 2x green LEDs 	< 21 (< -70 dBm)	Fair quality
Red LED + 3x green LEDs 	≥ 21 (≥ -70 dBm)	Good quality

<sup>1)</sup> CSQ (Cell Signal Quality), parameter to indicate the signal strength (signal quality) in mobile networks

**i Note**

If the signal is poor in the location where the device is installed, an external mobile network antenna with SMA connection (commonly available mobile network accessories) can be used.

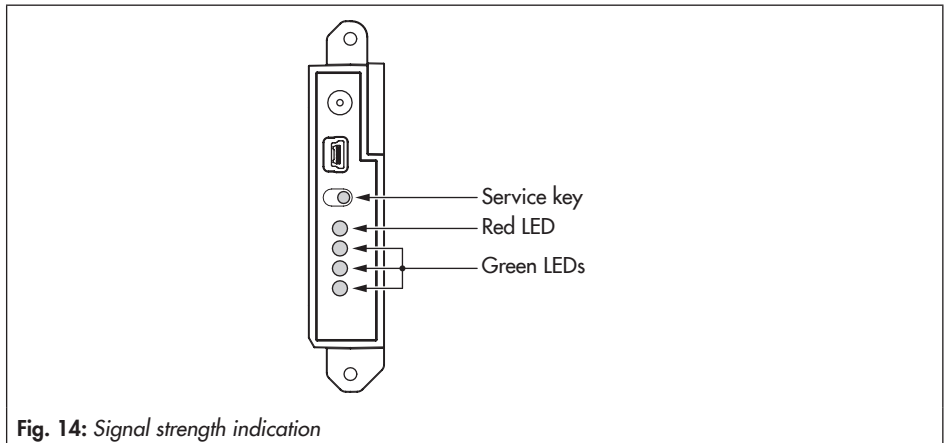

Fig. 14: Signal strength indication

## 9 Servicing

---

### **i** Note

*The SAM Connect Gateway was checked before it left the factory.*

- *The product warranty becomes void if servicing or repair work not described in these instructions is performed without prior agreement by SAMSON's After-sales Service department.*
  - *Only use original spare parts by SAMSON, which comply with the original specifications.*
- 

### 9.1 Preparation for return shipment

Defective devices can be returned to SAMSON for repair.

Proceed as follows to return devices to SAMSON:

1. Remove the SAM Connect Gateway (see section 11).
2. Fill in the Declaration on Contamination. The declaration form can be downloaded from our website at ► [www.samson.de](http://www.samson.de) > Service & Support > After Sales Service.
3. Send the SAM Connect Gateway together with the filled-in form to your nearest SAMSON subsidiary. SAMSON subsidiaries are listed on our website at ► [www.samson.de](http://www.samson.de) (About SAMSON > Sales offices).

### 9.2 Firmware update

Contact your local SAMSON engineering and sales office or subsidiary to request a firmware update. SAMSON subsidiaries are listed on our website at ► [www.samson.de](http://www.samson.de) (About SAMSON > Sales offices).

#### Required specifications





Please submit the following details on requesting a firmware update:

- Type
- Serial number
- Configuration ID
- Current firmware version
- Required firmware version

## 10 Malfunctions

Malfunctions are indicated on the display by error messages in conjunction with an icon for status classification and an error ID. The meaning of the icons and their order of priority are listed in Table 5.

**Table 5:** Icon showing status classification

Status icon	Priority	Meaning
	1	Failure
	2	Out of specification
	3	Maintenance required
	4	No message

In the start screen, error messages can be cleared by pressing the  key. Error messages and recommended action for troubleshooting are listed in Table 6.

**Table 6:** Troubleshooting

Error ID	Message	Possible causes and recommended action
103	Memory error (calibration)	The SAM Connect Gateway has an internal device error. → Contact SAMSON's After-sales Service department.
104	Memory error (data)	
105	No factory calibration	
107	Internal data processing error	
205	Temperature inside device below min. limit	The temperature limit inside the device has fallen below the adjusted min. limit. → Check whether the heating functions properly and the heating control is switched on. → Select lower temperature limit.
206	Temperature inside device above max. limit	The temperature limit inside the device has exceeded the adjusted max. limit. → Check whether the heating functions properly and the heating control is switched on. → Select a better location to mount the device, if necessary.

## Malfunctions

Error ID	Message	Possible causes and recommended action
301	Power supply unit not recognized	<p>The current firmware of the device does not support the supply voltage. A firmware update is necessary.</p> <p>→ Contact SAMSON's After-sales Service department.</p>
302	Option not recognized	<p>The current firmware of the device does not support the option. A firmware update is necessary. The option is defective.</p> <p>→ Contact SAMSON's After-sales Service department.</p>

## 11 Decommissioning and removal

### 11.1 Decommissioning

To decommission the SAM Connect Gateway for removal, proceed as follows:

1. Disconnect the supply voltage.
2. Open the housing cover of the SAM Connect Gateway and disconnect the wires for the power supply.

### 11.2 Removing the SAM Connect Gateway

1. Disconnect the wires for the supply voltage from the SAM Connect Gateway.
2. To remove the SAM Connect Gateway, loosen the fastening screws.

### 11.3 Disposal



We are registered with the German national register for waste electric equipment (stiftung ear) as a producer of electrical and electronic equipment, WEEE reg. no.: DE 62194439

- ➔ Do not dispose of components, lubricants and hazard substances together with your other household waste.
- ➔ Check whether a battery is inserted in the SAM Connect Gateway and remove it before disposing of the device.
- ➔ Observe local, national and international refuse regulations before disposing of the device and its batteries.

---

#### Note

*We can provide you with a recycling passport according to PAS 1049 on request. Simply e-mail us at [aftersalesservice@samson.de](mailto:aftersalesservice@samson.de) giving details of your company address.*

---

#### Tip

*On request, we can appoint a service provider to dismantle and recycle the product.*

---

# 12 Appendix

## 12.1 After-sales service

Contact SAMSON's After-sales Service department for support concerning service or repair work or when malfunctions or defects arise.

### E-mail address

You can reach the After-sales Service Department at [aftersaleservice@samson](mailto:aftersaleservice@samson).

### Addresses of SAMSON AG and its subsidiaries

The addresses of SAMSON AG, its subsidiaries, representatives and service facilities worldwide can be found on our website ([www.samson.de](http://www.samson.de)) or in all SAMSON product catalogs.

### Required specifications

Please submit the following details:

- Order number and position number in the order
- Type, serial number
- Firmware version

## 12.2 Menu structure and parameters

### **i** Note

The availability of executed menu items and parameters depends on the user level (parameter 1.1), the configuration and the option modules used.

Menu		Adjustment range/values/description
<b>Start-up</b>	<b>1</b>	
User level	1.1	Select user level <ul style="list-style-type: none"> <li>▪ Maintenance staff: restricted access</li> <li>▪ Specialist: full access (password protection possible in menu item 1.7)</li> </ul>
Sprache/Language	1.2	Select the menu and display language: <ul style="list-style-type: none"> <li>▪ German/English (default)/French/Italian/Spanish</li> </ul>
Password protection	1.3	The 'Specialist' user level can be protected by a four-digit code (menu item 1.4). <ul style="list-style-type: none"> <li>▪ Not active</li> <li>▪ Active</li> </ul>
Password	1.4	Enter a four-digit code <ul style="list-style-type: none"> <li>▪ 0000 to 9999</li> </ul>
Write protection (data transmission module)	1.5	Activate write protection (data transmission module) <ul style="list-style-type: none"> <li>▪ Yes</li> <li>▪ No</li> </ul>
Power line frequency	1.6	Adapt to the power line frequency <ul style="list-style-type: none"> <li>▪ 50 Hz (default)</li> <li>▪ 60 Hz</li> </ul>
<b>Device settings</b>	<b>2</b>	
<b>General</b>	<b>2.1</b>	
Identifier	2.1.1	Enter a freely selectable code for the device (max. 15 characters) <ul style="list-style-type: none"> <li>▪ Enter characters as required (default: CONNECT GATEWAY)</li> </ul>
LCD backlight	2.1.2	The LCD backlight can be switched on or off. <ul style="list-style-type: none"> <li>▪ ON</li> <li>▪ OFF</li> </ul>

Menu	Adjustment range/values/description
LCD deactivation time      2.1.3	<p>The LCD of the SAM Connect Gateway can be switched off after the entered deactivation time (see 2.1.4, only when the OFF setting is selected).</p> <ul style="list-style-type: none"> <li>▪ ON (default)</li> <li>▪ OFF</li> </ul>
Deactivation time            2.1.4	<p>Enter the time after which the LCD is to be automatically switched off.</p> <ul style="list-style-type: none"> <li>▪ 1 to 10 min (default: 10 min)</li> </ul>
LCD heating control        2.1.5	<p>The 'ON' setting causes the display to be heated when the outdoor temperature is low. The power consumption of the device increases by <b>510 mA</b> when the heating is activated.</p> <p>Upper switching temperature (deactivate): -12.5 °C  Lower switching temperature (activate): -17.5 °C</p> <ul style="list-style-type: none"> <li>▪ ON (default)</li> <li>▪ OFF</li> </ul>
Option 1 display            2.1.6	<p>The value of the analog input signal of option module 1 can be displayed numerically with a unit or as a bar graph on the start screen.</p> <ul style="list-style-type: none"> <li>▪ Bar graph (default)</li> <li>▪ Numerical</li> </ul>
Option 2 display            2.1.7	<p>The value of the analog input signal of option module 2 can be displayed numerically with a unit or as a bar graph on the start screen.</p> <ul style="list-style-type: none"> <li>▪ Bar graph (default)</li> <li>▪ Numerical</li> </ul>
Option 3 display            2.1.8	<p>The value of the analog input signal of option module 3 can be displayed numerically with a unit or as a bar graph on the start screen.</p> <ul style="list-style-type: none"> <li>▪ Bar graph (default)</li> <li>▪ Numerical</li> </ul>
Option 4 display            2.1.9	<p>The value of the analog input signal of option module 4 can be displayed numerically with a unit or as a bar graph on the start screen.</p> <ul style="list-style-type: none"> <li>▪ Bar graph (default)</li> <li>▪ Numerical</li> </ul>











Menu		Adjustment range/values/description
<b>Option modules</b>	<b>2.2</b>	
Overview of option modules	2.2.1	
	2.2.1.1	Overview of option modules in four slots as graph, starts option module wizard
Slot 1	2.2.2	<i>The available parameters of inserted options modules are listed depending on the optional additional function.</i>
Slot 2	2.2.3	
Slot 3	2.2.4	
Slot 4	2.2.5	
<b>AI: Analog input/AIA: Analog input active</b>		
Option module identification	... .1	Detection of optional additional function: AI: Analog input
Option module status	... .2	Read the current status of the option module <ul style="list-style-type: none"> <li>▪ No module inserted</li> <li>▪ Module not permissible in this setup</li> <li>▪ Module unknown</li> <li>▪ Module active</li> </ul>
Name	... .3	Enter a name (max. 15 characters) for identification.
Signal source	... .4	Enter the signal source on which the 4 to 20 mA signal is based <ul style="list-style-type: none"> <li>▪ Unknown (default)</li> <li>▪ Filling level</li> <li>▪ Pressure</li> <li>▪ Temperature</li> </ul>
Medium identifier	... .5	Enter a name (max. 15 characters) to identify the medium. The parameter is only visible when the signal source is set to <i>Filling level</i> . <ul style="list-style-type: none"> <li>▪ Enter characters as required (default: MEDIUM)</li> </ul>
Measured value	... .6	Display the current measured value in the selected unit
Unit	... .7	Unit in which the measured value is to be indicated. <ul style="list-style-type: none"> <li>▪ Selectable units: % · kg · Nm<sup>3</sup> · L · ft<sup>3</sup> · lbs · mbar · bar · kPa · psi · mmH<sub>2</sub>O · cmH<sub>2</sub>O · mH<sub>2</sub>O · inH<sub>2</sub>O · °C · °F · K</li> </ul>
Lower measuring range value	... .8	Determine the lower limit of the measuring range at 4 mA (depending on the selected unit)
Upper measuring range value	... .9	Determine the upper limit of the measuring range at 20 mA (depending on the selected unit)

## Appendix

Menu		Adjustment range/values/description
Event: Broken cable	... .10	<p>Activates or deactivates the event for a detected cable breakage at the input of the AI option module. The event is activated when the signal falls below the switching threshold of 0.2 mA.</p> <ul style="list-style-type: none"> <li>▪ ON (default)</li> <li>▪ OFF</li> </ul>
Event: Residual current	... .11	<p>Activates or deactivates the event for a detected residual current violation at the input of the AI option module. The event is activated when the signal falls below the switching threshold of 3.6 mA or exceeds 21.0 mA.</p> <ul style="list-style-type: none"> <li>▪ ON (default)</li> <li>▪ OFF</li> </ul>
Limit 1	... .12	<p>Activate/deactivate limit 1</p> <ul style="list-style-type: none"> <li>▪ ON (default)</li> <li>▪ OFF</li> </ul>
Mode	... .13	<p>An upper limit can be determined with 'Max. contact' and a lower limit with 'Min. contact' for limit 1.</p> <ul style="list-style-type: none"> <li>▪ Max. contact</li> <li>▪ Min. contact</li> </ul>
Limit	... .14	<p>Setting limit 1</p> <ul style="list-style-type: none"> <li>▪ The limit is set in % when the signal source parameter is set to 'Unknown' or 'Filling level'.</li> </ul>
Limit	... .15	<p>Setting limit 1</p> <ul style="list-style-type: none"> <li>▪ The limit is set in % when the signal source parameter is set to 'Unknown' or 'Filling level'.</li> </ul>
Limit 2	... .16	<p>Activate/deactivate limit 2</p> <ul style="list-style-type: none"> <li>▪ ON (default)</li> <li>▪ OFF</li> </ul>
Mode	... .17	<p>An upper limit can be determined with 'Max. contact' and a lower limit with 'Min. contact' for limit 2.</p> <ul style="list-style-type: none"> <li>▪ Max. contact</li> <li>▪ Min. contact</li> </ul>
Limit	... .18	<p>Setting limit 2</p> <ul style="list-style-type: none"> <li>▪ The limit is set in % when the signal source parameter is set to 'Unknown' or 'Filling level'.</li> </ul>

Menu		Adjustment range/values/description
Limit	... .19	Setting limit 2 <ul style="list-style-type: none"> <li>▪ The limit is set in % when the signal source parameter is set to 'Unknown' or 'Filling level'.</li> </ul>
Limit 3	... .20	Activate/deactivate limit 3 <ul style="list-style-type: none"> <li>▪ ON (default)</li> <li>▪ OFF</li> </ul>
Mode	... .21	An upper limit can be determined with 'Max. contact' and a lower limit with 'Min. contact' for limit 3. <ul style="list-style-type: none"> <li>▪ Max. contact</li> <li>▪ Min. contact</li> </ul>
Limit	... .22	Setting limit 3 <ul style="list-style-type: none"> <li>▪ The limit is set in % when the signal source parameter is set to 'Unknown' or 'Filling level'.</li> </ul>
Limit	... .23	Setting limit 3 <ul style="list-style-type: none"> <li>▪ The limit is set in % when the signal source parameter is set to 'Unknown' or 'Filling level'.</li> </ul>
4 to 20 mA measured value	... .24	Read the current (in mA) at the option module
Relative measured value	... .25	Read the current (in %) at the option module
Start test	... .26	Executable function to indicate a signal in the device and can be tested over the web interface. The input signal of the option module is replaced by an internal test signal and issued by the GSM module.
Test mode	... .27	Test mode is <i>Active</i> while the test is in progress (test duration: 30 s). <ul style="list-style-type: none"> <li>▪ Not active</li> <li>▪ Active</li> </ul>
Test signal of analog output	... .28	Test signals (depending on the selected unit) based on the 4 to 20 mA signal range.

Menu	Adjustment range/values/description
Zero point ... .29	<p>The zero correction allows the input value to be corrected by <math>\pm 10\%</math> at the maximum. The zero correction is always performed before the span correction. The following functions are available:</p> <ul style="list-style-type: none"> <li>▪ Set zero: zero is set to the current input value (e.g. 3 %) and the measured value is set to 0 %.</li> <li>▪ Reset zero: zero is set to 0 %.</li> </ul> <p>The following values are displayed:</p> <ul style="list-style-type: none"> <li>▪ Measured value (analog input signal) in %</li> <li>▪ Currently adjusted zero</li> <li>▪ Measured value (analog input signal) in mA</li> </ul>
Span ... .30	<p>The span correction allows the input value to be corrected by <math>\pm 20\%</math> at the maximum. Always perform a zero correction before the span correction. The following functions are available:</p> <ul style="list-style-type: none"> <li>▪ Set span: span is set to the current input value (e.g. 103 %) and the measured value is set to 100 %.</li> <li>▪ Reset span: span is set to 0 %.</li> </ul> <p>The following values are displayed:</p> <ul style="list-style-type: none"> <li>▪ Measured value (analog input signal) in %</li> <li>▪ Currently adjusted span</li> <li>▪ Measured value (analog input signal) in mA</li> </ul>
Zero shift ... .31	Zero shift reading in %
Span offset ... .32	Span offset reading in %
<b>Identification</b>	<b>2.3</b>
Firmware version 2.3.1	Read the current firmware version of the SAM Connect Gateway
Serial number of the entire device 2.3.2	Read the serial number of the SAM Connect Gateway
Serial number of option 1 2.3.3	Read the serial number of the option module in slot 1
Serial number of option 2 2.3.4	Read the serial number of the option module in slot 2
Serial number of option 3 2.3.5	Read the serial number of the option module in slot 3
Serial number of option 4 2.3.6	Read the serial number of the option module in slot 4
Voltage supply 2.3.7	<p>Display the type of voltage supply</p> <ul style="list-style-type: none"> <li>▪ Unknown</li> <li>▪ 24 V DC</li> </ul>

Menu		Adjustment range/values/description			
HW version/supply voltage	2.3.8	Read the hardware version of the voltage supply			
Explosion protection certification	2.3.9	▪ No (the SAM Connect Gateway does not have any explosion protection certificates).			
<b>Process data</b>		<b>3</b>			
Identifier	3.1	Read the entered identifier			
Temperature inside device	3.2	Read the current temperature in °C			
Heating	3.3	Reading ON/OFF			
Battery voltage	3.4	Read the battery voltage in V			
<b>Diagnostics</b>		<b>4</b>			
Status messages	4.1	<p>Status messages provide an overview on the current states of individual functions or components of the SAM Connect Gateway. A corresponding status icon is assigned to failures and error messages.</p> <p>  Failure (error class E1)   Out of specification (error class E2)   Maintenance required (error class E3)   No message </p>			
Possible status					
Media condensed state	4.1.1	•	•	•	•
Condensed state (E1)	4.1.2	•			•
103: Memory (calibration)	4.1.3	•			•
104: Memory (data)	4.1.4	•			•
105: Factory calibration	4.1.5	•			•
107: Data processing	4.1.6	•			•

## Appendix

Menu		Adjustment range/values/description		
Condensed state (E2)	4.1.7		•	•
205: Min. temperature	4.1.8		•	•
206: Max. temperature	4.1.9		•	•
Condensed state (E3)	4.1.10		•	•
301: Power supply unit	4.1.11			•
302: Option not recognized	4.1.12			•
<b>Diagnostic data</b>		<b>4.2</b>		
Operation duration	4.2.1	Read the entire operating time of the device (dd:hh:mm:ss)		
<b>Temperature</b>		<b>4.3</b>		
Temperature inside device	4.3.1	Read the current device temperature in °C		
Max. temperature inside device	4.3.2	<p>Set an upper temperature limit within the specified range. If the current device temperature is above the adjusted limit, an error message is generated and displayed. The status changes to 'Out of specification'.</p> <ul style="list-style-type: none"> <li>▪ 10 to 80 °C (default: 70 °C)</li> </ul>		
Min. temperature inside device	4.3.3	<p>Set a lower temperature limit within the specified range. If the current device temperature is below the adjusted limit, an error message is generated and displayed. The status changes to 'Out of specification'.</p> <ul style="list-style-type: none"> <li>▪ -40 to +10 °C (default: -40 °C)</li> </ul>		



**EB 9511 EN**



SAMSON AKTIENGESELLSCHAFT  
Weismüllerstraße 3 · 60314 Frankfurt am Main, Germany  
Phone: +49 69 4009-0 · Fax: +49 69 4009-1507  
samson@samson.de · www.samson.de